

20

TWENTY YEARS  
MANUFACTURING QUALITY LED LIGHTING SOLUTIONS



 **TecNiq**<sup>inc</sup>  
*Changing the Shape of Light*<sup>™</sup>



TecNiq was formed in 2004 with one simple focus in mind.

To create the most efficient & cost saving LED products available.

By collecting and directing the LEDs light, we continue to make the highest quality LED products, right here in the USA.

---









At TecNiq we take great pride in the quality of materials and components that we utilize. From the highest quality LEDs, and FR-4 circuit boards - the materials and processes we use help us keep our customers "Cost of Ownership" down. In addition, we take our customers success just as seriously as we do the products that we make. Whether your an OEM business, large scale fleet, upfitter, or just getting started – TecNiq provides consistent, reliable, high quality LED performance. The business relationships we build with our customers reflect back on our “Customer for Life” motto, ensuring that we remain your trusted partner for all of your lighting needs. Our goal is always 100% satisfaction with our products, service and support.

**This is the commitment that drives every aspect of our business.**





# TABLE OF CONTENTS

|   |   |        |
|---|---|--------|
|    | Over 80" ID Bars & Stop/Tail/Turn .....   | 1-14   |
|    | Clearance & Side Markers .....            | 15-25  |
|    | Reverse Lamps .....                       | 25-27  |
|    | License Plate Lamps & Brackets .....      | 27-30  |
|    | Strobes & Flashers .....                  | 30-36  |
|    | Scene & Task Lighting .....               | 37-44  |
|    | Area/Accent Lighting .....                | 45-52  |
|    | Dome & Interior Lighting .....            | 53-61  |
|    | Slim Lines & Strip Lighting .....         | 62-65  |
|  | Electrical, Harnesses & Accessories ..... | 66-70  |
|  | Reference/Index .....                     | 71-120 |



TecNiq is proud to Engineer, Design, Manufacture and Assemble here in the USA. Per the FTC, no company producing LED lighting in the USA should tell you they are "Made in the USA", as the primary component, LEDs, are not made in the US. However, at TecNiq we pride ourselves in producing our own circuit boards, as well as doing our own injection molding of lenses and bodies in-house.



The IP code or ingress protection code indicates how well a device is protected against water and dust. The "6" refers to being Dust-tight or No ingress of dust; complete protection against contact (dust-tight). A vacuum must be applied. Test duration of up to 8 hours based on airflow. The 8 refers to Immersion, 1 meter (3 ft 3 in) or more depth, meaning The equipment is suitable for continuous immersion in water under conditions which the manufacturer shall specify.



These two symbols represent the type of operating voltage that an individual light runs on. These symbols are not meant to represent the exact current draw at all times.



*Summary:* FMVSS 108 is a federal regulation standard that refers to Lamps, Reflective Devices, and Associated Equipment. This Standard applies to MPVs, trucks, buses and trailers (except pole trailers and trailer converter dollies). It specifies type, location, and performance requirements for original and replacement lamps, reflective devices and associated equipment.



## S50 – Heavy Duty Identification Bar



- Submersible over 80" ID bar
- Available in colored or clear lens
- Reliable over 100,000 hours

- **WIRE COLORS**  
**White/Colored Stripe** – Ground,  
**Black** – Positive

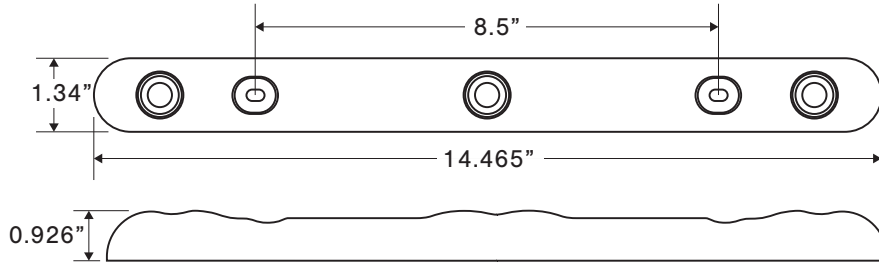

| Part No.   | Part Description (Please see Index, or <a href="http://www.TecNiqInc.com">www.TecNiqInc.com</a> for a complete part list) | Amp Draw    | Color | Pack |
|------------|---|-------------|-------|------|
| S50-AAB0-1 | S50 Tri-Bar Amber Amber Lens Black Body   | 0.18A-0.24A |       | 25   |
| S50-ACB0-1 | S50 Tri-Bar Amber Clear Lens Black Body   |             |       | 25   |
| S50-RCB0-1 | S50 Tri-Bar Red Clear Lens Black Body   |             |       | 25   |
| S50-RRB0-1 | S50 Tri-Bar Red Red Lens Black Body   |             |       | 25   |

Over 80" ID Bars & Stop/Tail/Turn



## S51 – Heavy Duty Identification Bar



- Submersible over 80" ID bar
- Design matches S18 side marker
- Available in colored or clear lens
- Reliable over 100,000 hours

- **WIRE COLORS**  
**White/Colored Stripe** – Ground,  
**Black** – Positive

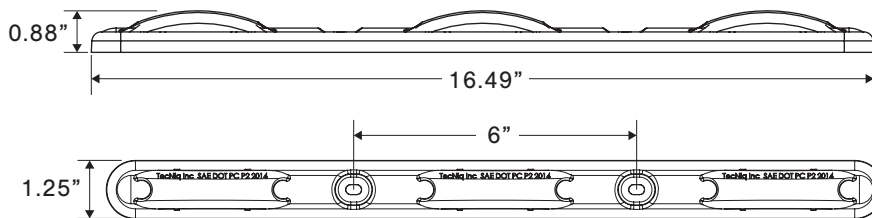

| Part No.   | Part Description (Please see Index, or <a href="http://www.TecNiqInc.com">www.TecNiqInc.com</a> for a complete part list) | Amp Draw    | Color | Pack |
|------------|---|-------------|-------|------|
| S51-AA00-1 | S51 Tri-Bar Amber Amber Lens Black Body S18 Markers   | 0.16A-0.20A |       | 25   |
| S51-AC00-1 | S51 Tri-Bar Amber Clear Lens Black Body S18 Markers   |             |       | 25   |
| S51-RC00-1 | S51 Tri-Bar Red Clear Lens Black Body S18 Markers   |             |       | 25   |
| S51-RR00-1 | S51 Tri-Bar Red Red Lens Black Body S18 Markers   |             |       | 25   |





# T10 – Slim Line Stop/Tail/Turn

- Reliable over 100,000 hours
- Can be mounted horizontal, vertical, or at any angle

**• WIRE COLORS**

- White** – Ground,
- Red/Amber** – High/Turn,
- Black** – Low/Dim

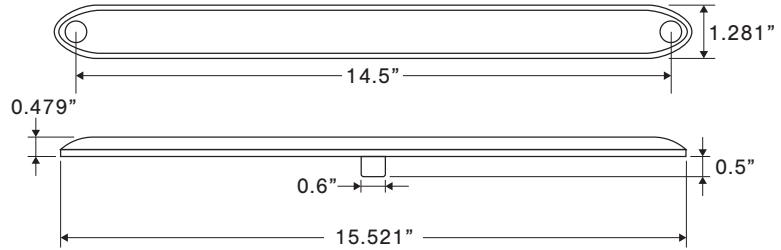

| Part No.   | Part Description (Please see Index, or <a href="http://www.TecNiqInc.com">www.TecNiqInc.com</a> for a complete part list) | Amp Draw    | Color | Pack |
|------------|---|-------------|-------|------|
| T10-AA00-1 | Amber Low Profile Turn Sidemarker Amber Lens  | 0.17A-0.23A |       | 100  |
| T10-AC00-1 | Amber Low Profile Turn Sidemarker Clear Lens  | 0.17A-0.23A |       | 100  |
| T10-LC00-1 | Low Profile Auxiliary Light   | 0.31A-0.38A |       | 100  |
| T10-RC00-1 | Red Low Profile STT Clear Lens  | 0.11A-0.23A |       | 100  |



# T12 – Heavy Duty Identification Bar

- Reliable over 100,000 hours
- Guaranteed circuit board protection
- Automotive grade polycarbonate

**• WIRE COLORS**

- White** – Ground,
- Red/Amber** – High/Turn,
- Black** – Low/Dim

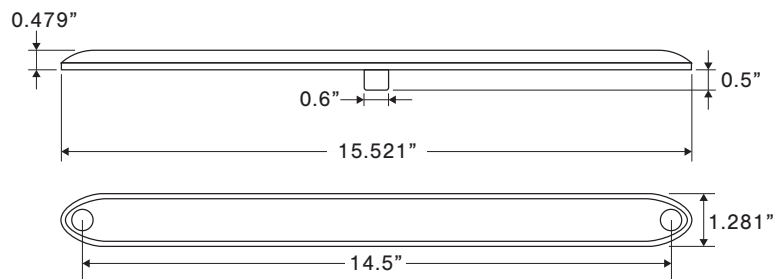

| Part No.   | Part Description (Please see Index, or <a href="http://www.TecNiqInc.com">www.TecNiqInc.com</a> for a complete part list) | Amp Draw    | Color | Pack |
|------------|---|-------------|-------|------|
| T12-AA00-1 | Amber Low Profile ID Bar Amber Lens   | 0.04A-0.07A |       | 100  |
| T12-AC00-1 | Amber Low Profile ID Bar Clear Lens   | 0.04A-0.07A |       | 100  |
| T12-RC00-1 | Red Low Profile ID Bar Clear Lens   | 0.04A-0.07A |       | 100  |
| T12-RR00-1 | Red Low Profile ID Bar Red Lens   | 0.04A-0.07A |       | 100  |

Over 80" ID Bars & Stop/Tail/Turn



## T14 – Over 80” ID Bar/Load Lamp

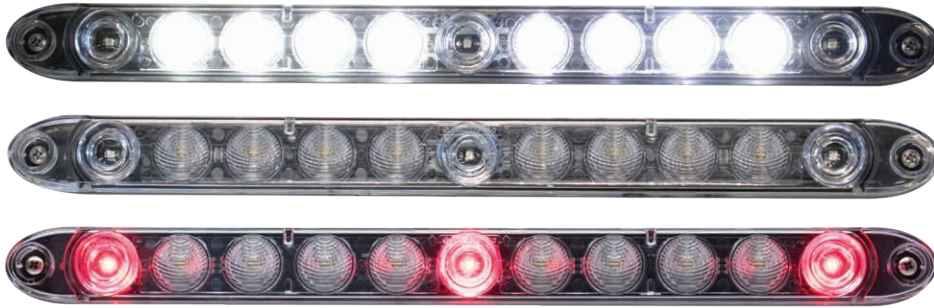

- High output – 500 Lumens
- Over 80” ID & Load Light
- Red LEDs for Rear Clearance
- High Impact Lens
- Surface mount install
- **AVAILABLE IN SMOKED/ TINTED LENS**
- **DOT Rated**

• **WIRE COLORS**

**White** - Ground, **Black** - Low, **Red** - High, **Yellow** - Load Lamp

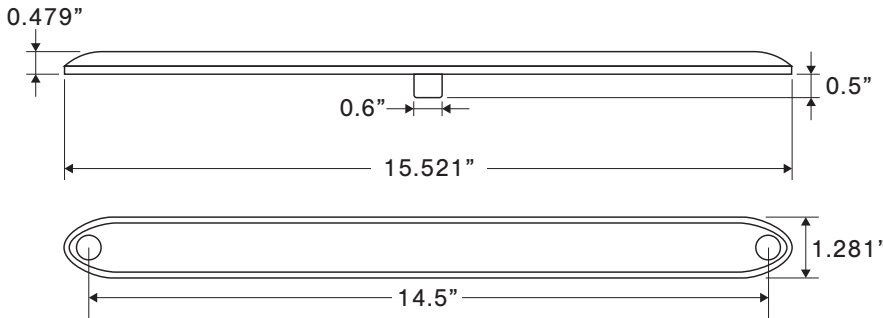

| Part No.   | Part Description (Please see Index, or <a href="http://www.TecNiqInc.com">www.TecNiqInc.com</a> for a complete part list) | Amp Draw                  | Color  | Pack |
|------------|---|---------------------------|--|------|
| T14-RW00-1 | Identification and Load Lamp Combo  | 0.04A-0.07A +0.3A (white) | <input checked="" type="checkbox"/> <input type="checkbox"/> | 100  |
| T14-RT00-1 | Identification and Load Lamp Combo - Tinted   |                           | <input type="checkbox"/> <input type="checkbox"/>            | 100  |

Over 80” ID Bars & Stop/Tail/Turn



## T15 – Slim Line Stop/Turn/Tail/Reverse



- STT & Reverse in one light
- Mount horizontally, vertically, or at any angle
- Red LEDs for Rear Clearance
- Surface mount install
- **AVAILABLE IN SMOKED/ TINTED LENS**

• **WIRE COLORS**

**White** - Ground, **Red** - Stop/Turn, **Black** - Tail, **Yellow** - Reverse

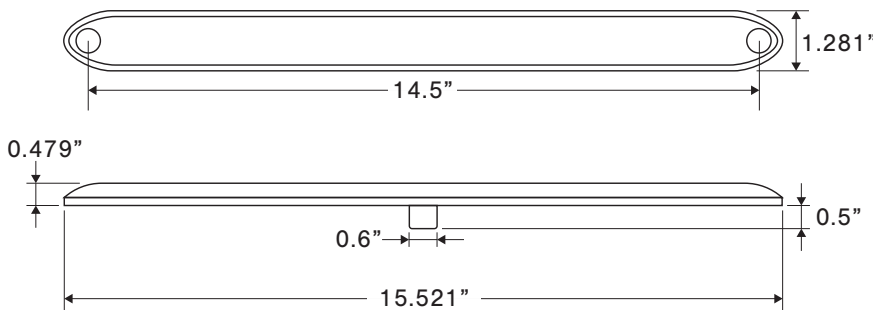

| Part No.   | Part Description (Please see Index, or <a href="http://www.TecNiqInc.com">www.TecNiqInc.com</a> for a complete part list) | Amp Draw                  | Color  | Pack |
|------------|---|---------------------------|--|------|
| T15-RW0-1  | Low profile Red LED Clear Lens with Reverse   |                           | <input checked="" type="checkbox"/> <input type="checkbox"/> | 25   |
| T15-RCWB-1 | Low profile Red LED Clear Lens with Reverse with .180 bullets   | 0.11A-0.15A / 0.30A (rev) | <input checked="" type="checkbox"/> <input type="checkbox"/> | 25   |
| T15-RWTP-1 | Low Profile Red Tinted Lens with Reverse  |                           | <input checked="" type="checkbox"/> <input type="checkbox"/> | 25   |





# T16 – 20” Slim Line Stop/Tail/Turn/Reverse

- All-in-one combination light
- Slender design accommodates larger door openings
- **AVAILABLE IN SMOKED/ TINTED LENS**
- **DOT Rated**



\* Also available WITHOUT Reverse

### • WIRE COLORS

**White** - Ground, **Red** - Stop/Turn,  
**Black** - Tail, **Yellow** - Reverse

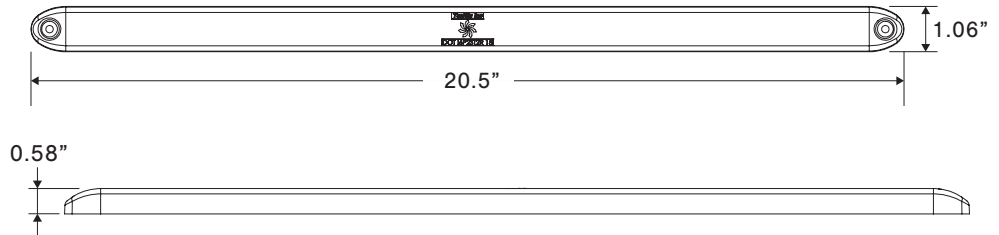

| Part No.   | Part Description (Please see Index, or <a href="http://www.TecNiqInc.com">www.TecNiqInc.com</a> for a complete part list) | Amp Draw                     | Color | Pack |
|------------|---|------------------------------|-------|------|
| T16-RCW0-1 | 20" slim profile clear lens STTR  | 0.07A-0.10A \ 0.20A<br>(rev) |       | 100  |
| T16-RR00-1 | 20" slim profile Red lens STT   |                              |       | 100  |
| T16-RC00-1 | 20" slim profile clear lens STT   |                              |       | 100  |
| T16-RWT0-1 | 20" Slim Profile Tinted Lens STTR   |                              |       | 100  |



# T40 – 4” Round Standard Stop/Tail/Turn

- Available in hardwired pigtail, standard connectors, or custom connectors for easy install
- Industry standard 4” round
- High Impact Lens
- **DOT Rated**

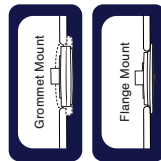

\* Flange mount with SS trim

### • WIRE COLORS

**White** - Ground, **Red** - Stop/Turn,  
**Black** - Tail

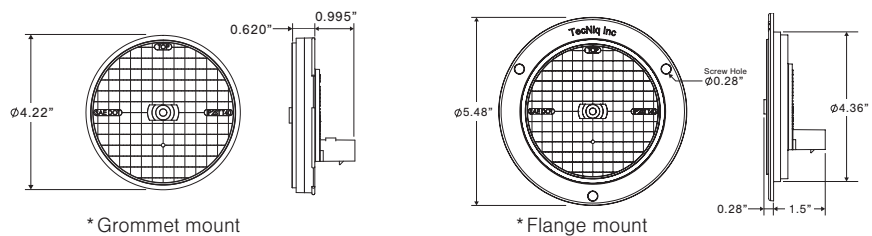
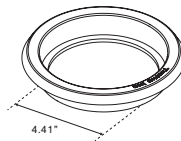

\* Grommet mount

\* Flange mount

| Part No.   | Part Description (Please see Index, or <a href="http://www.TecNiqInc.com">www.TecNiqInc.com</a> for a complete part list) | Amp Draw    | Color | Pack |
|------------|---|-------------|-------|------|
| T40-AA0P-1 | 4" Round Amber Turn Lamp Amber Lens w/Pig Tail  | 0.17A-0.23A |       | 100  |
| T40-AAFP-1 | 4" Round Amber Turn Lamp Amber Lens Flange Mount w/Pig Tail   |             |       | 100  |
| T40-RR0P-1 | 4" Round STT Lamp Red Lens w/Pig Tail   |             |       | 100  |
| T40-RRFP-1 | 4" Round STT Red Lens Flange Mount w/Pig Tail   |             |       | 100  |



# T42 – 4" Round High Visibility Stop/Tail/Turn/Reverse

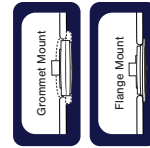

- Available with **Amp** or **Tri-Pole** connectors
- Industry standard 4" round
- High impact resistant lens
- Grommet or flange mount
- Reliable over 100,000 hours
- **DOT Rated**

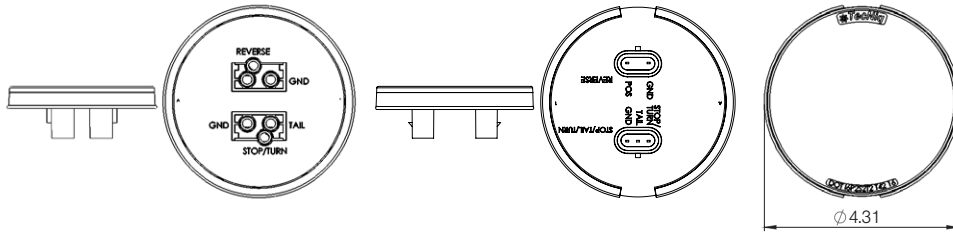

| Part No.   | Part Description (Please see Index, or <a href="http://www.TecNiqInc.com">www.TecNiqInc.com</a> for a complete part list) | Amp Draw  | Color | Pack |
|------------|---|---|-------|------|
| T42-RW0A-1 | 4" Round STTR Clear Lens Grommet Mount Amp  | 0.23A-0.31A (brake) / 0.1A (tail) / 0.33A-0.44A (rev) |       | 100  |
| T42-RW0T-1 | 4" Round STTR w Large Reverse Grommet Mount Tripole   | 0.33A-0.44A (rev)                                     |       | 100  |
| T40-0G00-1 | 4" Round Grommet  |   |       | 100  |
| T40-0G20-1 | 4" Round Grommet High Grip  |   |       | 100  |

Over 80" ID Bars & Stop/Tail/Turn



# T45 – 4" Round High Visibility Stop/Tail/Turn/Reverse

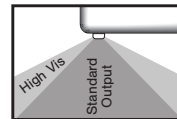

- STT & Reverse in one light
- High Visibility gives increased brightness off-angle for greater safety
- Fits standard 4" applications
- **DOT Rated**

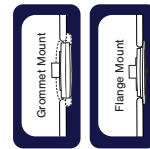

- **WIRE COLORS**  
**White** - Ground, **Red** - Stop/Turn, **Black** - Tail, **Yellow** - Reverse

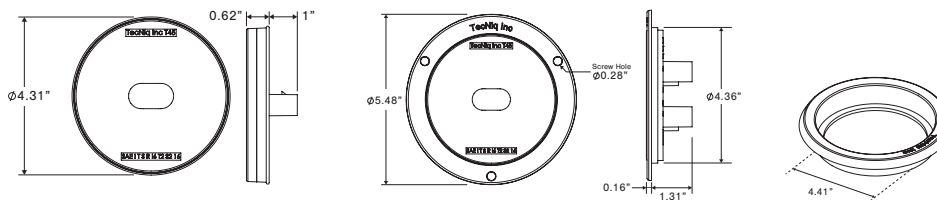

| Part No.   | Part Description (Please see Index, or <a href="http://www.TecNiqInc.com">www.TecNiqInc.com</a> for a complete part list) | Amp Draw                     | Color | Pack |
|------------|---|------------------------------|-------|------|
| T45-RC0P-1 | 4" Round STTR Clear Lens Grommet Mount Pigtail  |                              |       | 100  |
| T45-RCFP-1 | 4" Round STTR Clear Lens Flush Mount Pigtail  | 0.11A-0.15A / 0.3A (reverse) |       | 100  |
| T45-RW0P-1 | 4" Round STTR Red Lens Grommet Mount Pigtail  |                              |       | 100  |
| T45-RWFP-1 | 4" Round STTR Red Lens Flush Mount Pigtail  |                              |       | 100  |





# T46 – 4” Round High Visibility Stop/Tail/Turn

- Fits standard 4” applications
- Impact resistant lens
- Grommet or flange mount
- High Visibility gives increased brightness off-angle for greater safety

**• WIRE COLORS**

**White** - Ground, **Red** - Stop/Turn, **Black** - Tail

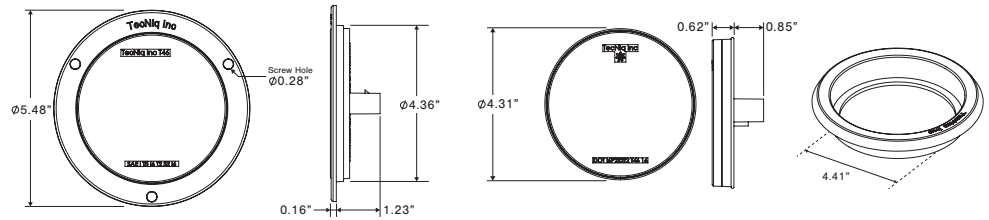

| Part No.   | Part Description (Please see Index, or <a href="http://www.TecNiqInc.com">www.TecNiqInc.com</a> for a complete part list) | Amp Draw    | Color | Pack |
|------------|---|-------------|-------|------|
| T46-AA0T-1 | Hi Visibility 4" Round Amber STT Amber Lens Tri Pole Conn. Grommet Mt   | 0.14A-0.18A |       | 100  |
| T46-AC0T-1 | Hi Visibility 4" Round Amber STT Clear Lens Tri Pole Conn. Grommet Mt   |             |       | 100  |
| T46-RC0T-1 | Hi Visibility 4" Round STT Clear Lens Tri Pole Grommet Mt   | 0.11A-0.15A |       | 100  |
| T46-RCFT-1 | Hi Visibility 4" Round STT Clear Lens Tri Pole Flange Mt  |             |       | 100  |



# K20 – 7” Round High Visibility Lights

**NEW PRODUCT**

- Fits standard 7” applications
- Red, Amber or Clear lens options
- Grommet or flange mount
- **Stop/Tail/Turn, Warning, Reverse & Turn Signals**
- **DOT Rated**

**• WIRE COLORS**

**White** - Ground, **Black** - Positive

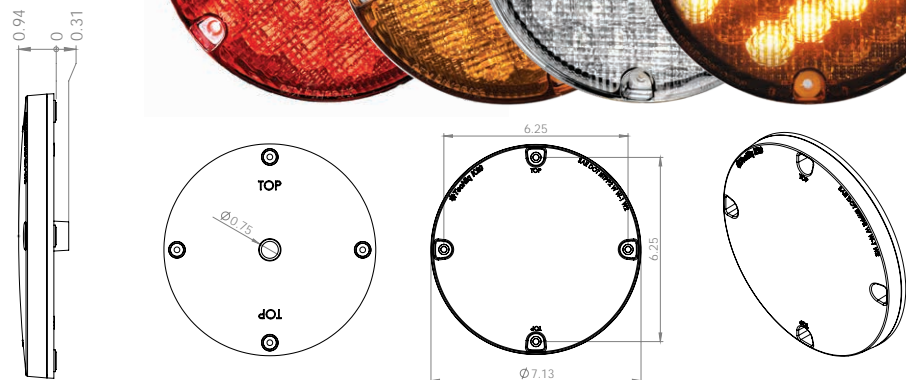
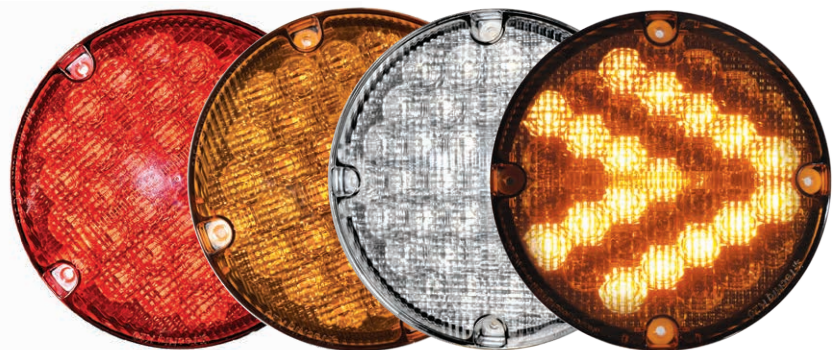

| Part No.   | Part Description (Please see Index, or <a href="http://www.TecNiqInc.com">www.TecNiqInc.com</a> for a complete part list) | Amp Draw                                      | Color | Pack |
|------------|---|---|-------|------|
| K20-WBU0-1 | Steady 7in Round White Backup Lamp  | Hi - ≈0.9A – Brk/Flash<br>Lo - ≈0.014A – Tail |       | 15   |
| K20-AAT0-1 | Steady 7in Round Amber Turn Amber Lens  |   |       | 15   |
| K20-STR0-1 | Steady 7in Round Red STT Red Lens   |   |       | 15   |
| K20-AAS0-1 | Steady 7in Round Amber Flasher Lamp Amber Lens  |   |       | 15   |

Over 80” ID Bars & Stop/Tail/Turn



## T60 – 6” Oval Stop/Tail/Turn Grommet Mount



- Standard 6” oval applications
- Can be purchased for horizontal or vertical mounting positions
- Available in pigtail, standard connectors, or custom connectors for easy install
- **DOT Rated**
- **WIRE COLORS**  
**White** - Ground, **Red** - Stop/Turn, **Black** - Tail

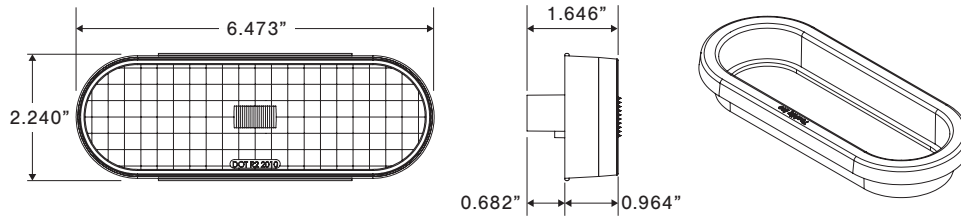
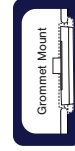

| Part No.   | Part Description (Please see Index, or <a href="http://www.TecNiqInc.com">www.TecNiqInc.com</a> for a complete part list) | Amp Draw    | Color  | Pack |
|------------|---|-------------|--------|------|
| T60-AAVP-1 | 6" Oval Amber Turn Vertical Grommet Mnt Amber Lens Pig Tail   | 0.17A-0.23A | Yellow | 140  |
| T60-RRVP-1 | 6" Oval Red STT Vertical Grommet Mount Red Lens Pig Tail  | 0.17A-0.23A | Red    | 140  |
| T60-ACVP-1 | 6" Oval Amber Turn Vertical Grommet Mnt Clear Lens Pig Tail   | 0.28A-0.36A | Yellow | 140  |
| T60-RCVP-1 | 6" Oval Red STT Vertical Grommet Mount Clear Lens Pig Tail  | 0.10A-0.14A | Red    | 140  |

Over 80" ID Bars & Stop/Tail/Turn



## T61 – 6” Oval Stop/Tail/Turn Surface Mount



- Standard 6” oval applications
- Can be purchased for horizontal or vertical mounting positions
- Available in pigtail, standard connectors, or custom connectors for easy install
- **DOT Rated**
- **WIRE COLORS**  
**White** - Ground, **Red** - Stop/Turn, **Black** - Tail

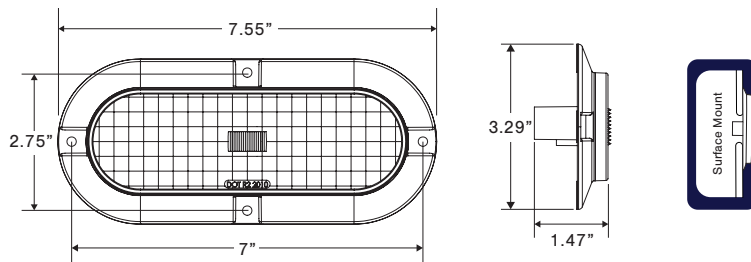

| Part No.   | Part Description (Please see Index, or <a href="http://www.TecNiqInc.com">www.TecNiqInc.com</a> for a complete part list) | Amp Draw    | Color  | Pack |
|------------|---|-------------|--------|------|
| T61-AAVP-1 | 6" Oval Amber Turn Vertical Surface Mount Amber Len Pig Tail  | 0.17A-0.23A | Yellow | 140  |
| T61-RRVP-1 | 6" Oval Red STT Vertical Surface Mount Red Lens Pig Tail  | 0.17A-0.23A | Red    | 140  |
| T61-ACVP-1 | 6" Oval Amber Turn Vertical Surface Mnt Clear Lens Pig Tail   | 0.28A-0.36A | Yellow | 140  |
| T61-RCVP-1 | 6" Oval Red STT Vertical Surface Mount Clear Lens Pig Tail  | 0.10A-0.14A | Red    | 140  |





## T62 – 6” Oval Flange Mount Stop/Tail/Turn

- Standard 6” oval applications
- Can be purchased for horizontal or vertical mounting positions
- Available in pigtail, standard connectors, or custom connectors for easy install

• **DOT Rated**

• **WIRE COLORS**

**White** - Ground, **Red** - Stop/Turn, **Black** - Tail

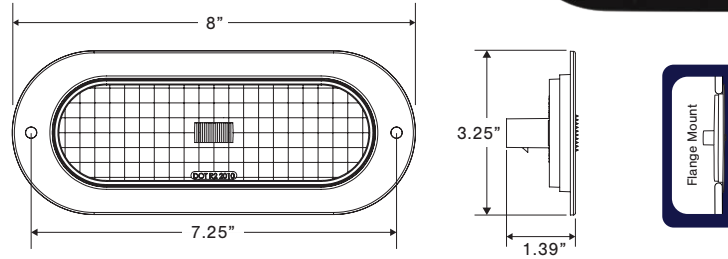

| Part No.   | Part Description (Please see Index, or <a href="http://www.TecNiqInc.com">www.TecNiqInc.com</a> for a complete part list) | Amp Draw    | Color     | Pack |
|------------|---|-------------|-----------|------|
| T62-OS00-1 | SS trim ring for oval tail lamp   |             |           |      |
| T62-AAHA-1 | Amber Flush Mount Horizontal Amber Lens Amp Connector   |             | Amber     |      |
| T62-RRVA-1 | Red Flush Mount Vertical Oval Tail Red Lens Amp Connector   | 0.17A-0.23A | Red       | 120  |
| T62-RCVA-1 | Red Flush Mount Vertical Oval Tail Clear Lens Amp Connector   | 0.10A-0.14A | Red/Clear | 120  |



## T66 – 6” Oval Stop/Tail/Turn

- Fits standard 6” oval applications
- Grommet or surface mount
- Available in pigtail, standard connectors, or custom connectors for easy install

• **DOT Rated**

• **WIRE COLORS**

**White** - Ground, **Red** - Stop/Turn, **Black** - Tail



\* Can be mounted at any angle

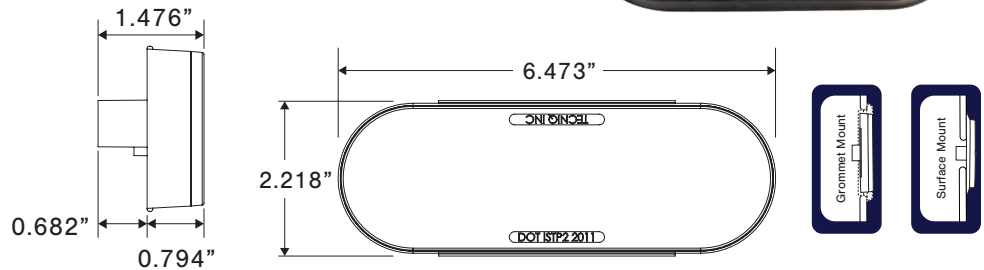

| Part No.   | Part Description (Please see Index, or <a href="http://www.TecNiqInc.com">www.TecNiqInc.com</a> for a complete part list) | Amp Draw    | Color | Pack |
|------------|---|-------------|-------|------|
| T66-AA0P-1 | 6" Oval 6 LED Turn Grommet Mount Amber Lens Pigtail   |             | Amber | 140  |
| T66-AASP-1 | 6" Oval 6 LED Turn Surface Mount Amber Lens Pig-Tail  | 0.17A-0.28A | Amber | 140  |
| T66-RR0P-1 | 6" Oval 6 LED STT Grommet Mount Red Lens Pigtail  |             | Red   | 140  |
| T66-RRSP-1 | 6" Oval 6 LED STT Surface Mount Red Lens Pigtail  | 0.15A-0.20A | Red   | 140  |

Over 80" ID Bars & Stop/Tail/Turn



# T67 – 6” Oval DOT Diffused Light

**NEW PRODUCT**

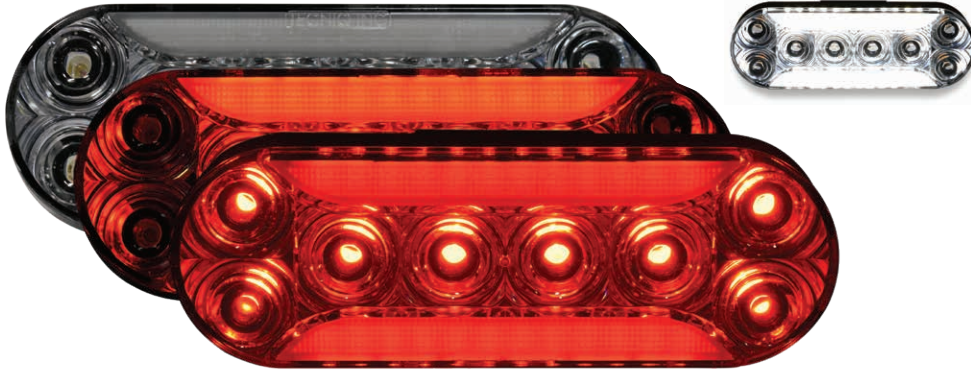

- Fits standard 6” oval applications
- 100% sealed light
- Available in (4) different lens/LED configurations
- Grommet mount
- **Amp** connector
- **DOT Rated**

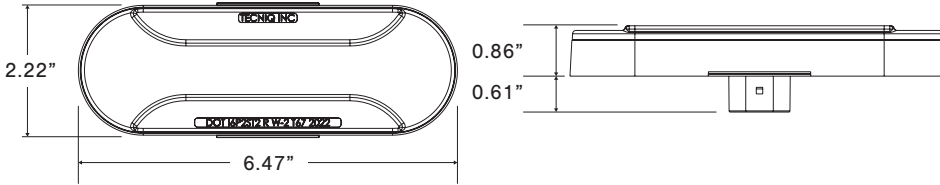

| Part No.   | Part Description (Please see Index, or <a href="http://www.TecNiqInc.com">www.TecNiqInc.com</a> for a complete part list) | Amp Draw      | Color  | Pack |
|------------|---|---------------|--|------|
| T67-RC0P-1 | T67 STT 6" Oval w Pigtail PCB Assembly  |               | <input type="checkbox"/> <input type="radio"/> |      |
| T67-RW0A-1 | 6" Oval Grommet Red Diffuse STTR w Dual Amp   | 0.14A - 0.20A | <input type="checkbox"/> <input type="radio"/> |      |
| T67-RW0P-1 | 6" Oval Grommet Red Diffuse STTR w Pigtails   |               | <input type="checkbox"/> <input type="radio"/> |      |
| T67-WC0A-1 | 6" Oval Grommet Diffuse Reverse w Amp   | 0.49A - 0.66A | <input type="checkbox"/> <input type="radio"/> |      |

Over 80" ID Bars & Stop/Tail/Turn



# T68 – 6” Oval High Visibility Stop/Tail/Turn



- Fits standard 6” oval applications
- Grommet, flange & surface mount
- Available in pigtail, standard connectors, or custom connectors for easy install
- **DOT Rated**



\* Can be mounted at any angle

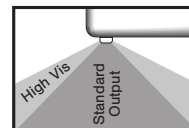

- **WIRE COLORS**  
**White** - Ground, **Red** - Stop/Turn, **Black** - Tail

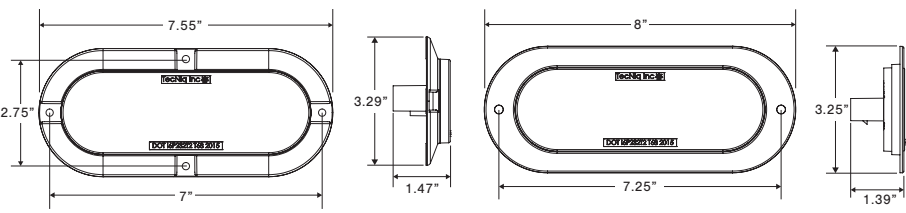
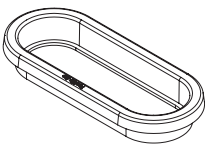

| Part No.    | Part Description (Please see Index, or <a href="http://www.TecNiqInc.com">www.TecNiqInc.com</a> for a complete part list) | Amp Draw    | Color  | Pack |
|-------------|---|-------------|--|------|
| T68-RRF0P-1 | 6" Oval High Visibility Flange Mount STT Pig-Tail   |             | <input type="checkbox"/> <input type="radio"/> | 140  |
| T68-RRG0P-1 | 6" Oval High Visibility Grommet Mount STT Pig-Tail  | 0.12A-0.16A | <input type="checkbox"/> <input type="radio"/> | 140  |
| T68-RRS0P-1 | 6" Oval High Visibility Surface Mount STT Pig-Tail  |             | <input type="checkbox"/> <input type="radio"/> | 140  |



# T70 – 6” Oval High Visibility Stop/Tail/Turn/Reverse

- Fits standard 6” oval applications
- Grommet, flange & surface mount
- Highly efficient amp draw
- Available with pigtail, standard or custom connectors
- **DOT Rated**



\* Can be mounted at any angle



**• WIRE COLORS**

**White** - Ground, **Red** - Stop/Turn, **Black** - Tail

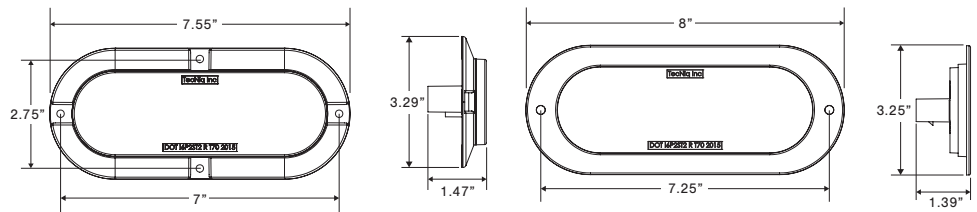
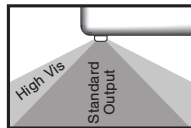

| Part No.   | Part Description (Please see Index, or <a href="http://www.TecNiqInc.com">www.TecNiqInc.com</a> for a complete part list) | Amp Draw      | Color | Pack |
|------------|---|---------------|-------|------|
| T70-RC0P-1 | Oval Grommet Stop Tail Reverse Clear 2 Pigtail Wire   | 0.11A - 0.13A |       | 120  |
| T70-RCFP-1 | Oval Flange Stop Tail Reverse Clear 2 Pigtail Wire  |               |       | 140  |
| T70-RW0P-1 | Oval Grommet Stop Tail Reverse 2 Pigtail Wire   |               |       | 120  |
| T70-RWFP-1 | Oval Flange Stop Tail Reverse 2 Pigtail Wire  |               |       | 140  |



# T71 – 4” Rectangular High Visibility Stop/Tail/Turn

- Smooth surface gives great look
- 100% sealed light
- Grommet mount
- Available in Pigtail, Tri-Pole, and Amp connectors
- **DOT Rated**

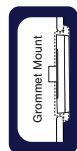
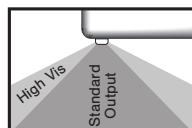

**• WIRE COLORS**

**White** - Ground, **Red/Amber** - High, **Black** - Low/Dim

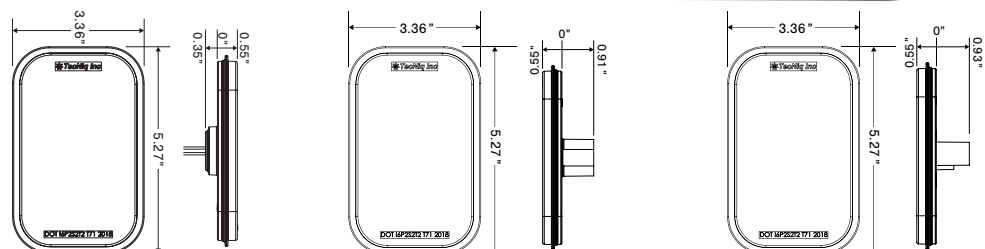

\* Pigtail

\* Tri-Pole

\* Amp

| Part No.   | Part Description (Please see Index, or <a href="http://www.TecNiqInc.com">www.TecNiqInc.com</a> for a complete part list) | Amp Draw    | Color | Pack |
|------------|---|-------------|-------|------|
| T71-AA0P-1 | 4" Rectangular Amber Lens Amber LED AMP Connector W/Pigtails &  | 0.14A-0.18A |       | 24   |
| T71-AC0P-1 | Rectangular 8 LED Turn Dual Intensity Grommet Mount Clear Lens  |             |       | 24   |

Over 80" ID Bars & Stop/Tail/Turn





# T80 – 8” Eight Function Box Tail Light

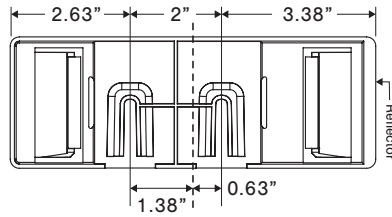
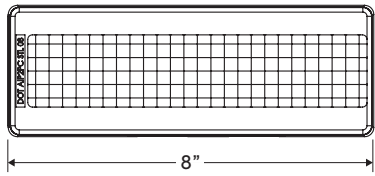
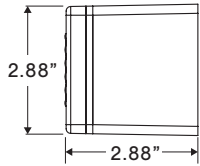
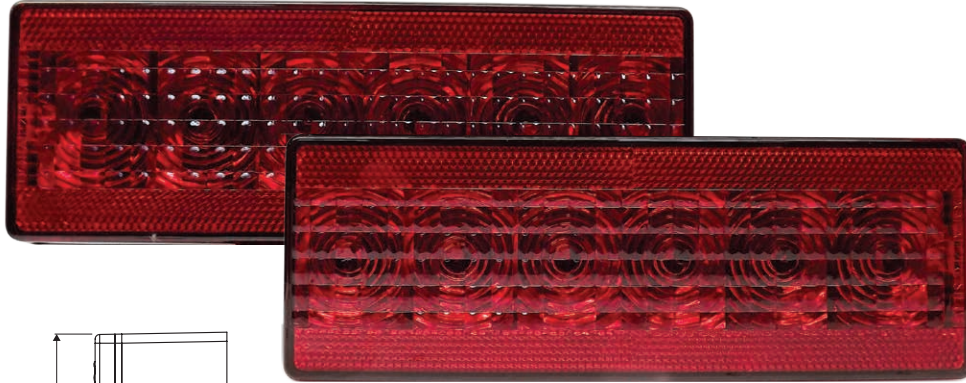

- 100% sealed light
- Available in Pigtail, Standard, or with custom connector
- Fits standard mounting as a direct replacement
- **Functions Include:** Stop/Tail/Turn/Clearance/Side Marker/Side Reflector/Rear Reflector/License Plate (left side)
- **WIRE COLORS**  
**White** - Ground,  
**Brown** - Low/License Plate,  
**Green** (Right) - High,  
**Yellow** (left) - High



| Part No.   | Part Description (Please see Index, or <a href="http://www.TecNiqInc.com">www.TecNiqInc.com</a> for a complete part list) | Amp Draw                 | Color | Pack |
|------------|---|--------------------------|-------|------|
| T80-RRLP-1 | 8 Function 8" Box Tail Light Left Side Pig Tail   | 0.25A-0.35A (brake & LP) | Red   | 32   |
| T80-RRRP-1 | 7 Function 8" Box Tail Light Right Side Pig Tail  | 0.17A-0.24A (brake)      | Red   | 32   |

Over 80" ID Bars & Stop/Tail/Turn



# T81 – 7.5” Contoured, 8 Function Box Tail Light

**NEW PRODUCT**

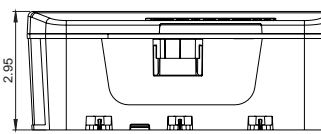
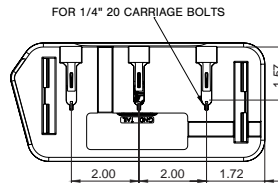
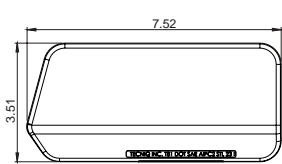
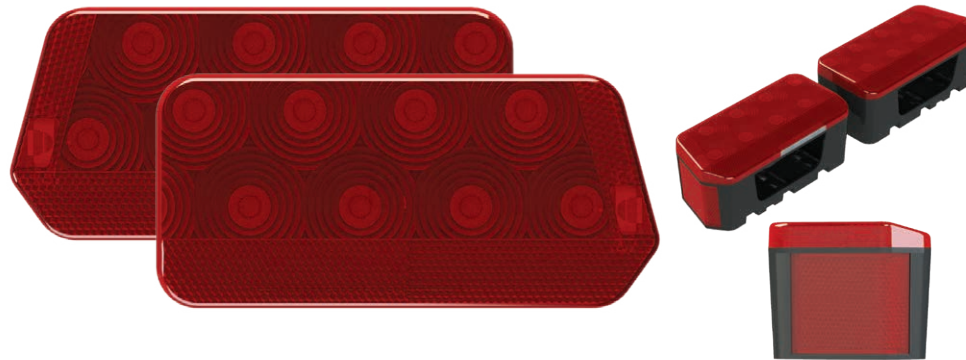

- 100% sealed light
- Available in Pigtail, Standard, or with custom connector
- Fits standard mounting as a direct replacement
- **Functions Include:** Stop/Tail/Turn/Clearance/Side Marker/Side Reflector/Rear Reflector/License Plate (left side)
- **WIRE COLORS**  
**White** - Ground,  
**Brown** - Low/License Plate,  
**Green** (Right) - High,  
**Yellow** (left) - High



| Part No.   | Part Description (Please see Index, or <a href="http://www.TecNiqInc.com">www.TecNiqInc.com</a> for a complete part list) | Amp Draw                     | Color | Pack |
|------------|---|------------------------------|-------|------|
| T81-RRLT-1 | 8 Function Tail Light, Left Side w/ Tripole connector   | Not Available at Publication | Red   | -    |
| T81-RRRT-1 | 7 Function Tail Light, Right Side w/Tripole connector   | Not Available at Publication | Red   | -    |



## T85 – 4” Eight Function Box Tail Light

- 100% sealed light
- Available in Pigtail, Standard, or with custom connector
- Fits standard mounting as a direct replacement
- **Functions Include:** Stop/Tail/ Turn/Clearance/Side Marker/ Side Reflector/Rear Reflector/ License Plate (left side)



\* Underneath of left hand side with license plate light

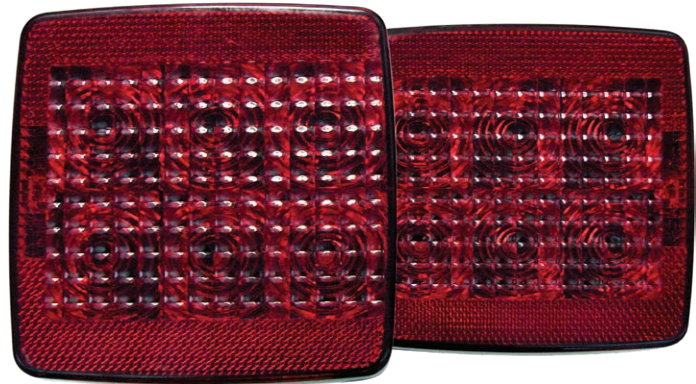

### WIRE COLORS

- White** - Ground,
- Brown** - Low/License Plate,
- Green** (Right) - High,
- Yellow** (left) - High

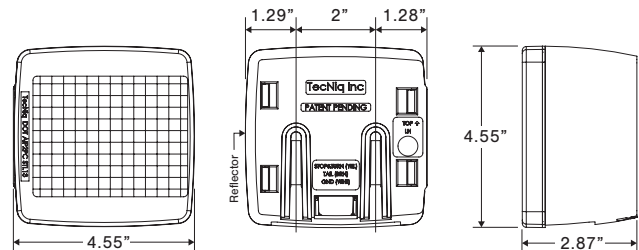

| Part No.   | Part Description (Please see Index, or <a href="http://www.TecNiqInc.com">www.TecNiqInc.com</a> for a complete part list) | Amp Draw                 | Color | Pack |
|------------|---|--------------------------|-------|------|
| T85-RRLP-1 | 8 Function 4" Box Tail Light Left Side Pig Tail   | 0.24A-0.34A (brake & LP) | ● ●   | 32   |
| T85-RRRP-1 | 7 Function 4" Box Tail Light Right Side Pig Tail  | 0.14A-0.24A (brake)      | ● ●   | 32   |



## T86 – 6” Eight Function Box Light

- 100% sealed light
- Available in Pigtail, Standard, or with custom connector
- Fits standard mounting as a direct replacement
- **Functions Include:** Stop/Tail/ Turn/Clearance/Side Marker/ Side Reflector/Rear Reflector/ License Plate (left side)



### WIRE COLORS

- White** - Ground,
- Brown** - Low/License Plate,
- Green** (Right) - High,
- Yellow** (left) - High

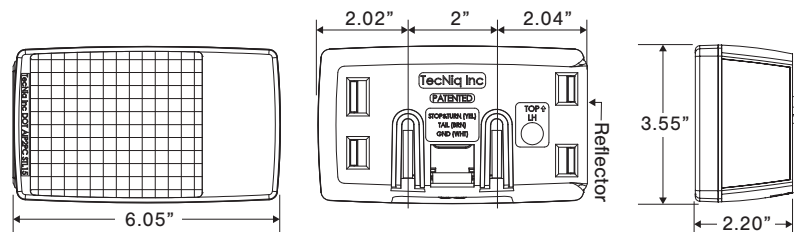

| Part No.    | Part Description (Please see Index, or <a href="http://www.TecNiqInc.com">www.TecNiqInc.com</a> for a complete part list) | Amp Draw                   | Color | Pack |
|-------------|---|----------------------------|-------|------|
| T86-RR2LP-1 | 8 Function 6" Box Slim Line Tail Light Left Side Pig Tail   | 0.23A - 0.32A (brake & LP) | ● ●   | 32   |
| T86-RR2RP-1 | 7 Function 6" Box Slim Line Tail Light Right Side   | 0.9A - 0.15A (brake)       | ● ●   | 32   |

Over 80" ID Bars & Stop/Tail/Turn



# THE EVOLUTION OF TRAILER LIGHTING

# TecLoq

BOX LIGHTING

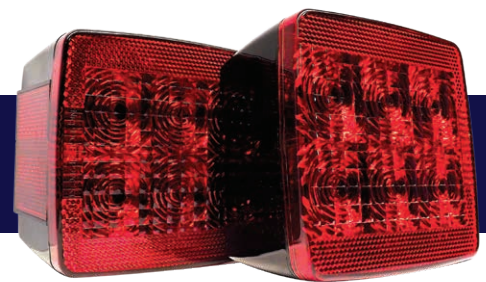

TecNiq is Setting Out to Change the Way Trailer Lighting Works for Manufacturers

TecNiq's **ALL NEW T88 & T89 TecLoq System** is an evolution in the trailer lighting industry. The TecLoq lights feature an all new, Patent Pending, locking interface with a bracket design that locks the box tail light into place with no fasteners necessary.

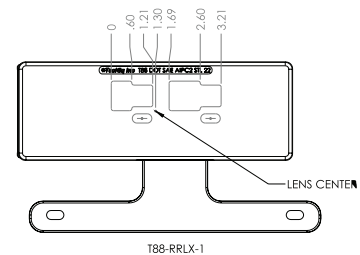

## IMAGINE

Not having to pay for bolts, washers or more, on each install.

## CONSIDER

Cutting labor costs to install Stop, Tail, Turn Lights for each trailer.

## THE SWITCH

TecNiq will work to provide the tools your business needs to get started.

Contact us today to see if you qualify for a **FREE 25 sets** of the TecLoq Box Lighting Products, at [TecLoqinfo@tecniqinc.com](mailto:TecLoqinfo@tecniqinc.com)





# T88 – 8” Eight Function TecLoq Box Lighting System

- Locking bracket system requires no hardware during installation
- Labor costs cut by lack of hardware, and faster installs
- **FREE** bracket design schematics and engineering support available
- **Functions Include:** Stop/Tail/Turn/Clearance/Side Marker/Side Reflector/Rear Reflector/License Plate (left side)

**• WIRE COLORS**

- White** - Ground,
- Brown** - Low/License Plate,
- Green** (Right) - High,
- Yellow** (left) - High

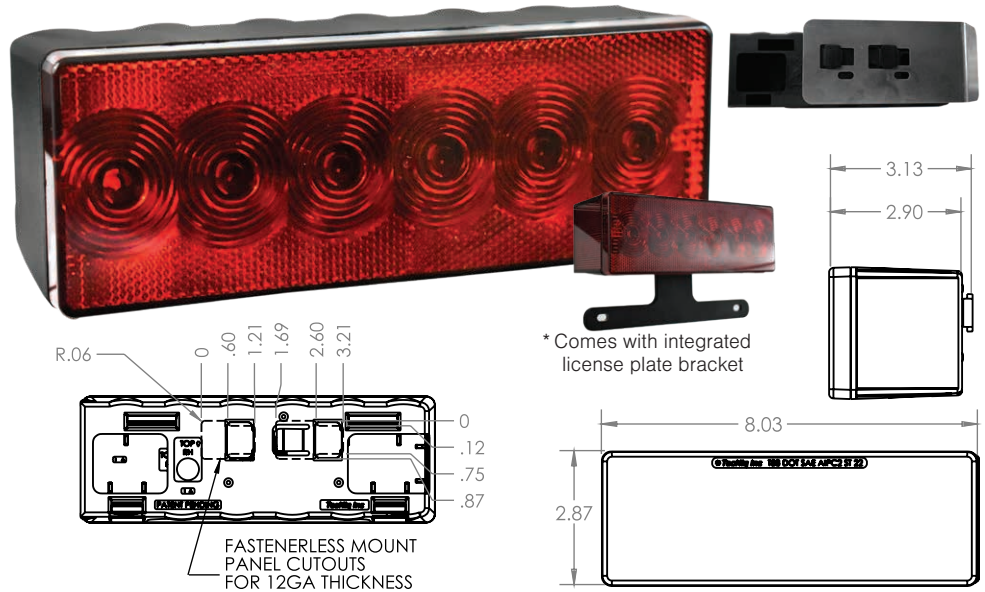

| Part No.   | Part Description (Please see Index, or <a href="http://www.TecNiqInc.com">www.TecNiqInc.com</a> for a complete part list) | Amp Draw       | Color | Pack |
|------------|---|----------------|-------|------|
| T88-RRLT-1 | 8 Function Slim Line Snap Mount Tail Light Left Side  | 0.155A - 0.10A | ● ●   | TBD  |
| T88-RRRT-1 | 7 Function Slim Line Snap Mount Tail Light Right Side   | 0.055A - 0.10A | ● ●   | TBD  |

Over 80" ID Bars & Stop/Tail/Turn



# T89 – 4” Eight Function TecLoq Box Lighting System

- Locking bracket system requires no hardware during installation
- Labor costs cut by lack of hardware, and faster installs
- FREE bracket design schematics and engineering support available
- **Functions Include:** Stop/Tail/Turn/Clearance/Side Marker/Side Reflector/Rear Reflector/License Plate (left side)

**• WIRE COLORS**

- White** - Ground,
- Brown** - Low/License Plate,
- Green** (Right) - High,
- Yellow** (left) - High

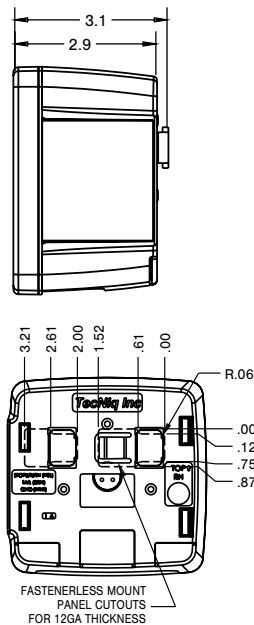

| Part No.   | Part Description (Please see Index, or <a href="http://www.TecNiqInc.com">www.TecNiqInc.com</a> for a complete part list) | Amp Draw                 | Color | Pack |
|------------|---|--------------------------|-------|------|
| T89-RRLP-1 | 8 Function 4" Box Tail Light Snap Mount Left Pigtail  | 0.24A-0.34A (brake & LP) | ● ●   | TBD  |
| T89-RRRP-1 | 7 Function 4" Box Tail Light Snap Mount Right Pigtail   | 0.14A-0.24A (brake)      | ● ●   | TBD  |



# S12 – 2.5” Low Profile Side Marker w/Reflector



- Impact resistant lens
- Standard non-polarized connector
- Energy efficient current draw
- Performance over 100,000 hours
- **DOT Rated**

• **WIRE COLORS**

**White** - Ground, **Red** - Stop/Turn, **Black** - Tail, **Yellow** - Reverse

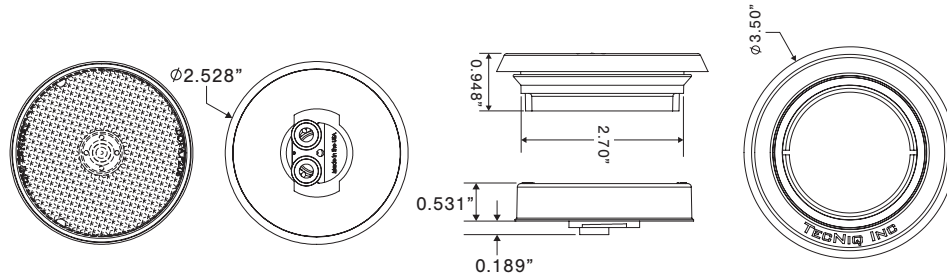

| Part No.   | Part Description (Please see Index, or <a href="http://www.TecNiqInc.com">www.TecNiqInc.com</a> for a complete part list) | Amp Draw    | Color | Pack |
|------------|---|-------------|-------|------|
| S12-AA00-1 | 2 1/2 Inch Round Marker Amber   | 0.05A-0.07A |       | 150  |
| S12-AA40-1 | 2 1/2 Inch Round 4 LED Marker Amber   |             |       | 150  |
| S12-RR00-1 | 2 1/2 Inch Round Marker Red   |             |       | 150  |
| S12-RR40-1 | 2 1/2 Inch Round 4 LED Marker Red   |             |       | 150  |

Clearance & Side Markers



# S14 – PC/P2 Rated Marker Light



- Brilliant illumination in a small size
- Stud-mounted no visible fasteners
- Energy efficient current draw
- Vertical mount position meets P2 specifications, while horizontal mount meets PC specifications

• **WIRE COLORS**

**Black** - Positive, **Stainless Steel Stud** - Ground

\*Stainless steel stud mounted design

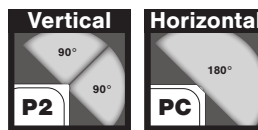
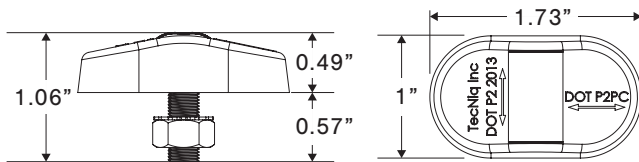

| Part No.   | Part Description (Please see Index, or <a href="http://www.TecNiqInc.com">www.TecNiqInc.com</a> for a complete part list) | Amp Draw    | Color | Pack |
|------------|---|-------------|-------|------|
| S14-ACS0-1 | S14 Amber PCP2 Stud Mount Marker Light Clear Lens Pigtail   | 0.04A-0.07A |       | 100  |
| S14-RCS0-1 | S14 Red PCP2 Stud Mount Marker Light Clear Lens Pigtail   |             |       | 100  |
| S14-RRS0-1 | S14 Red PCP2 Stud Mount Marker Light Red Lens Pigtail   | 0.07A-0.09A |       | 100  |
| S14-RRS1-1 | S14 Red PCP2 Stud Mount Marker Red Lens, 24" Wire   | 0.07A-0.09A |       | 100  |





# S15 – PC Clearance Side Marker Light

- Impact resistant lens
- Standard non-polarized connector
- Energy efficient current draw
- Performance over 100,000 hours
- **DOT Rated**

**• WIRE COLORS**

**White** - Ground, **Red** - Stop/Turn, **Black** - Tail, **Yellow** - Reverse



\* Mounting bases available in chrome or black

\* Mounting grommet also available

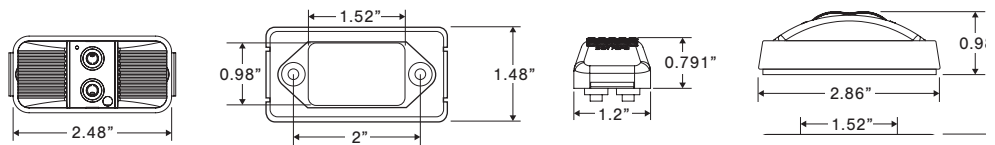

| Part No.   | Part Description (Please see Index, or <a href="http://www.TecNiqInc.com">www.TecNiqInc.com</a> for a complete part list) | Amp Draw    | Color | Pack |
|------------|---|-------------|-------|------|
| S15-AA00-1 | Model S150 Amber PC Sidemarker Amber Lens   | 0.04A-0.07A |       | 120  |
| S15-AC00-1 | Model S150 Amber PC Sidemarker Clear Lens   |             |       | 120  |
| S15-RC00-1 | Model S150 Red PC Sidemarker Clear Lens   |             |       | 120  |
| S15-RR00-1 | Model S150 Red PC Sidemarker Red Lens   |             |       | 120  |



# S17 – PC/P2 Rated Marker Light

- Optional chrome bezel offers premium appearance
- Custom fit gasket available
- Automotive grade lens
- **AVAILABLE IN SMOKED/ TINTED LENS**

**• WIRE COLORS**

**Black** - Positive, **Stainless Steel Stud** - Ground



\* Chrome bezel optional

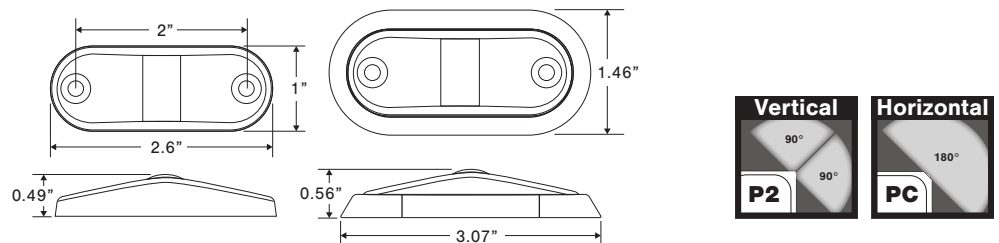

| Part No.   | Part Description (Please see Index, or <a href="http://www.TecNiqInc.com">www.TecNiqInc.com</a> for a complete part list) | Amp Draw    | Color | Pack |
|------------|---|-------------|-------|------|
| S17-AA0P-1 | S17 Amber PCP2 Marker Light Amber Lens Pigtail  | 0.07A-0.09A |       | 100  |
| S17-RR0P-1 | S17 Red PCP2 Marker Light Red Lens Pigtail  |             |       | 100  |
| S17-AC0P-1 | S17 Amber PCP2 Marker Light Clear Lens Pigtail  | 0.04A-0.07A |       | 100  |
| S17-RC0P-1 | S17 Red PCP2 Marker Light Clear Lens Pigtail  |             |       | 100  |

Clearance & Side Markers





## S18 – PC/P2 Rated Marker Light

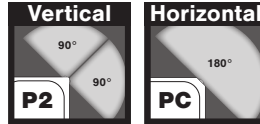

- Optional chrome bezel offers premium appearance
- Custom fit gasket available
- Automotive grade lens
- **DOT Rated**

- **WIRE COLORS**  
White - Ground,  
Red/Amber - Positive

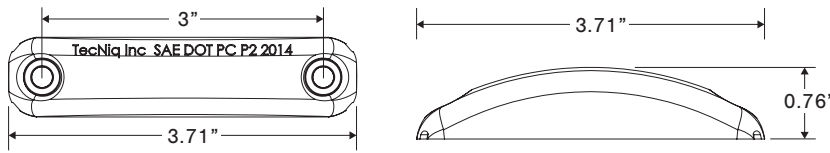

| Part No.   | Part Description (Please see Index, or <a href="http://www.TecNiqInc.com">www.TecNiqInc.com</a> for a complete part list) | Amp Draw    | Color | Pack |
|------------|---|-------------|-------|------|
| S18-AA00-1 | S18 Sidemarker Amber Lens Amber LED   | 0.06A-0.08A |       | 100  |
| S18-AC00-1 | S18 Sidemarker Clear Lens Amber LED   | 0.05A-0.07A |       | 100  |
| S18-RC00-1 | S18 Sidemarker Clear Lens Red LED   |             |       | 100  |
| S18-RR00-1 | S18 Sidemarker Red Lens Red LED   | 0.06A-0.08A |       | 100  |

Clearance & Side Markers



## S19 – PC Rated 1"x4" Side Marker

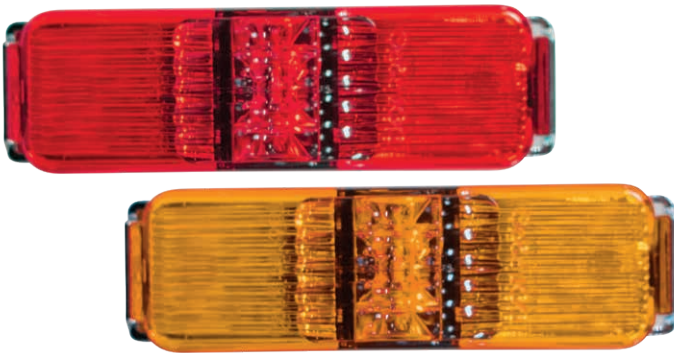

\*Mounting bases required & available in chrome or black

- Surface mounted with **self-grounding** base
- Standard non-polarized male connector
- Performance over 100,000 hours
- **DOT Rated**

- **WIRE COLORS**  
Bi-Directional Positive & Ground

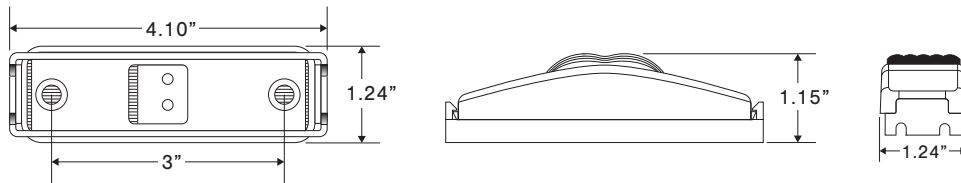

| Part No.   | Part Description (Please see Index, or <a href="http://www.TecNiqInc.com">www.TecNiqInc.com</a> for a complete part list) | Amp Draw    | Color | Pack |
|------------|---|-------------|-------|------|
| S19-AA00-1 | 1"x4" Amber PC Sidemarker Amber Lens  | 0.04A-0.07A |       | 120  |
| S19-AC00-1 | 1"x4" Amber PC Sidemarker Clear Lens  |             |       | 120  |
| S19-RC00-1 | 1"x4" Red PC Sidemarker Clear Lens  |             |       | 120  |
| S19-RR00-1 | 1"x4" Red PC Sidemarker Red Lens  |             |       | 120  |



## S21 – Heavy Duty Oval Marker Light

- Optional chrome bezel offers premium appearance
- Custom fit gasket available
- **AVAILABLE IN SMOKED/ TINTED LENS**
- **DOT Rated**

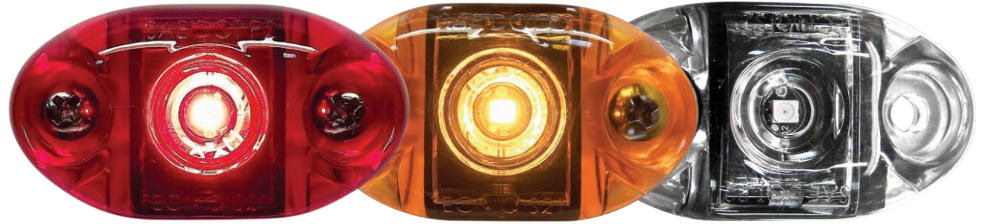

- **WIRE COLORS**  
**White** - Ground,  
**Red/Amber** - Positive



\* Optional stainless steel trim ring

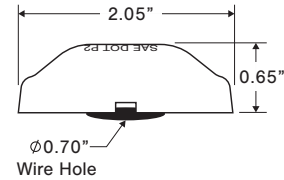
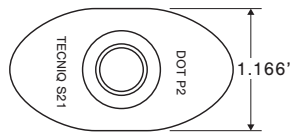
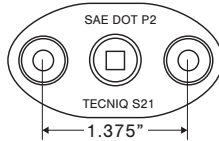

| Part No.   | Part Description (Please see Index, or <a href="http://www.TecNiqInc.com">www.TecNiqInc.com</a> for a complete part list) | Amp Draw      | Color | Pack |
|------------|---|---------------|-------|------|
| S21-AA00-1 | 2" Oval Amber Sidemarkers Amber Lens  | 0.04A - 0.07A |       | 100  |
| S21-AC00-1 | 2" Oval Amber Sidemarkers Clear Lens  |               |       | 100  |
| S21-RC00-1 | 2" Oval Red Sidemarkers Clear Lens  |               |       | 100  |
| S21-RR00-1 | 2" Oval Red Sidemarkers Red Lens  |               |       | 100  |



## S22 – PC Rated Side Marker w/Reflector

- Integrated Retro-reflector
- UV resistant polycarbonate lens
- **DOT Rated**



- **WIRE COLORS**  
**Two-Pole Spade Connector**

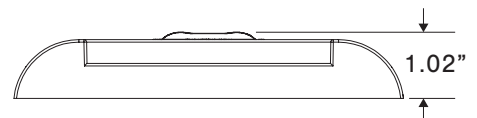
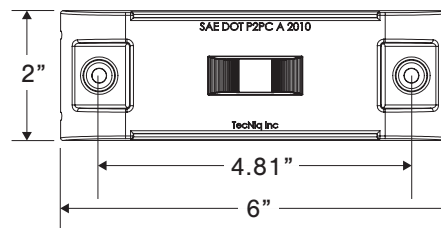

| Part No.   | Part Description (Please see Index, or <a href="http://www.TecNiqInc.com">www.TecNiqInc.com</a> for a complete part list) | Amp Draw    | Color | Pack |
|------------|---|-------------|-------|------|
| S22-AA00-1 | Amber 2" x 6" PC Sidemarkers with reflector   | 0.04A-0.07A |       | 100  |
| S22-AADT-1 | Amber 2" x 6" Dual Intensity PC Sidemarkers with reflector  |             |       | 100  |
| S22-RR00-1 | Red 2" x 6" PC Sidemarkers with reflector   |             |       | 100  |

Clearance & Side Markers



# S24 – 2.5” PC Side Marker w/Reflector



- 100% hermetically sealed
- Standard non-polarized connector
- Performance over 100,000 hours
- **DOT Rated**

• **WIRE COLORS**  
**Bi-Directional** Positive & Ground

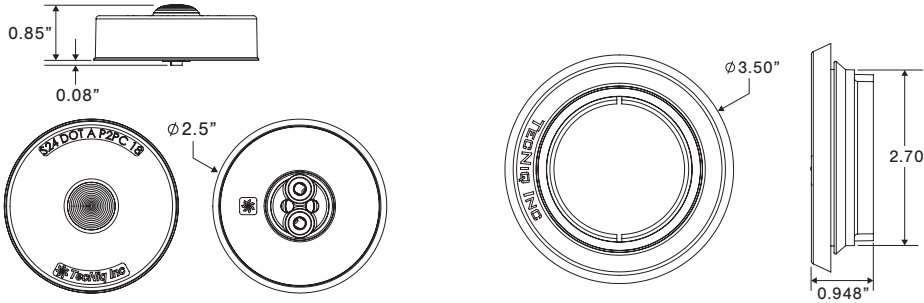

| Part No.   | Part Description (Please see Index, or <a href="http://www.TecNiqInc.com">www.TecNiqInc.com</a> for a complete part list) | Amp Draw    | Color | Pack |
|------------|---|-------------|-------|------|
| S24-AA00-1 | 2.5" Round Amber PC Sidemarker w/Reflector  | 0.07A-0.09A |       | 125  |
| S24-RR00-1 | 2.5" Round Red PC Sidemarker w/Reflector  |             |       | 125  |

Clearance & Side Markers



# S25 – Retro Reflector Side Marker

**NEW PRODUCT**

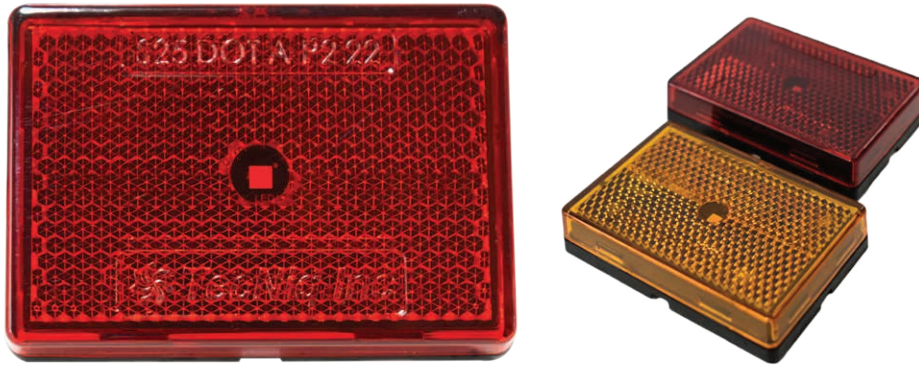

- Rectangular “Retro” reflector
- Connects with Pigtail or Bullet
- Performance over 100,000 hours
- **DOT Rated**

• **WIRE COLORS**  
**White** - Ground, **Black** - Positive

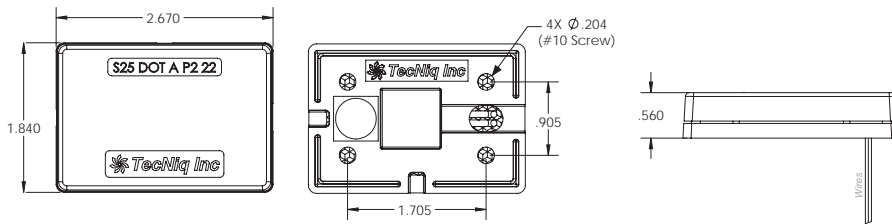

| Part No.    | Part Description (Please see Index, or <a href="http://www.TecNiqInc.com">www.TecNiqInc.com</a> for a complete part list) | Amp Draw | Color | Pack |
|-------------|---|----------|-------|------|
| S25-AA00-1  | 2" x 3" Amber SM w Reflector  | 0.08A    |       | TBD  |
| S25-AAGBS-1 | 2" x 3" Amber SM w Reflector w/ gnd ring and 180 bullet/barrel  |          |       | TBD  |
| S25-RR00-1  | 2" x 3" Red SM w Reflector  |          |       | TBD  |
| S25-RRGBS-1 | 2" x 3" Red SM w Reflector w/ gnd ring and 180 bullet/barrel  |          |       | TBD  |





## S27 – Retro Reflector Side Marker

- PC rated side marker
- 100% sealed light
- Surface mount
- Performance over 100,000 hours
- **DOT Rated**

• **WIRE COLORS**  
2 Pin Amp Connector

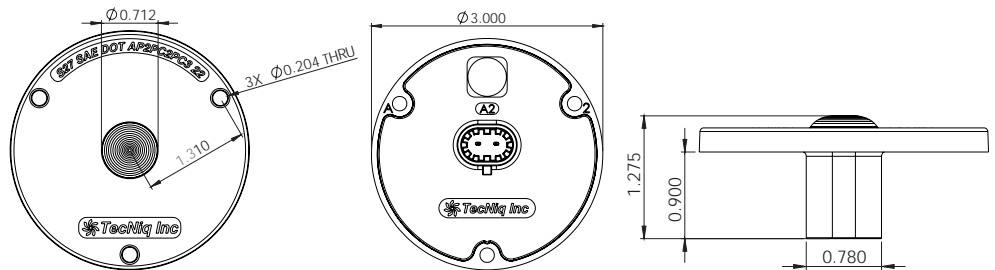

| Part No.   | Part Description (Please see Index, or <a href="http://www.TecNiqInc.com">www.TecNiqInc.com</a> for a complete part list) | Amp Draw | Color | Pack |
|------------|---|----------|-------|------|
| S27-AA0A-1 | 3" Round Amber SM Reflector W 2P Amp  | 0.08A    | Amber | TBD  |
| S27-RR0A-1 | 3" Round Red SM Reflector W 2P Amp  |          | Red   | TBD  |



## S30 – 2" Round, Low-Profile Side Marker

- Grommet mounted industry standard
- Guaranteed circuit board protection
- Performance over 100,000 hours
- **DOT Rated**

• **WIRE COLORS**  
Bi-directional - Positive & Ground



\* Available in clear lens model

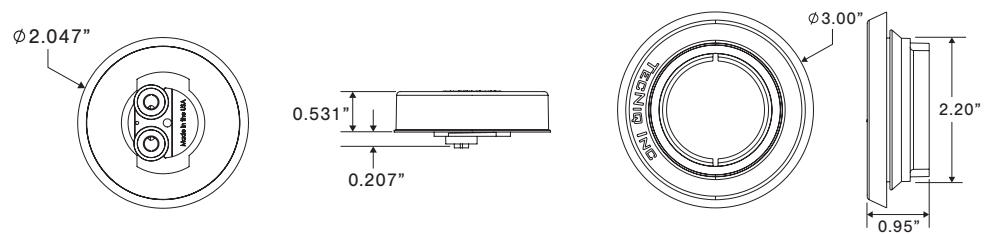

| Part No.   | Part Description (Please see Index, or <a href="http://www.TecNiqInc.com">www.TecNiqInc.com</a> for a complete part list) | Amp Draw      | Color | Pack |
|------------|---|---------------|-------|------|
| S30-AA00-1 | 2" Round Amber Sidemarker Amber Lens  | 0.06A - 0.08A | Amber | 125  |
| S30-AC00-1 | 2" Round Amber Sidemarker Clear Lens  | 0.04A - 0.07A | Amber | 125  |
| S30-RC00-1 | 2" Round Red Sidemarker Clear Lens  |               | Red   | 125  |
| S30-RR00-1 | 2" Round Red Sidemarker Red Lens  | 0.06A - 0.08A | Red   | 125  |

Clearance & Side Markers



# S33 – P2 Rated Miniature Side Marker



- Easily mounts to standard 3/4" hole with no alignment necessary
- UV resistant polycarbonate lens
- Performance over 100,000 hours
- **DOT Rated**

• **WIRE COLORS**  
**White** - Ground, **Black** - Positive

\*S33-0G00-1 for S33 Black Grommets

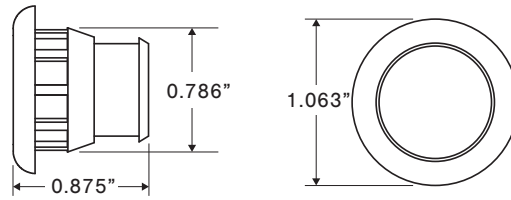

| Part No.   | Part Description (Please see Index, or <a href="http://www.TecNiqInc.com">www.TecNiqInc.com</a> for a complete part list) | Amp Draw    | Color | Pack |
|------------|---|-------------|-------|------|
| S33-AA09-1 | 3/4" Mini P2 Amber Sidemarker Amber Lens, Black Positive 12" Wire   | 0.05A-0.07A |       | 100  |
| S33-RR09-1 | 3/4" Mini P2 Red Sidemarker Red Lens Black Positive 12" Wire  |             |       | 100  |
| S33-AC09-1 | 3/4" Mini P2 Amber Sidemarker Clear Lens Black Positive, 12" Wire   |             |       | 100  |
| S33-RC09-1 | 3/4" Mini P2 Red Sidemarker Clear Lens Black Positive 12" Wire  |             |       | 100  |

Clearance & Side Markers



# S34 – PC/P2 Rated Miniature Side Marker



- Easily mounts to standard 3/4" hole with no alignment necessary
- UV resistant polycarbonate lens
- Performance over 100,000 hours
- **DOT Rated**

• **WIRE COLORS**  
**White** - Ground, **Black** - Positive

\*S33-0G00-1 for S34 Black Grommets

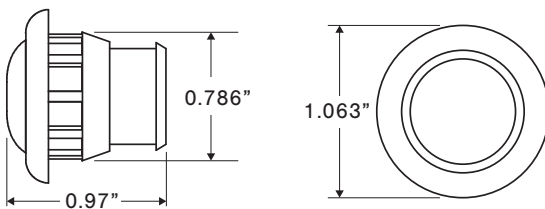

| Part No.   | Part Description (Please see Index, or <a href="http://www.TecNiqInc.com">www.TecNiqInc.com</a> for a complete part list) | Amp Draw | Color | Pack |
|------------|---|----------|-------|------|
| S34-3C00-1 | S34 RGB Light W/Pigtails 7.5" Wire  | Varies   |       | 25   |
| S34-AA09-1 | Amber Mini PC Sidemarker Amber Lens Black Positive 8.5" Wire  |          |       | 25   |
| S34-RR09-1 | Red Mini PC Sidemarker Red Lens 8.5" wire black positive  |          |       | 25   |
| S34-RC09-1 | Red Mini PC Sidemarker Clear Lens Black Positive 12" wire   |          |       | 25   |



## S36 – P2/PC Rated Side Markers

- Horizontal surface mount design for easy installs
- UV resistant polycarbonate lens
- Impact resistant lens
- **DOT Rated**
- **WIRE COLORS**  
Two-Pole Spade Connector

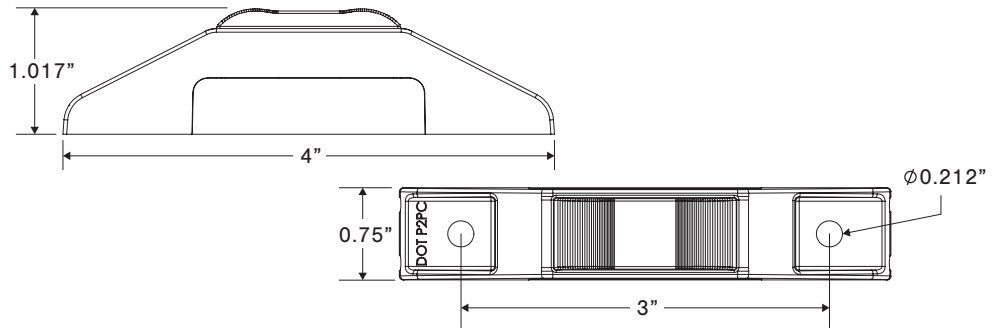

| Part No.   | Part Description (Please see Index, or <a href="http://www.TecNiqInc.com">www.TecNiqInc.com</a> for a complete part list) | Amp Draw    | Color | Pack |
|------------|---|-------------|-------|------|
| S36-AA20-1 | S36 Amber PC Sidemarker Amber Lens  | 0.05A-0.07A |       | 100  |
| S36-RR20-1 | S36 Red PC Sidemarker Red Lens  |             |       | 100  |
| S36-AC20-1 | S36 Amber PC Sidemarker Clear Lens  |             |       | 100  |
| S36-RC20-1 | S36 Red PC Sidemarker Clear Lens  |             |       | 100  |



## S37 – PC/P2 Rated Miniature Side Marker

- Mini 3/4" grommet mount marker light allows for installation in tight spaces
- Guaranteed circuit board protection
- **DOT Rated**
- **WIRE COLORS**  
White/Color - Ground,  
Black - Positive



\*S33-0G00-1 for S33 Black Grommets

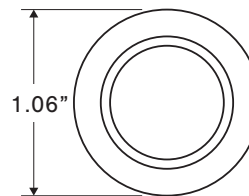
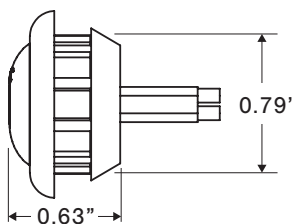

| Part No.   | Part Description (Please see Index, or <a href="http://www.TecNiqInc.com">www.TecNiqInc.com</a> for a complete part list) | Amp Draw      | Color | Pack |
|------------|---|---------------|-------|------|
| S37-AA09-1 | Amber 3/4 PC Sidemarker Amber Lens 5" Wire White GND  | 0.07A - 0.09A |       | 25   |
| S37-RR09-1 | Red 3/4 PC Sidemarker Red Lens 5" Wire White GND  |               |       | 25   |
| S37-AC09-1 | Amber 3/4 PC Sidemarker Clear Lens 5" Wire  | 0.03A - 0.06A |       | 25   |
| S37-RC09-1 | Red 3/4 PC Sidemarker Clear Lens 5" Wire  | 0.06A - 0.08A |       | 25   |

Clearance & Side Markers





## S38 – Surface Mounted PC Rated Side Marker



\* Can be purchased with available gasket

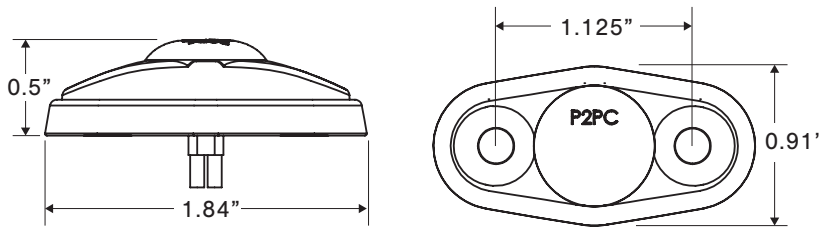

- Easily surface mounts with (2) screws
- Available for purchase with gasket
- Performance over 100,000 hours
- **DOT Rated**

• **WIRE COLORS**  
**White** - Ground, **Black** - Positive



| Part No.   | Part Description (Please see Index, or <a href="http://www.TecNiqInc.com">www.TecNiqInc.com</a> for a complete part list) | Amp Draw      | Color | Pack |
|------------|---|---------------|-------|------|
| S38-AA09-1 | Amber Mini Surface PC Sidemarker Amber Lens 5" wire   | 0.07A - 0.09  |       | 25   |
| S38-RR09-1 | Red Mini Surface PC Sidemarker Red Lens 5" wire   | 0.07A - 0.09  |       | 25   |
| S38-AC09-1 | Amber Mini Surface PC Sidemarker Clear Lens 5" wire   | 0.03A - 0.06A |       | 25   |
| S38-RC09-1 | Red Mini Surface PC Sidemarker Clear Lens 5" wire   | 0.06A - 0.08A |       | 25   |

Clearance & Side Markers



## S39 – Adhesive Mounted PC Rated Side Marker

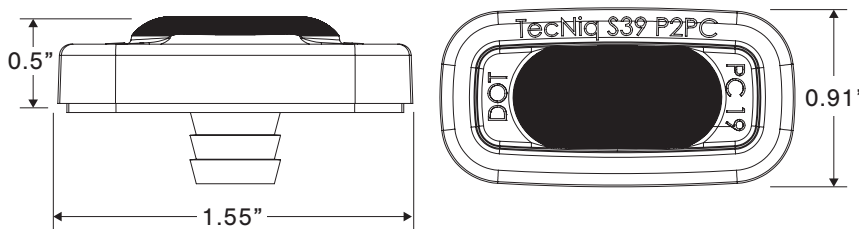

- Adhesive back
- UV resistant polycarbonate lens
- Impact resistant lens
- Guaranteed circuit board protection
- Performance over 50,000 hours
- **DOT Rated**

• **WIRE COLORS**  
**Black** - Ground, **White** - Positive



| Part No.   | Part Description (Please see Index, or <a href="http://www.TecNiqInc.com">www.TecNiqInc.com</a> for a complete part list) | Amp Draw    | Color | Pack |
|------------|---|-------------|-------|------|
| S39-AA00-1 | S39 Amber Sidemarker Amber Len  | 0.07A-0.09A |       | 100  |
| S39-RR00-1 | S39 Red Sidemarker Red Lens   | 0.07A-0.09A |       | 100  |



# S90 – Heavy Duty Miniature Bi-Color Fender Light

- Submersible fender light
- Low profile, symmetrical design allows for use on either side
- **AVAILABLE IN SMOKED/ TINTED LENS**
- **DOT Rated**
- **WIRE COLORS**  
**White** - Ground, **Red** - Positive  
**Black** - Low (dual intensity)



\*Optional stainless steel trim cap



\* Pictured here with optional black or chrome wire guides

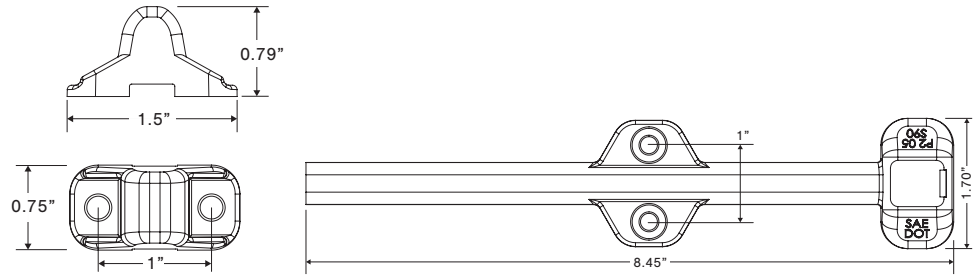

| Part No.   | Part Description (Please see Index, or <a href="http://www.TecNiqInc.com">www.TecNiqInc.com</a> for a complete part list) | Amp Draw    | Color | Pack |
|------------|---|-------------|-------|------|
| S90-0000-1 | Fender Sidemarket Light   | 0.04A-0.07A |       | 150  |
| S90-0BS0-1 | Fender Sidemarket Light Wire Guide Black 4 Screw Full length  |             |       | 150  |
| S90-0CS0-1 | Fender Sidemarket Light Wire Gu Chrome 4 Screw Full Length  |             |       | 150  |
| S90-0SS0-1 | Fender Sidemarket Light SS Stamping   |             |       | 150  |



# S91 – Heavy Duty Bi-Color Fender Light

- Features low amp draw
- UV resistant polycarbonate lens
- Performance over 100,000 hours
- **DOT Rated**
- **WIRE COLORS**  
**White** - Ground, **Black** - Positive



\* Pictured here optional 7.5" black wire guides available

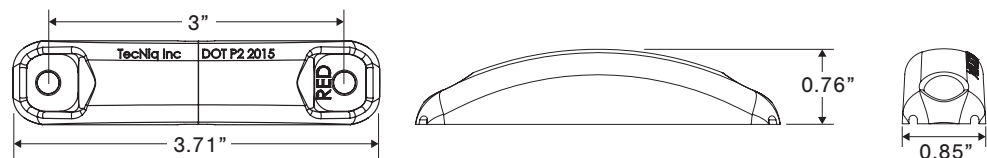

| Part No.   | Part Description (Please see Index, or <a href="http://www.TecNiqInc.com">www.TecNiqInc.com</a> for a complete part list) | Amp Draw    | Color | Pack |
|------------|---|-------------|-------|------|
| S91-AR00-1 | Fender Light Amber Red Lens Pigtail   | 0.06A-0.07A |       | 100  |
| S91-ARC0-1 | Fender Light Clear Lens Pigtail   |             |       | 100  |

Clearance & Side Markers



# T90 – High Efficiency California Mid-Turn

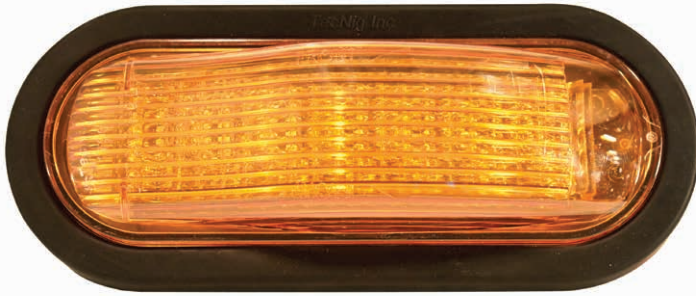

\* Now available with smoked or clear lens options

- Guaranteed circuit boards
- UV resistant, polycarbonate lens
- Performance over 100,000 hours
- **AVAILABLE IN SMOKED/ TINTED LENS**
- **DOT Rated**

- **WIRE COLORS**  
**White** - Ground, **Black** - Low, **Red** - High

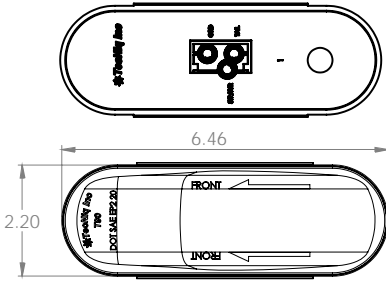

\* Grommet mount dimensions only please see website for other versions

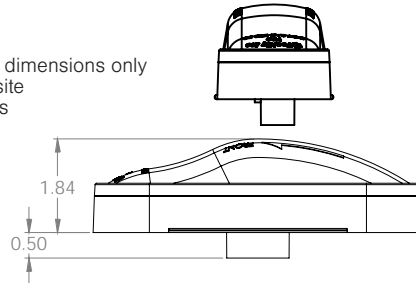

| Part No.   | Part Description (Please see Index, or <a href="http://www.TecNiqInc.com">www.TecNiqInc.com</a> for a complete part list) | Amp Draw         | Color | Pack |
|------------|---|------------------|-------|------|
| T90-AAFP-1 | Midturn Amber Lens Flange Mount Pigtail   |                  |       | 112  |
| T90-AAGP-1 | Midturn Amber Lens Grommet Mount Pigtail  | Hi - 0.25A-0.34A |       | 80   |
| T90-AASP-1 | Midturn Amber Lens Surface Mount Pigtail  | Lo - 0.04A-0.05A |       | 80   |
| T90-ACGP-1 | Midturn Clear Lens Grommet Mount Pigtail  |                  |       | 80   |

Clearance & Side Markers - Reverse Lamps



# T41 – High Brightness Reverse Lamp

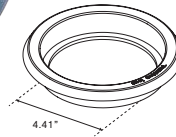
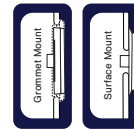

- Available in Pigtail, Standard, or Custom connectors
- Fits all industry standard 4" applications
- Mounts with grommets, flange, or anti-theft, stainless steel trim ring
- **DOT Rated**

- **WIRE COLORS**  
**White** - Ground, **Black** - Positive

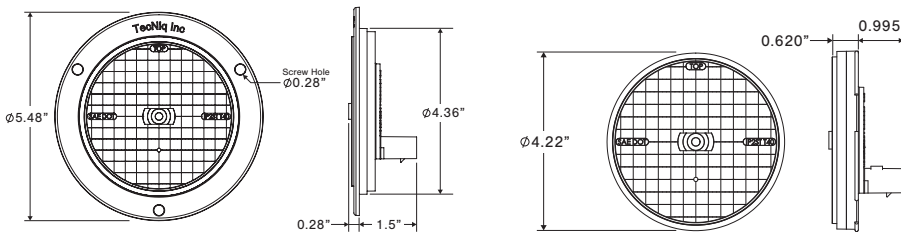

| Part No.   | Part Description (Please see Index, or <a href="http://www.TecNiqInc.com">www.TecNiqInc.com</a> for a complete part list) | Amp Draw    | Color   | Pack |
|------------|---|-------------|---|------|
| T41-WCOP-1 | 4" Round 2x Reverse Lamp Grommet w/Pig Tail   |             | <input type="checkbox"/> <input type="checkbox"/> | 100  |
| T41-WCFP-1 | 4" Round Reverse Lamp Clear Lens Flange Mount Pigtail   | 0.26A-0.34A | <input type="checkbox"/> <input type="checkbox"/> | 100  |





# T61/T62 – 6” Oval High Brightness Reverse Lamp

- Flange mounted 6” oval fits all industry standard applications
- UV resistant, polycarbonate lens
- Performance over 100,000 hours
- **DOT Rated**

- **WIRE COLORS**  
White - Ground, Black - Positive

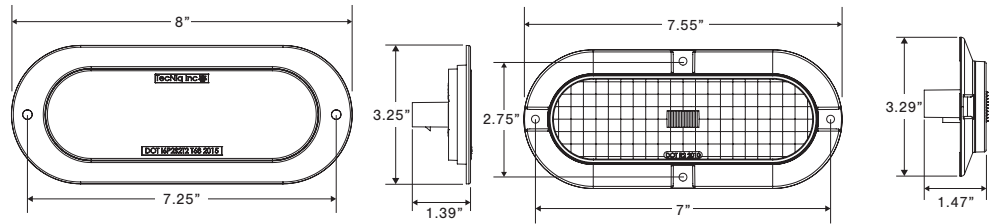

| Part No.   | Part Description (Please see Index, or <a href="http://www.TecNiqInc.com">www.TecNiqInc.com</a> for a complete part list) | Amp Draw    | Color  | Pack |
|------------|---|-------------|--|------|
| T61-WCVP-1 | 6" Oval Vertical Surface Mount Reverse Light Pigtail  | 0.21A-0.27A | <input type="checkbox"/> <input type="radio"/> | 140  |
| T62-W0VA-1 | Oval Tail Reverse Lamp Flush Vertical Mount   | 0.31A-0.39A | <input type="checkbox"/> <input type="radio"/> | 120  |

Reverse Lamps



# T66 – High Brightness Reverse Lamp

- Available in Pigtail, Standard, or Custom connectors
- Fits all industry standard 6” applications
- Can be mounted horizontal, vertical, or at any angle
- **DOT Rated**

- **WIRE COLORS**  
White - Ground, Black - Positive

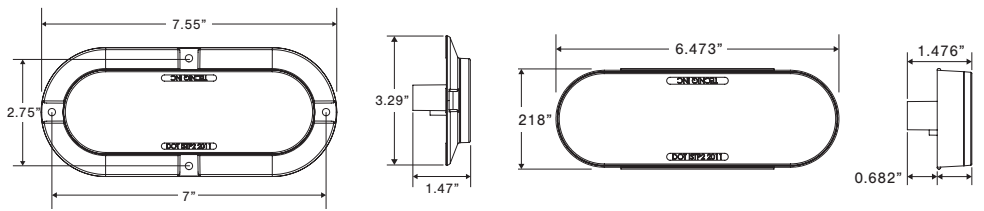

| Part No.   | Part Description (Please see Index, or <a href="http://www.TecNiqInc.com">www.TecNiqInc.com</a> for a complete part list) | Amp Draw    | Color  | Pack |
|------------|---|-------------|--|------|
| T66-WCRP-1 | 6" Oval Reverse 6 LED White Grommet Mount Clear Lens PigTail  | 0.21A-0.27A | <input type="checkbox"/> <input type="radio"/> | 140  |
| T66-WCSP-1 | 6" Oval 6 LED White Reverse Surface Mount Pig-Tail  |             | <input type="checkbox"/> <input type="radio"/> | 140  |
| T66-WCOT-1 | 6" Oval 6 LED White Grommet Mount Clear Lens 3 Pole   |             | <input type="checkbox"/> <input type="radio"/> | 140  |
| T66-WCSA-1 | 6" Oval 6 LED White Reverse Surface Mount Clear Lens Amp Connector  |             | <input type="checkbox"/> <input type="radio"/> | 140  |



# T68 – Hi-Visibility Reverse Lamp

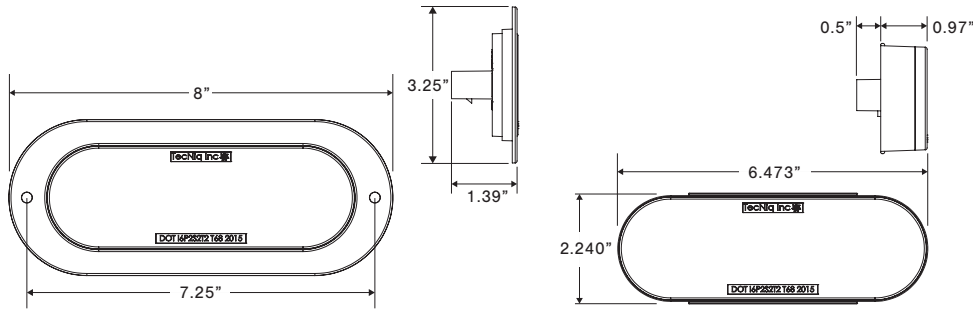

- Extremely bright and durable
- Available in Pigtail, Standard, or Custom connectors
- Fits all industry standard 6" applications
- **DOT Rated**
- **WIRE COLORS**  
White - Ground, Black - Positive



| Part No.    | Part Description (Please see Index, or <a href="http://www.TecNiqInc.com">www.TecNiqInc.com</a> for a complete part list) | Amp Draw      | Color  | Pack |
|-------------|---|---------------|--|------|
| T68-WCF0A-1 | 6" Oval High Vis Reverse Clear Lens Flange Mount Amp Connector  | 0.25A - 0.35A | <input type="checkbox"/> <input type="radio"/> | 120  |
| T68-WCG0A-1 | 6" Oval High Vis Reverse Clear Lens Grommet Mount Amp Connector   |               | <input type="checkbox"/> <input type="radio"/> | 120  |
| T68-WTF0A-1 | 6" Oval High Vis Reverse Tinted Lens Flange Mount   |               | <input type="checkbox"/> <input type="radio"/> | 120  |
| T68-WTG0A-1 | 6" Oval High Vis Reverse Tinted Lens Grommet Mount  |               | <input type="checkbox"/> <input type="radio"/> | 120  |

Reverse Lamps - License Plate Lamps & Brackets



# L10 – DOT Rated License Lamp



- Ideal for surface mount license plates
- Easily mounts using (2) screws - vertically or horizontally
- Available in black or chrome finish
- **SAE and DOT Rated**

- **WIRE COLORS**  
Bi-directional Positive and Ground

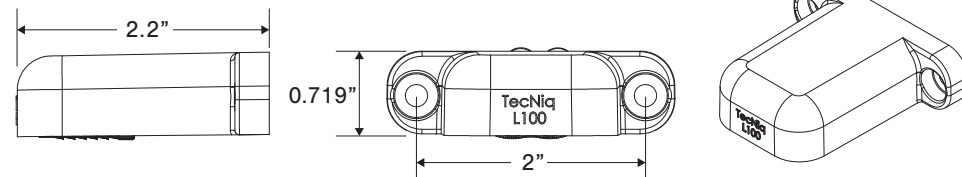

| Part No.   | Part Description (Please see Index, or <a href="http://www.TecNiqInc.com">www.TecNiqInc.com</a> for a complete part list) | Amp Draw    | Color  | Pack |
|------------|---|-------------|--|------|
| L10-WB00-1 | Black Base License Lamp Vertical Plane Mount  | 0.06A-0.11A | <input type="checkbox"/> <input type="radio"/> | 10   |
| L10-WB9B-1 | Black Base License Lamp Vertical Plane Mount w/.180 Bullet  |             | <input type="checkbox"/> <input type="radio"/> | 10   |
| L10-WC00-1 | Chrome Base License Lamp Vertical Plane Mount   |             | <input type="checkbox"/> <input type="radio"/> | 10   |
| L10-WC9B-1 | Chrome Base License Lamp Vertical Plane Mount w/.180 bullet   |             | <input type="checkbox"/> <input type="radio"/> | 10   |



# L11 – DOT Rated License Lamp

- For recess mounted license plates
- Impact resistant lens
- Easily mounts using (2) screws - vertically or horizontally
- Available in black or chrome finish
- **SAE and DOT Rated**



- **WIRE COLORS**  
**Bi-directional Positive and Ground**

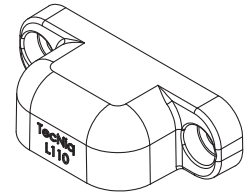
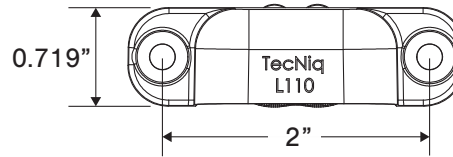
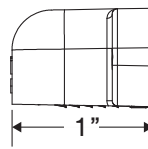

| Part No.   | Part Description (Please see Index, or <a href="http://www.TecNiqInc.com">www.TecNiqInc.com</a> for a complete part list) | Amp Draw    | Color  | Pack |
|------------|---|-------------|--|------|
| L11-WB00-1 | Black Base License Lamp Vertical Plane Mount  | 0.06A-0.11A | <input type="checkbox"/> <input type="radio"/> | 10   |
| L11-WB0T-1 | Black Base License Lamp Vertical Plane Mount w/.15  |             | <input type="checkbox"/> <input type="radio"/> | 10   |
| L11-WC00-1 | Chrome Base License Lamp Vertical Plane Mount   |             | <input type="checkbox"/> <input type="radio"/> | 10   |
| L11-WC9B-1 | Chrome Base License Lamp V-Plane Mount w/.180" Bullets  |             | <input type="checkbox"/> <input type="radio"/> | 10   |



# L12 – DOT Rated License Lamp

- Impact resistant lens
- Easily mounts using (2) screws - vertically or horizontally
- Available in black or chrome finish
- TPE gasket available
- **SAE and DOT Rated**



- **WIRE COLORS**  
**Bi-directional Positive and Ground**



\* Also available in black

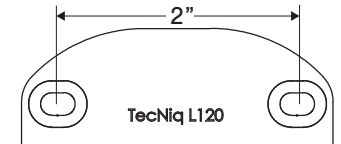
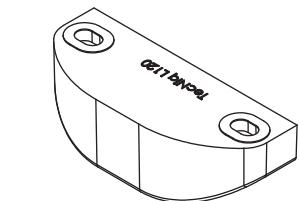
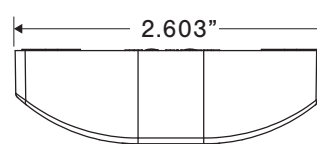
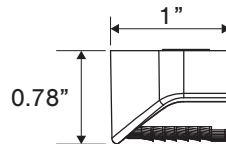

| Part No.   | Part Description (Please see Index, or <a href="http://www.TecNiqInc.com">www.TecNiqInc.com</a> for a complete part list) | Amp Draw    | Color  | Pack |
|------------|---|-------------|--|------|
| L12-WB00-1 | Black Base License Lamp Vertical Plane Mount  | 0.06A-0.11A | <input type="checkbox"/> <input type="radio"/> | 10   |
| L12-WB5B-1 | Black Base License Lamp Vertical Plane Mount w/.180" Bullets  |             | <input type="checkbox"/> <input type="radio"/> | 10   |
| L12-WC00-1 | Chrome Base License Lamp Vertical Plane Mount   |             | <input type="checkbox"/> <input type="radio"/> | 10   |





# L34 – DOT Rated License Lamp



\* Plastic Mounting Bracket

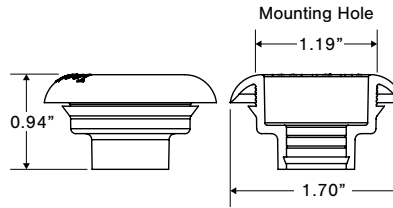
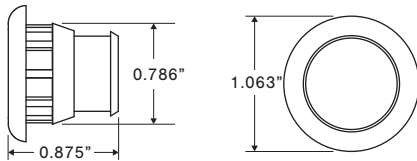

- Impact resistant lens
- Easily mounts into standard 3/4" hole - also available with larger grommet or bracket style (1.125")
- **SAE and DOT Rated**
- **WIRE COLORS**  
**White** - Ground, **Black** - Positive



License Plate Lamps & Brackets

| Part No.   | Part Description (Please see Index, or <a href="http://www.TecNiqInc.com">www.TecNiqInc.com</a> for a complete part list) | Amp Draw   | Color  | Pack |
|------------|---|------------|--|------|
| L34-0G00-1 | L34 Large Diameter Grommet  |            | <input type="checkbox"/> <input type="radio"/> | 10   |
| L34-WB9B-1 | License Lamp Black Bracket w/ .180 Bullets  |            | <input type="checkbox"/> <input type="radio"/> | 10   |
| L34-WC9B-1 | License Lamp Large Grommet w/ .180 Bullets  | 0.07A-0.9A | <input type="checkbox"/> <input type="radio"/> | 10   |
| L34-WG9B-1 | License Lamp Standard Grommet w/ .180 Bullets   |            | <input type="checkbox"/> <input type="radio"/> | 10   |



# L31 & L90 – Full Back License Plate Bracket with or without Light

\* L31 w/ Light



\* L90 w/o Light

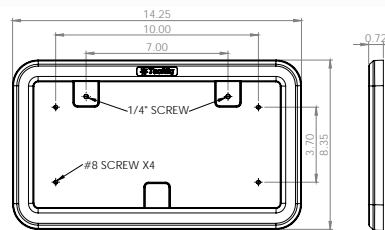
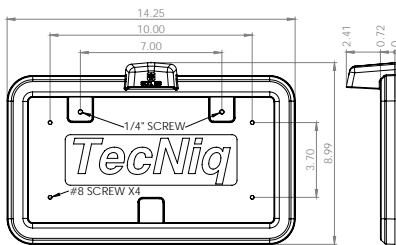

- Polypropylene frame w/ (1) LED
- Comes with (2) 1/4" screws to attach license plate
- Provides single source for bracket and light
- **DOT Rated**
- **WIRE COLORS**  
**Bi-directional Positive and Ground**



| Part No.   | Part Description (Please see Index, or <a href="http://www.TecNiqInc.com">www.TecNiqInc.com</a> for a complete part list) | Amp Draw      | Color  | Pack |
|------------|---|---------------|--|------|
| L31-WB00-1 | License Plate Frame with Light  |               | <input type="checkbox"/> <input type="radio"/> | 10   |
| L31-WB10-1 | License Plate Frame with Light, 15" Wire  | 0.06A - 0.11A | <input type="checkbox"/> <input type="radio"/> | 10   |
| L90-0B00-1 | License plate Full Back No Lamp Black   |               | <input type="checkbox"/> <input type="radio"/> | 10   |
| L90-0G00-1 | License plate frame grey no light   |               | <input type="checkbox"/> <input type="radio"/> | 10   |



# L95 – License Plate Bracket (No Light)

- Black polypropylene license plate bracket
- Available as a direct replacement for broken or missing brackets on most trailers



\* Elevated bracket also available, pictured here

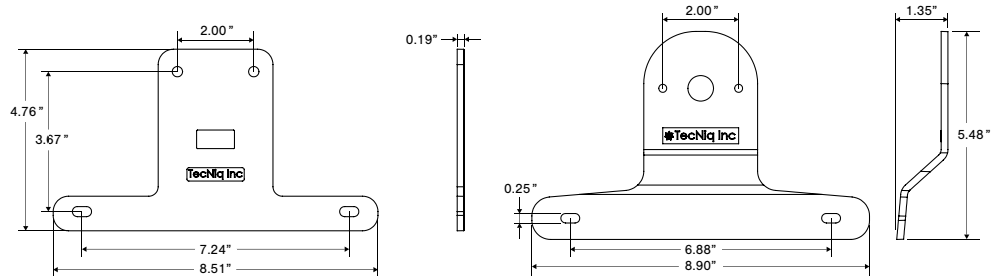

| Part No.   | Part Description (Please see Index, or <a href="http://www.TecNiqInc.com">www.TecNiqInc.com</a> for a complete part list) | Amp Draw | Color | Pack |
|------------|---|----------|-------|------|
| L95-0B00-1 | License Plate Bracket Black Tecniq  |          |       | 10   |
| L95-1B00-1 | Elevated License Plate Bracket Black  |          |       | 10   |



# T24 – Traffic Advisor

**NEW PRODUCT**

- Reliable over 100,000 hours
- LEDs turn off sequentially from one side to the other

**• WIRE COLORS**

- White** – Ground,
- Amber** – High/Turn,
- Black** – Low/Dim

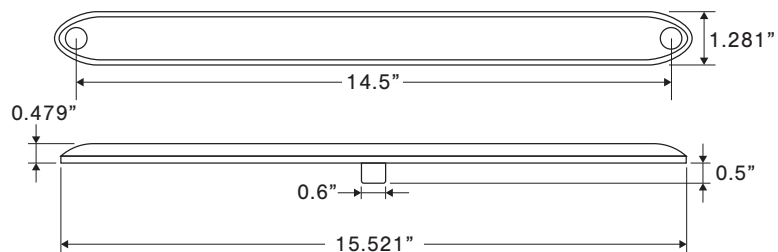

| Part No. | Part Description (Please see Index, or <a href="http://www.TecNiqInc.com">www.TecNiqInc.com</a> for a complete part list) | Amp Draw | Color | Pack |
|----------|---|----------|-------|------|
|----------|---|----------|-------|------|

MORE INFO COMING SOON

License Plate Lamps & Brackets - Strobes & Flashers



# T46 – 4" Round Strobe/Flasher

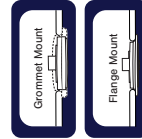

- Class 1 & Class 2 certified
- Fits all industry standard 4" round applications
- Grommet or Flange mount, and available in Pigtail, Standard, or with Custom connectors

**• WIRE COLORS**

**Black** - Ground, **White** - Positive

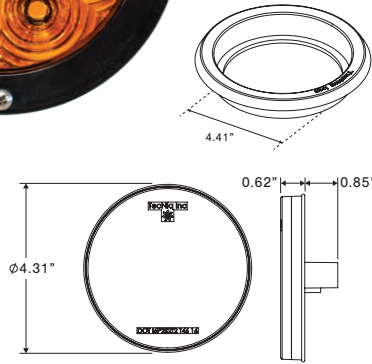
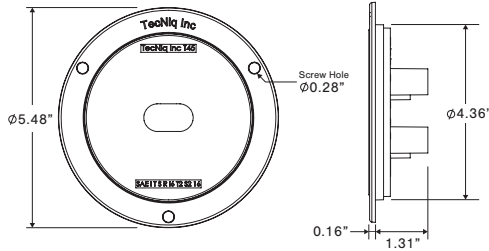

Strobes & Flashers

| Part No.    | Part Description (Please see Index, or <a href="http://www.TecNiqInc.com">www.TecNiqInc.com</a> for a complete part list) | Amp Draw                           | Color | Pack |
|-------------|---|------------------------------------|-------|------|
| T46-AAZ0P-1 | High Visibility Amber 4" Round Strobe Amber Lens Grommet Pigtail Connector  | 0.223A - 0.277A<br>(0.075 average) |       | 100  |
| T46-AAZFP-1 | High Visibility Amber 4" Round Strobe Amber Lens Flange Pigtail Connector   |                                    |       | 100  |
| T46-ACZ0P-1 | High Visibility Amber 4" Round Strobe Clear Lens Grommet Pigtail Connector  |                                    |       | 100  |
| T46-ACZFP-1 | High Visibility Amber 4" Round Strobe Clear Lens Flange Pigtail Connector   |                                    |       | 100  |



# T68 – 6" High-Visibility Strobe



\* Can be mounted at any angle

- Class 1 & Class 2 certified
- Fits all industry standard 6" round applications
- Grommet or Flange mount, and available in Pigtail, Standard, or with Custom connectors

**• WIRE COLORS**

**Black** - Ground, **White** - Positive

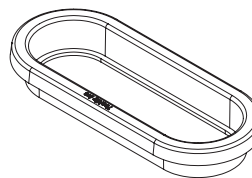
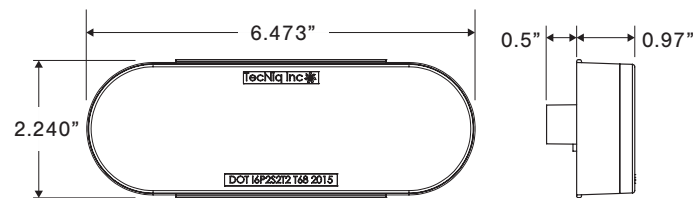

| Part No.    | Part Description (Please see Index, or <a href="http://www.TecNiqInc.com">www.TecNiqInc.com</a> for a complete part list) | Amp Draw      | Color | Pack |
|-------------|---|---------------|-------|------|
| T68-AAZ0A-1 | 6" oval high visibility Strobe grommet mount with amp connector   | 0.125A-0.155A |       | 120  |
| T68-AAZ0P-1 | 6" oval high visibility Strobe grommet mount with pigtail wires   |               |       | 140  |
| T68-AAZ0T-1 | 6" oval high visibility Strobe grommet mount  |               |       | 120  |
| T60-OG00-1  | 6" Oval Grommet   | -             |       | -    |





# T71 – 4” Rectangular LED Strobe/Flasher

- Class 1 & Class 2 certified
- Grommet mount, and available in Pigtail, Standard, or with Custom connectors
- Can be mounted horizontally, vertically, or at any angle
- Durable impact resistant lens

**• WIRE COLORS**

**Black** - Ground, **White** - Positive

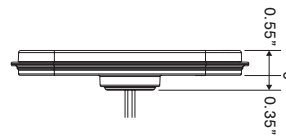
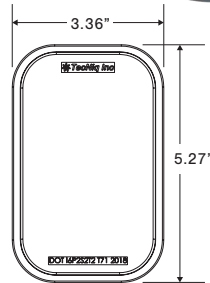

| Part No.   | Part Description (Please see Index, or <a href="http://www.TecNiqInc.com">www.TecNiqInc.com</a> for a complete part list) | Amp Draw      | Color | Pack |
|------------|---|---------------|-------|------|
| T71-0G00-1 | T71 Grommet   |               |       | -    |
| T71-AAZA-1 | 4" Rectangular Class 1 Amber AutoSync Flasher   |               |       | 24   |
| T71-AAZP-1 | 4" Rectangular Class 1 Amber AutoSync Flasher w/Pigtails  | 0.26A - 0.34A |       | 24   |
| T71-AAZT-1 | Rectangular 8 LED Amber Strobe Horiz. Grommet Mnt Amber Lens 3 Pole   |               |       | 24   |



# T67 – 6” Oval Diffused Strobe

**NEW PRODUCT**

- Class 1 & Class 2 certified
- Amber strobe meets SAE J595 for flashing optical warning devices
- Fits all industry standard 6" round applications

**• WIRE COLORS**

**Amp connector**



\* Currently available in grommet mount with Amp connectors

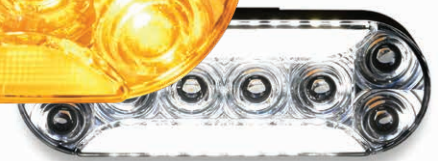
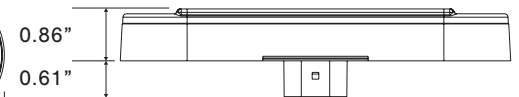
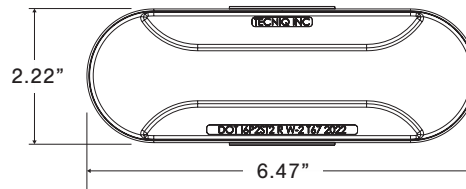

| Part No.    | Part Description (Additional part numbers available at <a href="http://www.TecNiqInc.com">www.TecNiqInc.com</a> ) | Amp Draw                    | Color | Pack |
|-------------|---|-----------------------------|-------|------|
| T67-AWZ0A-1 | 6" Oval Grommet, Amber Flasher Diffuse Reverse t w AMP  | 0.575A (± 0.085A)           |       | TBD  |
| T67-RC0A-1  | 6" Oval Grommet, RED stop Diffuse Tail w AMP  |                             |       | TBD  |
| T67-RC0A-1  | 6" Oval Grommet, RED stop Diffuse Tail w AMP  | 0.170A (± 0.030A) Stop/Turn |       |      |
| T67-RC0A-1  | 6" Oval Grommet, RED stop Diffuse Tail w AMP  | 0.075A (± 0.012A) Tail      |       |      |



# K30 – Grille Light/Ancillary Flasher

**NEW OPTIONS**

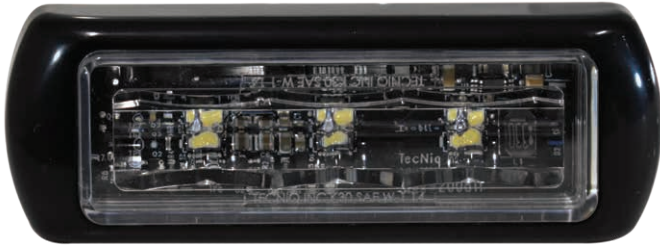

\*Steady Burn & Steady Flasher models now available

**\*(2) Bracket designs now available for (3), (6), and (12) LED models. See Website for part numbers and specs.**

- All K30s meet **Class 1 SAE** flasher standards
- (15) programmable flash patterns
- Stainless Steel bezel available for (3) & (6) LED models

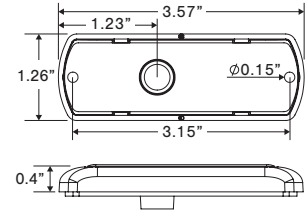

| Part No.    | Part Description (Please see Index, or <a href="http://www.TecNiqInc.com">www.TecNiqInc.com</a> for a complete part list) | Amp Draw      | Color | Pack |
|-------------|---|---------------|-------|------|
| K30-AC030-1 | Amber Grille Flasher 3 LED Clear Lens   | 0.48A - 0.65A |       | 80   |
| K30-BC030-1 | Blue Grille Flasher 3 LED Clear Lens  |               |       | 80   |
| K30-GC030-1 | Green Grille Flasher 3 LED Clear Lens   |               |       | 80   |
| K30-RC030-1 | Red Grille Flasher 3 LED Clear Lens   |               |       | 80   |



\*Stainless Steel Trim Rings available for 3,6, and 12 LED models

- (6 & 12) LED models available in **Dual colors including:** Amber/Blue, Amber/Green, Amber/White, Blue/White, Green/Red, Green/White, Red/White



\*Steady Burn & Steady Flasher models now available

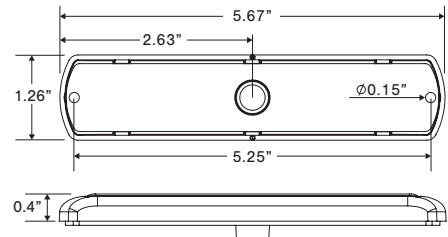

| Part No.    | Part Description (Please see Index, or <a href="http://www.TecNiqInc.com">www.TecNiqInc.com</a> for a complete part list) | Amp Draw      | Color | Pack |
|-------------|---|---------------|-------|------|
| K30-AC060-1 | Amber Grille Flasher 6 LED Clear Lens   | 1.00A - 1.30A |       | 100  |
| K30-BC060-1 | Blue Grille Flasher 6 LED Clear Lens  |               |       | 100  |
| K30-GC060-1 | Green Grille Flasher 6 LED Clear Lens   |               |       | 100  |
| K30-RC060-1 | Red Grille Flasher 6 LED Clear Lens   |               |       | 100  |

**• WIRE COLORS ALL MODELS**  
**Black - Ground, Red - Positive**

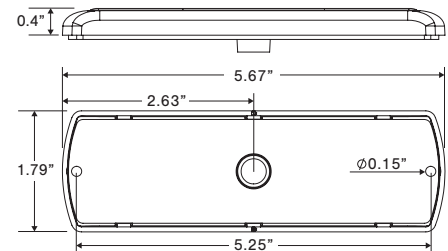
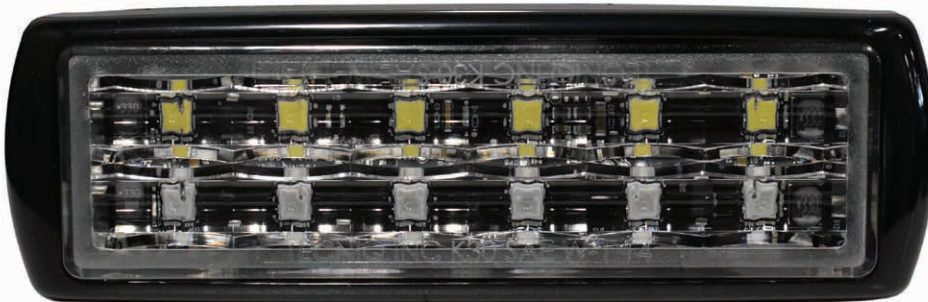

| Part No.    | Part Description (Please see Index, or <a href="http://www.TecNiqInc.com">www.TecNiqInc.com</a> for a complete part list) | Amp Draw      | Color | Pack |
|-------------|---|---------------|-------|------|
| K30-AC060-1 | Amber Grille Flasher 6 LED Clear Lens   | 1.00A - 1.30A |       | 100  |
| K30-BC060-1 | Blue Grille Flasher 6 LED Clear Lens  |               |       | 100  |
| K30-GC060-1 | Green Grille Flasher 6 LED Clear Lens   |               |       | 100  |
| K30-RC060-1 | Red Grille Flasher 6 LED Clear Lens   |               |       | 100  |

Strobes & Flashers





## K40 – 5" x 3.3" Emergency Flasher w/AutoSync

- AutoSync® or steady burn models available
- K40 size fits standard competitors mounting holes
- AutoSync technology allows flashers to sync without separate control box



\* Chrome or black bezel and gasket kit sold separately

### • WIRE COLORS

- Black** - Ground, **Red** - Positive,
- Yellow** - Night Mode,
- White** - Flash Pattern Program,
- Blue** - Wig-Wag (opposite pattern phase)

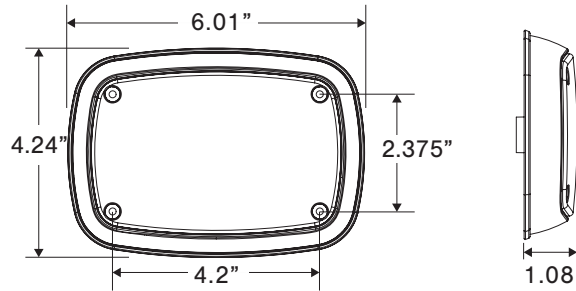

| Part No.   | Part Description (Please see Index, or <a href="http://www.TecNiqInc.com">www.TecNiqInc.com</a> for a complete part list) | Amp Draw                        | Color | Pack |
|------------|---|---------------------------------|-------|------|
| K40-AA00-1 | K40 AutoSync Amber Flasher Lamp Amber Lens  | ≈ 1.1A (average)<br>2.2A (peak) |       | 1    |
| K40-BB00-1 | K40 AutoSync Blue Flasher Lamp Blue Lens  |                                 |       | 1    |
| K40-GG00-1 | K40 AutoSync Green Flasher Lamp Green Lens  |                                 |       | 1    |
| K40-RR00-1 | K40 AutoSync Red Flasher Lamp Red Lens  |                                 |       | 1    |



## K50 – 5" x 2" Emergency Flasher w/AutoSync

- AutoSync® or steady burn models available
- K50 size fits standard competitors mounting holes
- AutoSync technology allows flashers to sync without separate control box



\* Chrome or black bezel and gasket kit sold separately

### • WIRE COLORS

- Black** - Ground, **Red** - Positive,
- Yellow** - Night Mode,
- White** - Flash Pattern Program,
- Blue** - Wig-Wag (opposite pattern phase)

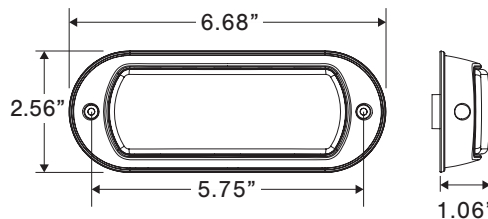

| Part No.   | Part Description (Please see Index, or <a href="http://www.TecNiqInc.com">www.TecNiqInc.com</a> for a complete part list) | Amp Draw                        | Color | Pack |
|------------|---|---------------------------------|-------|------|
| K50-AA00-1 | K50 AutoSync Amber Flasher Lamp Amber Lens  | ≈ 0.9A (average)<br>1.8A (peak) |       | 1    |
| K50-BB00-1 | K50 AutoSync Blue Flasher Lamp Blue Lens  |                                 |       | 1    |
| K50-GG00-1 | K50 AutoSync Green Flasher Lamp Green Lens  |                                 |       | 1    |
| K50-RR00-1 | K50 AutoSync Red Flasher Lamp Red Lens  |                                 |       | 1    |

Strobes & Flashers





# K60 – 6”x4” Emergency Flasher w/AutoSync

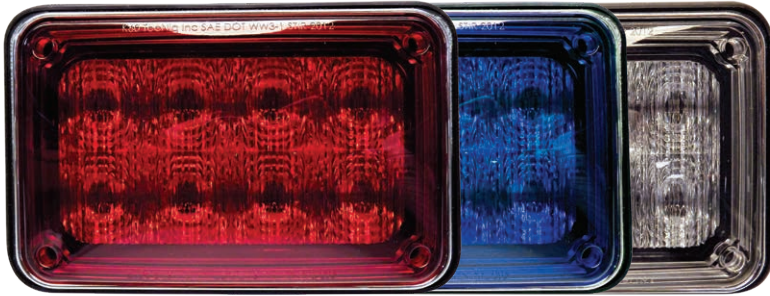

\*K60 Also available with a Quad Bezel for DOT regulated clusters - see website for complete details



- AutoSync® or steady burn models available
- K60 size fits standard competitors mounting holes
- Sequential arrow pattern available
- **DOT** Stop/Tail/Turn Reverse models available

**• WIRE COLORS**

**Black** - Ground, **Red** - Positive, **Yellow** - Low/Night Mode

**White** - Flash Pattern Program, **Blue** - Wig-Wag (opposite pattern phase)

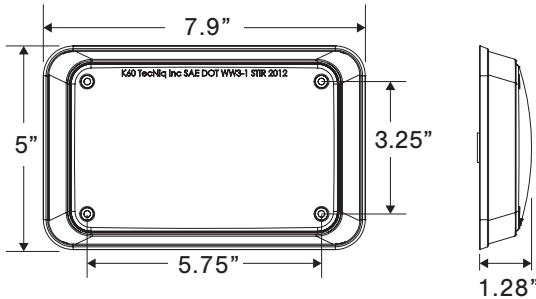

| Part No.   | Part Description (Please see Index, or <a href="http://www.TecNiqInc.com">www.TecNiqInc.com</a> for a complete part list) | Amp Draw                         | Color | Pack |
|------------|---|----------------------------------|-------|------|
| K60-AA00-1 | K60 AutoSync Amber Flasher Lamp Amber Lens  | ≈ 1.25A (average)<br>2.5A (peak) |       | 1    |
| K60-BB00-1 | K60 AutoSync Blue Flasher Lamp Blue Lens  |                                  |       | 1    |
| K60-GG00-1 | K60 AutoSync Green Flasher Lamp Green Lens  |                                  |       | 1    |
| K60-RR00-1 | K60 AutoSync Red Flasher Lamp Red Lens  |                                  |       | 1    |

Strobes & Flashers



# K70 – 7”x3” Emergency Flasher w/AutoSync



\*Chrome or black bezel and gasket kit sold separately

- AutoSync® or steady burn models available
- K70 size fits standard competitors mounting holes
- Sequential arrow pattern available
- **DOT** Stop/Tail/Turn Reverse models available

**• WIRE COLORS**

**Black** - Ground, **Red** - Positive, **Yellow** - Low/Night Mode

**White** - Flash Pattern Program, **Blue** - Wig-Wag (opposite pattern phase)

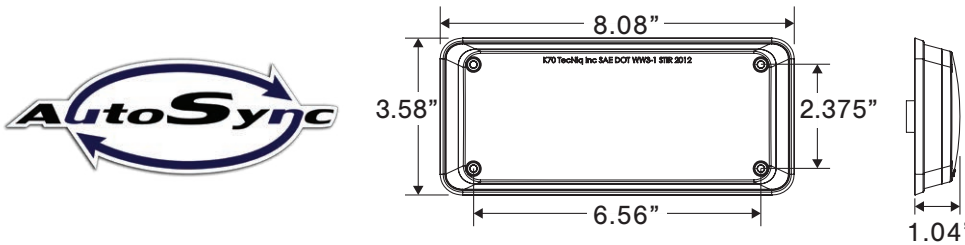

| Part No.   | Part Description (Please see Index, or <a href="http://www.TecNiqInc.com">www.TecNiqInc.com</a> for a complete part list) | Amp Draw                         | Color | Pack |
|------------|---|----------------------------------|-------|------|
| K70-AA00-1 | K70 AutoSync Amber Flasher Lamp Amber Lens  | ≈ 1.25A (average)<br>2.5A (peak) |       | 1    |
| K70-BB00-1 | K70 AutoSync Blue Flasher Lamp Blue Lens  |                                  |       | 1    |
| K70-GG00-1 | K70 AutoSync Green Flasher Lamp Green Lens  |                                  |       | 1    |
| K70-RR00-1 | K70 AutoSync Red Flasher Lamp Red Lens  |                                  |       | 1    |



# K90 – 9”x7” Emergency Flasher w/AutoSync

- K90 can be purchased as a Flasher/Scene combo
- K90 size fits standard competitors mounting holes
- Sequential arrow pattern available
- **DOT** Stop/Tail/Turn Reverse models available

**WIRE COLORS**

**Black** - Ground, **Red** - Positive, **Yellow** - Low/Night Mode

**White** - Flash Pattern Program, **Blue** - Wig-Wag (opposite pattern phase)

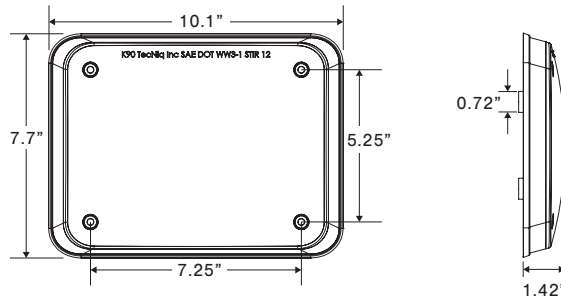

\* Chrome or black bezel and gasket kit sold separately



| Part No.   | Part Description (Please see Index, or <a href="http://www.TecNiqInc.com">www.TecNiqInc.com</a> for a complete part list) | Amp Draw                      | Color | Pack |
|------------|---|-------------------------------|-------|------|
| K90-AA00-1 | K90 AutoSync Amber Amber Flasher Lamp Amber Lens  | ≈ 2.5A (average)<br>5A (peak) |       | 1    |
| K90-BB00-1 | K90 AutoSync Blue Blue Flasher Lamp Blue Lens   |                               |       | 1    |
| K90-RR00-1 | K90 AutoSync Red Red Flasher Lamp Red Lens  |                               |       | 1    |
| K90-WC00-1 | K90 AutoSync White White Flasher Lamp Clear Lens  |                               |       | 1    |



# K10 – Flashing Beacon w/AutoSync

**NEW OPTIONS**

- Both 12V and 24V models are **Class 1 & Class 2 certified**
- Available in single flash pattern or with AutoSync technology
- Designed to mount on a flat surface or attach to pole mount

**WIRE COLORS**

**Black** - Ground, **Red** - Positive, **White** - Flash Pattern Selection, **Yellow** - Low/Night Mode

**White/Blue** - Wig-Wag (opposite pattern phase)



\* Now available in Amber, Red, Green, Blue, and Amber/Green, Amber/White



\* Optional steel brush guard

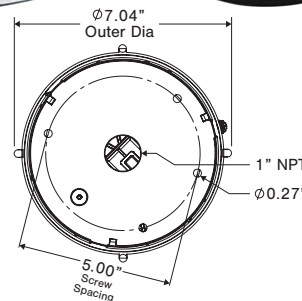
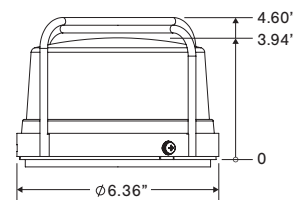

| Part No.   | Part Description (Please see Index, or <a href="http://www.TecNiqInc.com">www.TecNiqInc.com</a> for a complete part list) | Amp Draw                                      | Color | Pack |
|------------|---|---|-------|------|
| K10-OCB0-1 | K10 Chrome Brush Guard  |   |       | 1    |
| K10-AA0P-1 | K10 Amber Beacon Light Amber Lens Single Flash Pattern W/Pigtail  | Hi - ≈0.7A (average)<br>Lo - ≈0.17A (average) |       | 1    |
| K10-AAAD-1 | K10 Beacon Light Amber Lens 1 Flash Pattern W/Pigtail Deutsch/Brush   |   |       | 1    |
| K10-AADP-1 | Amber Beacon Light Amber Lens Autosync Multi-Flash Pattern W/Pigtail  |   |       | 1    |





## K60 – 6"x4" Scene Light



\* Chrome or black bezel and gasket kit sold separately



- Produces 2500 lumens
- Light beam from horizontal to the base of the vehicle ensures continual ground coverage
- Fits standard mounting holes for easy upgrade

- **WIRE COLORS**  
**Black** - Ground,  
**Red** - High Intensity,  
**Yellow** - Low/Night Mode

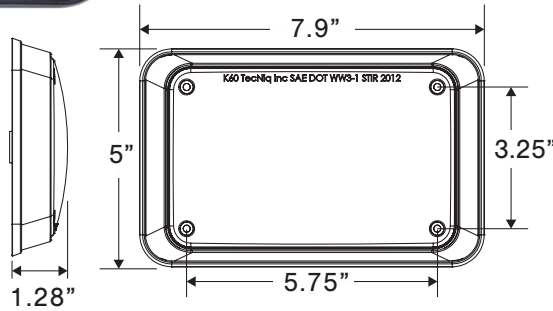
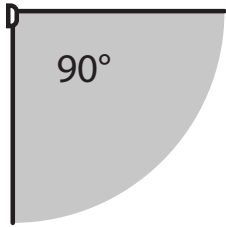

| Part No.   | Part Description (Please see Index, or <a href="http://www.TecNiqInc.com">www.TecNiqInc.com</a> for a complete part list) | Amp Draw         | Color  | Pack |
|------------|---|------------------|--|------|
| K60-1B00-1 | K60 Black Trim and Gasket Kit   |                  |  | 1    |
| K60-1C00-1 | K60 Chrome Trim and Gasket Kit  |                  |  | 1    |
| K60-SW00-1 | K60 Scene Light   | ≈1.20A @ 12.8VDC | <input type="checkbox"/> <input type="radio"/> | 1    |
| K60-SW0F-1 | K60 Scene Light W/2P Duetsch Connector  |                  | <input type="checkbox"/> <input type="radio"/> | 1    |

Scene & Task Lighting



## K70 – 7"x3" Scene Light

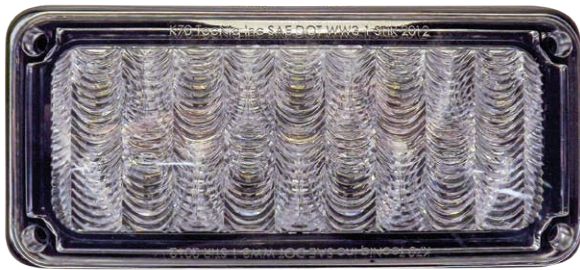

\* Chrome or black bezel and gasket kit sold separately



- Produces 2500 lumens
- Light beam from horizontal to the base of the vehicle ensures continual ground coverage
- Fits standard mounting holes for easy upgrade

- **WIRE COLORS**  
**Black** - Ground,  
**Red** - High Intensity,  
**Yellow** - Low/Night Mode

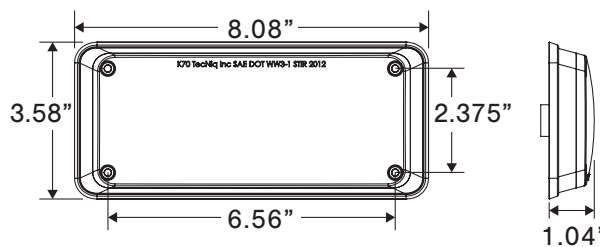
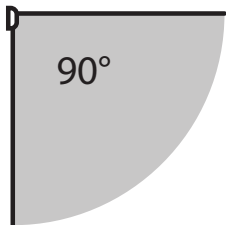

| Part No.   | Part Description (Please see Index, or <a href="http://www.TecNiqInc.com">www.TecNiqInc.com</a> for a complete part list) | Amp Draw         | Color  | Pack |
|------------|---|------------------|--|------|
| K70-0100-1 | K60 & K70 Anchor/Screw Kit  |                  |  | 1    |
| K70-1B00-1 | K70 Black Trim and Gasket Kit   |                  |  | 1    |
| K70-1C00-1 | K70 Chrome Trim and Gasket Kit  |                  |  | 1    |
| K70-SW00-1 | K70 High Output Scene Light   | ≈1.20A @ 12.8VDC | <input type="checkbox"/> <input type="radio"/> | 1    |





# K90 – 9”x7” Scene Light

- Produces 5000 lumens
- Light beam from horizontal to the base of the vehicle ensures continual ground coverage
- Fits standard mounting holes for easy upgrade
- K90 available as Flasher/Scene combo light

- WIRE COLORS**  
**Black** - Ground,  
**Red** - High Intensity,  
**Yellow** - Low/Night Mode



\* Chrome or black bezel and gasket kit sold separately

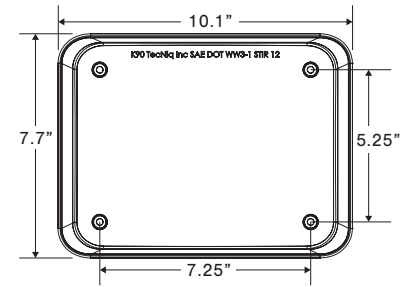
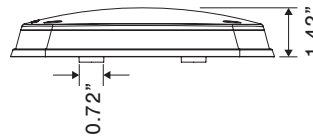

| Part No.   | Part Description (Please see Index, or <a href="http://www.TecNiqInc.com">www.TecNiqInc.com</a> for a complete part list) | Amp Draw       | Color  | Pack |
|------------|---|----------------|--|------|
| K90-0100-1 | K90 Anchor/Screw Kit  |                |  | 1    |
| K90-1C00-1 | K90 Chrome Trim and Gasket Kit  |                |  | 1    |
| K90-ST0-1  | K90 Steady Red STT Bottom Scene Clear Lens  |                | <input checked="" type="checkbox"/> <input type="checkbox"/> | 1    |
| K90-SW00-1 | K90 High Output Scene Light   | ≈2.90A – 3.50A | <input type="checkbox"/> <input type="checkbox"/>            | 1    |



# E100 – High Intensity Scene Light

**NEW PRODUCT**

- Produces over 30,000 lumens
- Fully sealed construction
- Over 376 LEDs provide an extremely efficient and optimally projected light
- Optics designed to reduce eye glare
- Available in Black or White

- WIRE COLORS**  
**Black** - Ground, **Red** - Positive

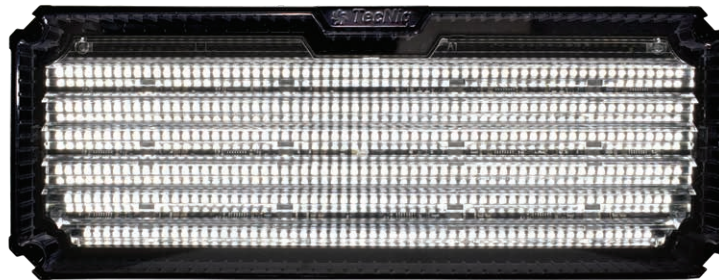

\* Chrome bezel sold separately

\* Works with less power than traditional metal halide lamps, leaving more power for other equipment

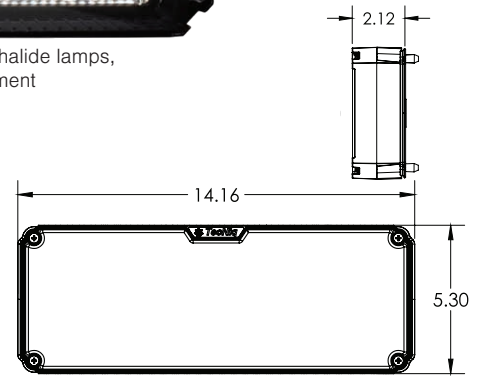
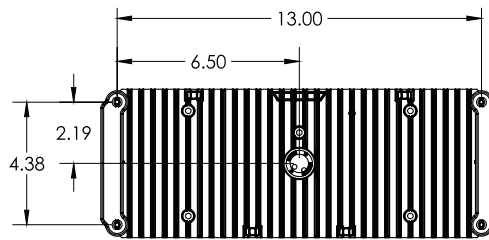

| Part No.     | Part Description (Please see Index, or <a href="http://www.TecNiqInc.com">www.TecNiqInc.com</a> for a complete part list) | Amp Draw    | Color   | Pack |
|--------------|---|-------------|---|------|
| E100-0BR32-1 | E100 Brow Mount Brackets Black w/ 3.2" Radius.  |             |   | -    |
| E100-0PMKB-1 | E100 Pole Mount Kit Black   |             |   | -    |
| E100-WB00-1  | High Int Scene Light 12/24V dc Sf Mt Black Housing  | 12V - 16.5A | <input type="checkbox"/> <input type="checkbox"/> | -    |
| E100-WW00-1  | High Int Scene Light 12/24V dc Sf Mt white housing  | 24V - 9A    | <input type="checkbox"/> <input type="checkbox"/> | -    |



# E100 – Pole Mount Bracket Accessory

**NEW PRODUCT**

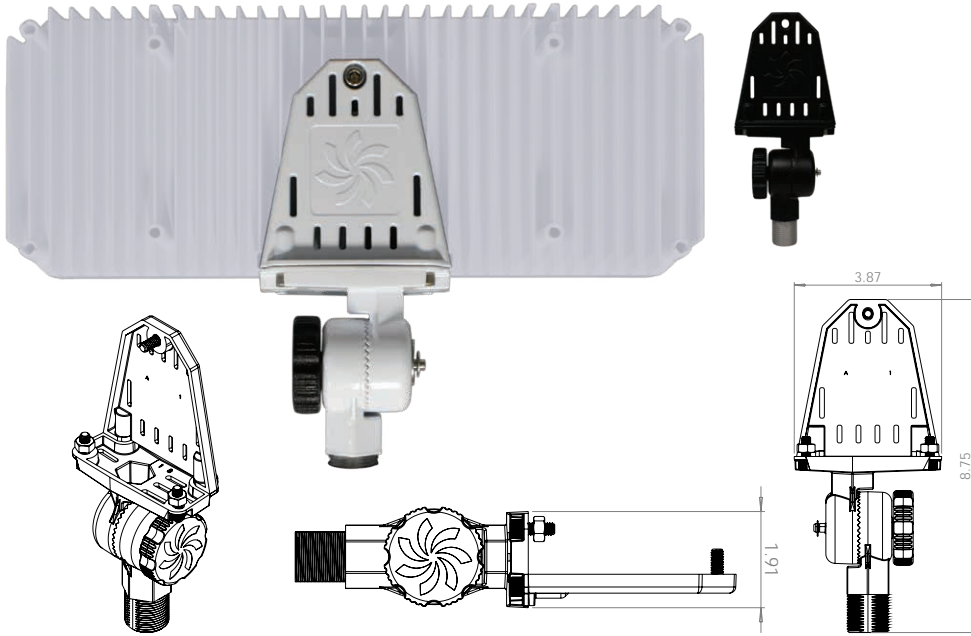

- Bracket allows 180° of flexibility
- Fully sealed construction
- Over 376 LEDs provide an extremely efficient and optimally projected light
- Optics designed to reduce eye glare
- Available in Black or White

• **WIRE COLORS**  
**Black** - Ground, **Red** - Positive



| Part No.     | Part Description (Please see Index, or <a href="http://www.TecNiqInc.com">www.TecNiqInc.com</a> for a complete part list) | Amp Draw                | Color  | Pack |
|--------------|---|-------------------------|--|------|
| E100-OPMKB-1 | E100 Pole Mount Kit Black   |                         |  | -    |
| E100-OPMKW-1 | E100 Pole Mount Kit White   |                         |  | -    |
| E100-WBP0-1  | High Intensity Scene Light 12/24Vdc Pole Mount Black Housing  | 12V - 16.5A<br>24V - 9A | <input type="checkbox"/> <input type="radio"/> | -    |
| E100-WWP0-1  | High Intensity Scene Light 12/24vdc Pole Mount White Housing  |                         | <input type="checkbox"/> <input type="radio"/> | -    |

Scene & Task Lighting



# E110 – 360° High Power Spotlight w/Remote

**NEW PRODUCT**



- ALL NEW 360° High Powered Lighting from TecNiq
- Low electrical noise with spot light distribution for precise visibility
- Remote control provides up to 30' of operational range
- Available in Black or White body

• **WIRE COLORS**  
**Black** - Ground, **Red** - Positive



| Part No.     | Part Description (Please see Index, or <a href="http://www.TecNiqInc.com">www.TecNiqInc.com</a> for a complete part list) | Amp Draw | Color | Pack |
|--------------|---|----------|-------|------|
| E110-0GRC0-1 | E110 Remote Control Gray  |          |       |      |
| E110-0GRC0-1 | E110 Remote Control Spotlight   |          |       |      |



# D16 – High Output Race/Task Light

- Surface mount Race/Task light
- Provides 4400 lumens of light for inside or outside of trailer
- Guaranteed, potted circuit board
- Great “Race Light” for working on vehicles, atv’s, etc..
- Now available with 45° or 0° tilt

**• WIRE COLORS**

**Black** - Positive, **White** - Ground

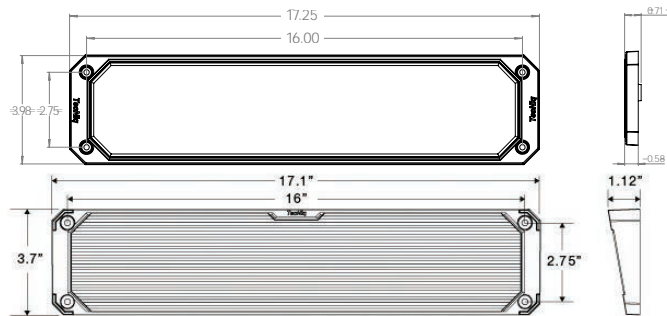
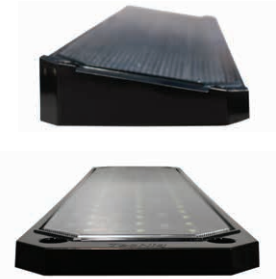

| Part No.   | Part Description (Please see Index, or <a href="http://www.TecNiqInc.com">www.TecNiqInc.com</a> for a complete part list) | Amp Draw    | Color  | Pack |
|------------|---|-------------|--|------|
| D16-WB00-1 | 16in High Powered Area Light  | 2.55A-3.45A | <input type="checkbox"/> <input type="radio"/> | 24   |
| D16-WBF0-1 | 16in High Powered Area Light Black Base Flat Model  |             | <input type="checkbox"/> <input type="radio"/> | 24   |
| D16-WG00-1 | 16in High Powered Area Light Gray Base  |             | <input type="checkbox"/> <input type="radio"/> | 24   |
| D16-WW00-1 | 16in High Powered Area Light White Base   |             | <input type="checkbox"/> <input type="radio"/> | 24   |



# D18 – Heavy Duty Scene Light

- Available in Standard (5k) or Premium (8k) lumen outputs
- Water resistant design with FR-4 circuit boards for higher quality
- Heavy duty Black, White, or Silver aluminum extrusion with 30° tilt for increased ground illumination
- Now available in 6”, 12”, or 24” models

**• WIRE COLORS**

**Black** - Positive, **White** - Ground

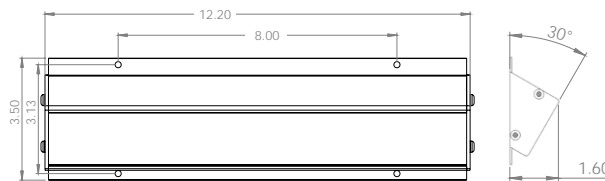
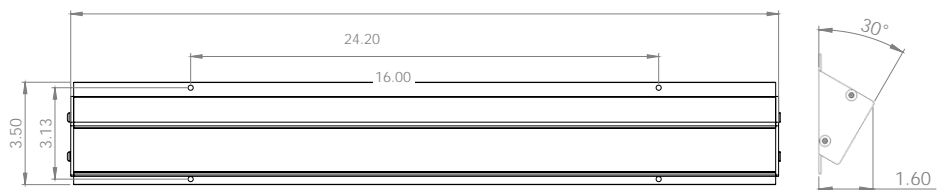

| Part No.    | Part Description (Please see Index, or <a href="http://www.TecNiqInc.com">www.TecNiqInc.com</a> for a complete part list) | Amp Draw      | Color  | Pack |
|-------------|---|---------------|--|------|
| D18-WA12-1  | Aluminum Exterior Light 12in Clear Anodize  | 1.32A - 1.80A | <input type="checkbox"/> <input type="radio"/> | TBD  |
| D18-WB010-1 | Aluminum Exterior Area Light 12in   | Standard      | <input type="checkbox"/> <input type="radio"/> | TBD  |
| D18-WBP0-1  | Aluminum Exterior Area Light Premium 24in   | 4.85A - 6.55A | <input type="checkbox"/> <input type="radio"/> | TBD  |
| D18-WWP24-1 | Aluminum Exterior Light Premium 24in White  | Premium       | <input type="checkbox"/> <input type="radio"/> | TBD  |

Scene & Task Lighting





# E10 – Ground/Pump/Auxillary Light



- Extra wide area of illumination covers a multitude of applications
- Water & vibration proof
- Remote control provides up to 30' of operational range
- Available colors include: **White, Green, Red, and Blue**

• **WIRE COLORS**  
**White** - Ground, **Black** - Positive

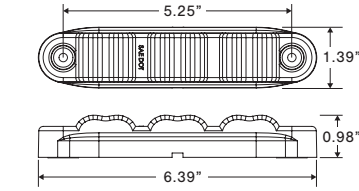

\* Seen here with bracket

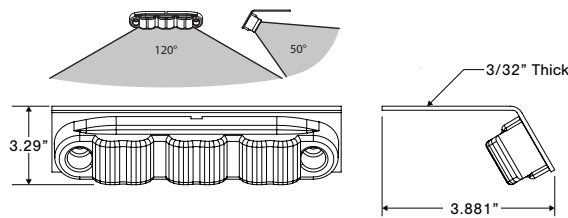
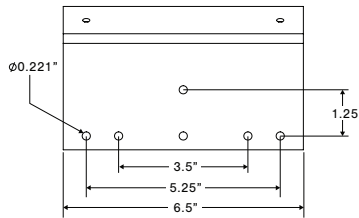

| Part No.   | Part Description (Please see Index, or <a href="http://www.TecNiqInc.com">www.TecNiqInc.com</a> for a complete part list) | Amp Draw      | Color  | Pack |
|------------|---|---------------|--|------|
| E10-G000-1 | EV Ground Light Green   | 0.34A - 0.46A | <input checked="" type="checkbox"/> <input type="checkbox"/> | 10   |
| E10-GS00-1 | EV Ground/Pump Panel Green Light with SS Bracket  | 0.34A - 0.46A | <input checked="" type="checkbox"/> <input type="checkbox"/> | 10   |
| E10-W000-1 | EV Ground/Pump Panel Light  | 0.36A - 0.44A | <input type="checkbox"/> <input type="checkbox"/>            | 10   |
| E10-WS00-1 | EV Ground/Pump Panel Light with SS Bracket  | 0.36A - 0.44A | <input type="checkbox"/> <input type="checkbox"/>            | 10   |

Scene & Task Lighting



# T23 – Tank/Level Light



- Extra wide area of illumination covers a multitude of applications
- Water and vibration proof light
- Remote control provides up to 30' of operational range
- Available colors include: White, Green, Red, Blue, and

• **WIRE COLORS**  
**White** - Ground, **Black** - Positive

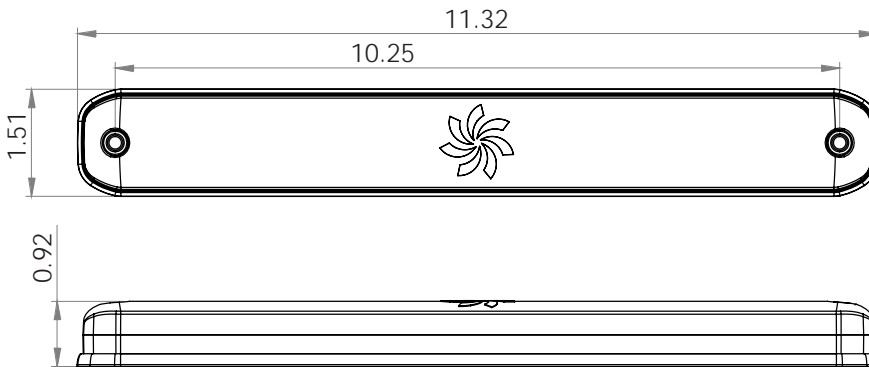

| Part No.   | Part Description (Please see Index, or <a href="http://www.TecNiqInc.com">www.TecNiqInc.com</a> for a complete part list) | Amp Draw          | Color  | Pack |
|------------|---|-------------------|--|------|
| T23-4F0F-1 | 4-Color Indicator Light 12v w/ xTM06-6S   | 0.33A - Green     | <input checked="" type="checkbox"/> <input type="checkbox"/> | TBD  |
| T23-4F10-1 | Load Lamp pigtail wires   | 0.195A Blue       | <input checked="" type="checkbox"/> <input type="checkbox"/> | TBD  |
| T23-4F1F-1 | Load Lamp Deutch DTM06-6S   | 0.255A Yellow/Red | <input checked="" type="checkbox"/> <input type="checkbox"/> | TBD  |



## D30 – Load Ramp Light

- Extremely durable surface mounted load lamp
- Aluminum heat sink housing
- 2000 lumens of bright white light
- Includes TPE gasket



### • WIRE COLORS

**White** - Ground, **Black** - Positive

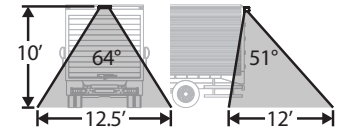
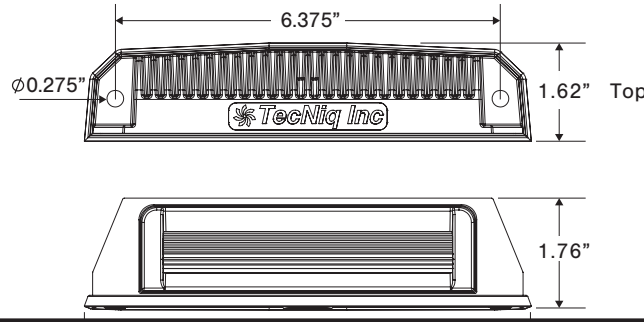

| Part No.   | Part Description (Please see Index, or <a href="http://www.TecNiqInc.com">www.TecNiqInc.com</a> for a complete part list) | Amp Draw    | Color  | Pack |
|------------|---|-------------|--|------|
| D30-WB00-1 | LED High Output Surface Mount Load Light  |             | <input type="checkbox"/> <input type="radio"/> | 10   |
| D30-WB0B-1 | LED High Output Surface Mount Load Light W/180 Bullets  | 1.3A - 1.9A | <input type="checkbox"/> <input type="radio"/> | 10   |
| D30-WW0B-1 | LED High Output Surface Mount Load Light White Housing W/180 Bullets  |             | <input type="checkbox"/> <input type="radio"/> |      |



## P10 – Flush Mounted Spreader Light

- Available with (4) high-performance white LEDs or (2) white and (2) night-vision red LEDs
- Provides 1300 lumens (700+155 in red/white combo)
- Designed for extreme weather
- Completely waterproof



\* Built with anodized and powder coated aluminum bodies and available in Black or White

### • WIRE COLORS

**White** - Ground, **Black** - Positive

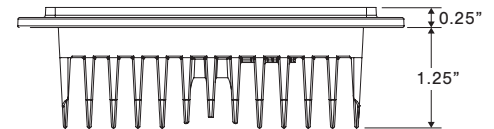
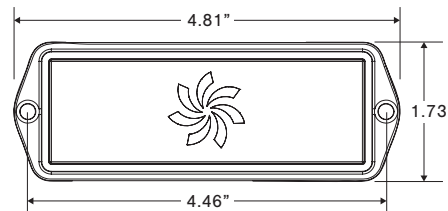

| Part No.   | Part Description (Please see Index, or <a href="http://www.TecNiqInc.com">www.TecNiqInc.com</a> for a complete part list) | Amp Draw         | Color  | Pack |
|------------|---|------------------|--|------|
| P10-WBFP-1 | Spreader Light, White LED, Flush Mt. <b>Black Finish</b> , Pigtail Wires  | ≈1.2A            | <input type="checkbox"/> <input type="radio"/> | 2    |
| P10-WRBF-1 | SSpreader Light, White & Red LED, Flush Mt. <b>Black Finish</b> , Pigtail Wires   | ≈0.6A +0.3A(red) | <input type="checkbox"/> <input type="radio"/> | 2    |
| P10-WRFP-1 | Spreader Light, White & Red LED, Flush Mt. <b>White Finish</b> , Pigtail Wires  | ≈0.6A +0.3A(red) | <input type="checkbox"/> <input type="radio"/> | 2    |
| P10-WWFP-1 | Spreader Light, White LED, Flush Mt. <b>White Finish</b> , Pigtail Wires  | ≈1.2A            | <input type="checkbox"/> <input type="radio"/> | 2    |



# P11 – Surface Mounted Spreader Light



\* Now available in black

- Available with (4) high-performance white LEDs or (2) white and (2) night-vision red LEDs
- Provides 1400 lumens (825+160 in red/white combo)
- Designed for extreme weather
- Completely waterproof

• **WIRE COLORS**  
**White** - Ground, **Black** - Positive

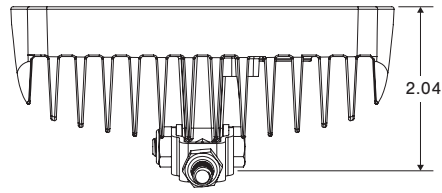
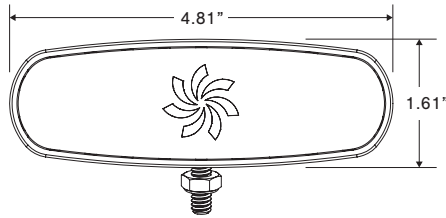

| Part No.    | Part Description (Please see Index, or <a href="http://www.TecNiqInc.com">www.TecNiqInc.com</a> for a complete part list) | Amp Draw              | Color  | Pack |
|-------------|---|-----------------------|--|------|
| P11-WBFP-1  | Spreader Light, White LED Surface Mt. Black Finish Pigtail Wires  | 1.6A @ 12V            | <input type="checkbox"/> <input type="radio"/> | 2    |
| P11-WWFP-1  | Spreader Light, White LED Surface Mt. White Finish Pigtail Wires  | 0.8A @ 24V            | <input type="checkbox"/> <input type="radio"/> | 2    |
| P11-WRBFP-1 | Spreader Light, White & Red LED, Surface Mt. Black  | 0.8A +0.3(red) @ 12V  | <input type="checkbox"/> <input type="radio"/> | 2    |
| P11-WRFP-1  | Spreader Light, White & Red LED, Surface Mt. White Finish, Pigtail Wires  | 0.4A +0.15(red) @ 24V | <input type="checkbox"/> <input type="radio"/> | 2    |

Scene & Task Lighting



# E61 – Surface Mount Auxillary Light



- Surface mount design makes it suitable for many applications where a wide spectrum of bright light is desired
- Water proof design with 1400 lumens of output
- Anodized cast aluminum heatsink with 316 Stainless steel cover provides great look and protection
- Form fitting gasket to protect vehicle/surface finishes

• **WIRE COLORS**  
**Black** - Ground, **White** - Positive

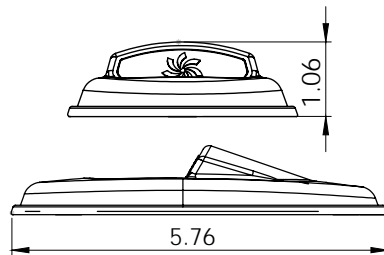
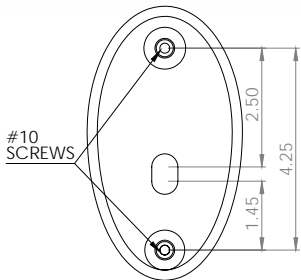

| Part No.   | Part Description (Please see Index, or <a href="http://www.TecNiqInc.com">www.TecNiqInc.com</a> for a complete part list) | Amp Draw      | Color  | Pack    |
|------------|---|---------------|--|---------|
| E61-WS00-1 | Surface Mount Docking Light   | 0.85A - 1.15A | <input type="checkbox"/> <input type="radio"/> | 6 Pairs |
| E61-WS0E-1 | Surface Mount Docking Light W/Metri-Pack Connector  |               | <input type="checkbox"/> <input type="radio"/> | 6 Pairs |
| E61-WS0F-1 | Surface Mount Docking Light w xT04-2P Connector   |               | <input type="checkbox"/> <input type="radio"/> | 6 Pairs |





# P02/P04/P06 – Steelhead Heavy Duty Work Lights

- Built for a lifetime of use in the harshest conditions
- Models can be ordered with either a spot or flood feature
- Available in Black or White heavy duty powder coated bodies
- Designed with proprietary thermal management which provides powerful performance in a small package
- Vibration resistant
- Stainless steel mounting hardware included
- Performance over 50,000 hours

\*Now available in Green, Red, Amber, and Blue



**• WIRE COLORS**

**Black** - Ground, **White** - Positive

- **P02** provides 750 Lumens
- **P04** provides 1100 Lumens
- **P06** provides 1900 Lumens

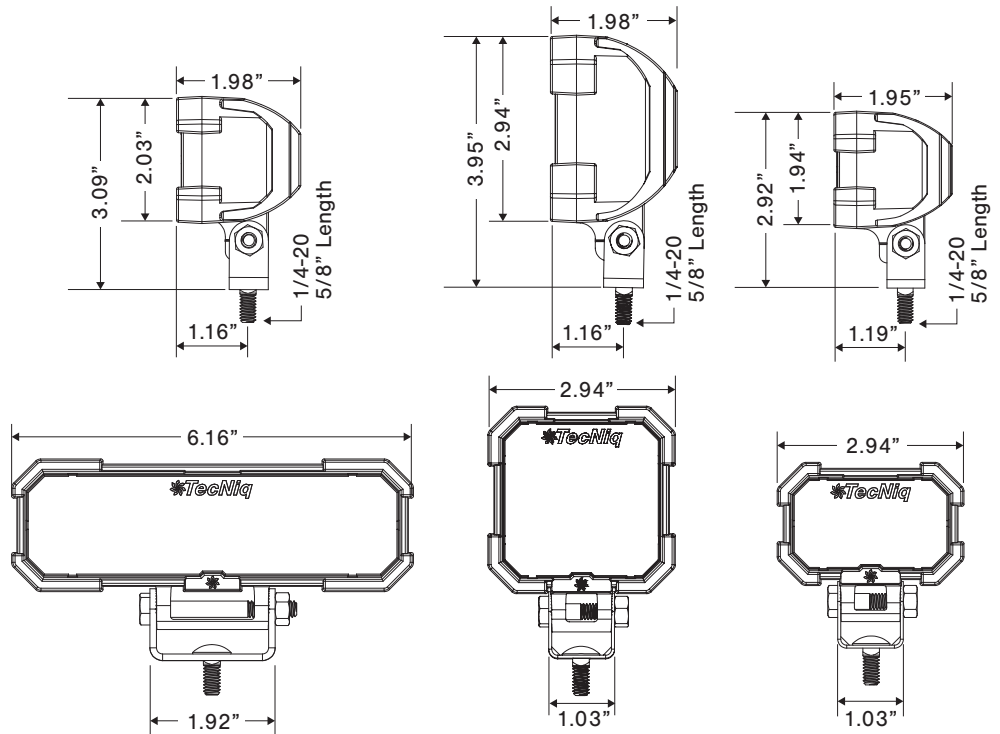
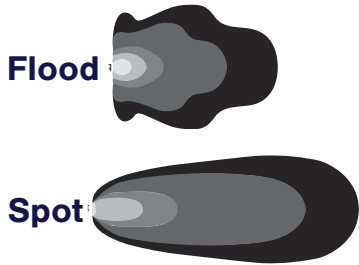

| Part No.   | Part Description (Please see Index, or <a href="http://www.TecNiqInc.com">www.TecNiqInc.com</a> for a complete part list) | Amp Draw | Color   | Pack |
|------------|---|----------|---|------|
| P02-WBFP-1 | SteelHead Flood Lamp 2 LED Black Finish Pigtail Wires   | ≈0.52A   | <input type="checkbox"/> <input type="radio"/>            | 4    |
| P02-WBSP-1 | SteelHead Spot Lamp 2 LED Black Finish Pigtail Wires  |          | <input type="checkbox"/> <input type="radio"/>            | 4    |
| P04-ABFP-1 | Amber SteelHead Flood Lamp 4 LED Black Finish Pigtail Wire  | ≈0.85A   | <input checked="" type="checkbox"/> <input type="radio"/> | 2    |
| P04-ABSP-1 | Amber SteelHead Spot Lamp 4 LED Black Finish Pigtail Wires  |          | <input checked="" type="checkbox"/> <input type="radio"/> | 2    |
| P04-BBFP-1 | Blue SteelHead Flood Lamp 4 LED Black Finish Pigtail Wire   | ≈1.20A   | <input checked="" type="checkbox"/> <input type="radio"/> | 2    |
| P04-BBSP-1 | Blue SteelHead Spot Lamp 4 LED Black Finish Pigtail Wires   |          | <input checked="" type="checkbox"/> <input type="radio"/> | 2    |

Scene & Task Lighting



# D02/D05 – Aerial Lighting Solutions



- 100% sealed and vibration proof
- Up to 100 lamps per string spaced 14" apart
- Installs w/ **3M** adhesive tape on back of each lamp
- Available colors include: White, Green, Red, Blue, and RGB(D05)
- **WIRE COLORS**  
**Black** - Ground,  
**Black w/Gray Dashes** - Positive

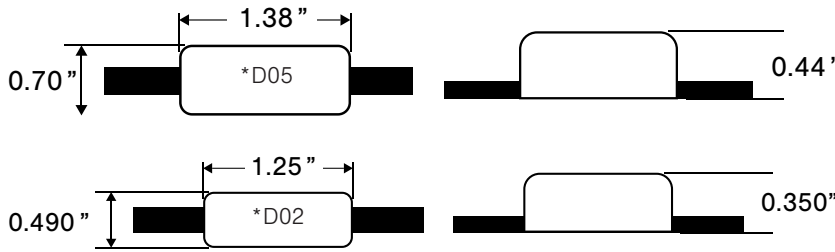

| Part No.   | Part Description (Please see Index, or <a href="http://www.TecNiqInc.com">www.TecNiqInc.com</a> for a complete part list) | Amp Draw       | Color | Pack |
|------------|---|----------------|-------|------|
| D02-A001-1 | Ladder Light Amber 1 Section - 14" Section Length   | 0.06A - 0.08A  | Amber | -    |
| D02-B001-1 | Ladder Light Blue 1 Sections - 14" Section Length   | 0.03A - 0.035A | Blue  | -    |
| D02-W001-1 | Ladder Light White 1 Sections - 14" Section Length  | 0.07A-0.09A    | White | -    |
| D05-3001-1 | Ladder Light RGB 1 Section - 14" Section Length   | Varies         | RGB   | -    |

Area/Accent Lighting



# D03 – Linear Area/Accent Lights



- Available with (3) different mounting covers
- Perfect light for accent or step lighting - white model provides 120 lumens
- Surface install w/(2) screws



- **WIRE COLORS**  
**Black** - Ground, **Color** - Positive

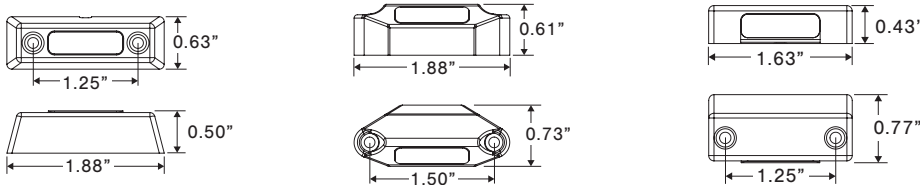
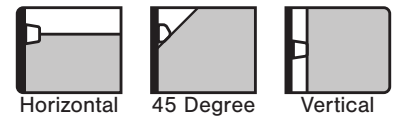

| Part No.   | Part Description (Please see Index, or <a href="http://www.TecNiqInc.com">www.TecNiqInc.com</a> for a complete part list) | Amp Draw       | Color | Pack |
|------------|---|----------------|-------|------|
| D03-3000-1 | Mini Light Linear Body RGB  | Varies         | RGB   | 50   |
| D03-A000-1 | Mini Light Linear Body Amber  | 0.06A - 0.08A  | Amber | 50   |
| D03-B000-1 | Mini Light Linear Body Blue   | 0.03A - 0.035A | Blue  | 50   |
| D03-G000-1 | Mini Light Linear Body Green  |                | Green | 50   |



## D04 – Linear Dragon Lights

- Easy install w/(2) #4 screws
- Output of 53 lumens each
- Available colors include: White, Green, Red, Blue, Amber, Blue, Orange, and UV



**• WIRE COLORS**

**White** - Ground, **Black** - Positive

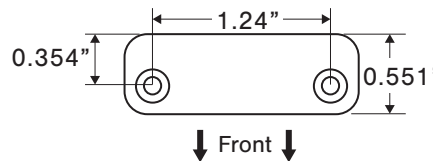
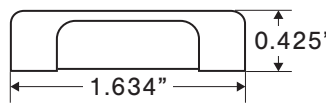
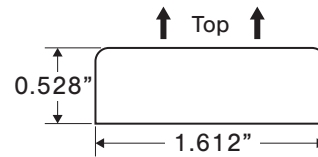
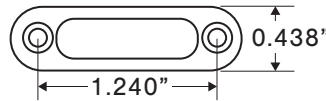

| Part No.   | Part Description (Please see Index, or <a href="http://www.TecNiqInc.com">www.TecNiqInc.com</a> for a complete part list) | Amp Draw    | Color | Pack |
|------------|---|-------------|-------|------|
| D04-A000-1 | Dragon Light Linear Body Amber  | 0.08A-0.12A | Amber | 50   |
| D04-B000-1 | Dragon Light Linear Body Blue   | 0.04A-0.07A | Blue  | 50   |
| D04-D000-1 | Dragon Light Linear Body Deep Red 9"  | 0.08A-0.12A | Red   | 50   |
| D04-G000-1 | Dragon Light Linear Body Green  | 0.04A-0.07A | Green | 50   |



## D06 – 45° Accent/Step Light

- Perfect light for accent, steps, walkways and more
- UV resistant, automotive grade polycarbonate
- 115 lumens of output
- Surface mounts with (2) fasteners



**• WIRE COLORS**

**Black** - Ground, **Color** - Positive

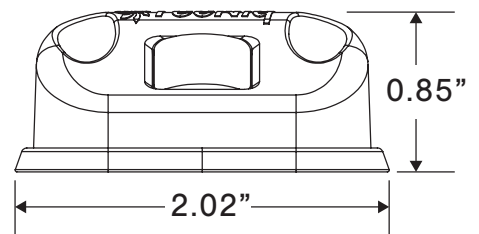
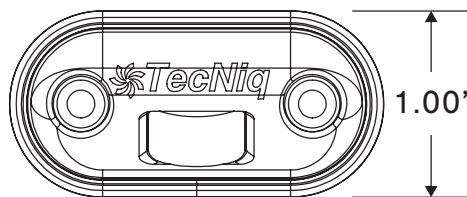

| Part No.   | Part Description (Please see Index, or <a href="http://www.TecNiqInc.com">www.TecNiqInc.com</a> for a complete part list) | Amp Draw      | Color | Pack |
|------------|---|---------------|-------|------|
| D06-0G00-1 | Step Light 45 Deg. Gasket   |               |       | 50   |
| D06-WC00-1 | Step Light White 45 Deg. W/Chrome Case  | 0.11A - 0.14A | White | 50   |

Area/Accent Lighting





# D07 – Linear Area/Accent Lights



\*Horizontal Mount



\*45° Mount



\*Vertical Mount

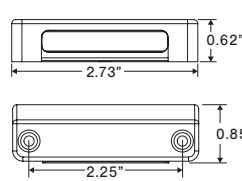
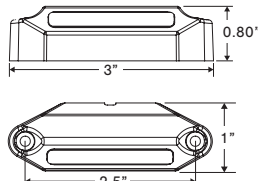
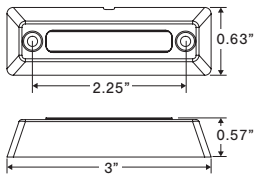

- Available with (3) different mounting covers
- Perfect light for accent or step lighting
- Surface install w/(2) screws
- White model provides 240 lumens
- Single color, or RGB available

**• WIRE COLORS**

**Black** - Ground, **Color** - Positive



Horizontal



45 Degree



Vertical



| Part No.   | Part Description (Please see Index, or <a href="http://www.TecNiqInc.com">www.TecNiqInc.com</a> for a complete part list) | Amp Draw      | Color | Pack |
|------------|---|---------------|-------|------|
| D07-3000-1 | Mini Lamp Body RGB  | Varies        |       | 50   |
| D07-A000-1 | Mini Lamp Body Amber  | 0.12A - 0.14A |       | 50   |
| D07-B000-1 | Mini Lamp Body Blue   |               |       | 50   |
| D07-W000-1 | Mini Lamp Body White  |               |       | 50   |

Area/Accent Lighting



# D14 – Oval Dragon Lights



- Available with (3) different mounting covers
- Perfect light for accent or step lighting
- Surface install w/(2) screws
- White model provides 240 lumens

**• WIRE COLORS**

**Black** - Ground, **Color** - Positive

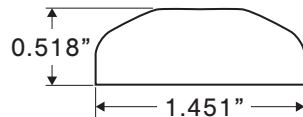
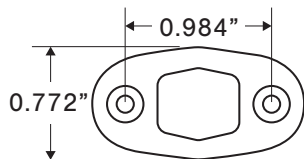

| Part No.   | Part Description (Please see Index, or <a href="http://www.TecNiqInc.com">www.TecNiqInc.com</a> for a complete part list) | Amp Draw    | Color | Pack |
|------------|---|-------------|-------|------|
| D14-A000-1 | Dragon Light Oval Body Amber  | 0.04A-0.07A |       | 50   |
| D14-B000-1 | Dragon Light Oval Body Blue   |             |       | 50   |
| D14-G000-1 | Dragon Light Oval Body Green  |             |       | 50   |
| D14-U000-1 | Dragon Light Oval Body Ultraviolet  |             |       | 50   |



# D17 – Porch/Task Light

- Provides a great light option for boat decks, RV doorways, food truck menu lights, and more
- Output of 540 lumens
- Surface install w/(2) screws
- Available with either front facing application, or 90° light projection

**• WIRE COLORS**

**Black** - Ground, **White** - Positive



\* Available with Stainless Steel cover, Black or White for 90° model

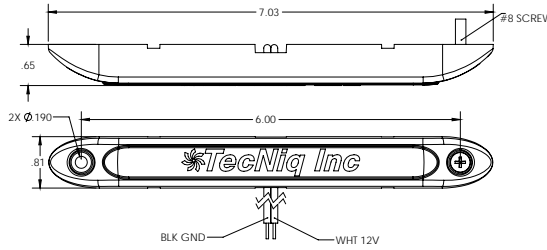
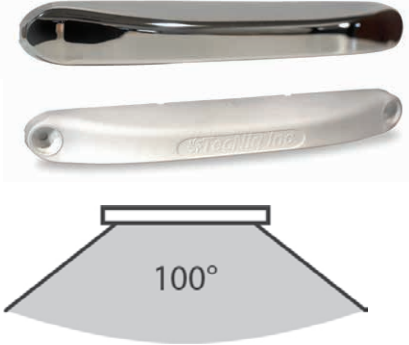

| Part No.   | Part Description (Please see Index, or <a href="http://www.TecNiqInc.com">www.TecNiqInc.com</a> for a complete part list) | Amp Draw      | Color | Pack |
|------------|---|---------------|-------|------|
| D17-30S0-1 | Surface Mount RGB Accent Light  | Varies        |       | 30   |
| D17-A0S0-1 | Surface Mount Amber Accent Light  |               |       | 30   |
| D17-WB00-1 | Porch/Accent Light Black  | 0.21A - 0.29A |       | 30   |
| D17-WS00-1 | Porch/Accent Light with Stainless Cover   |               |       | 30   |



# D21 – Link-Light

- 80 lumens of output per section
- Perfect choice for rub rails, area/ accent lighting, or deck lighting with high moisture exposure
- Can be installed with adhesive tape or mechanical fasteners

**• WIRE COLORS**

**Black** - Ground, **Red** - Positive



\* Link feature at each end of light allows for easy connection

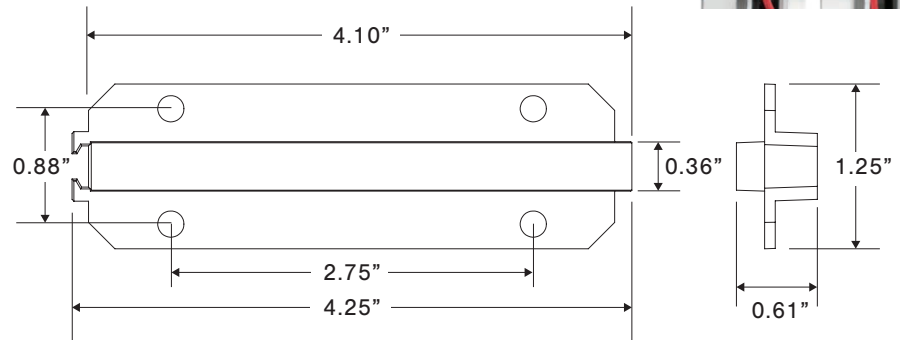

| Part No.   | Part Description (Please see Index, or <a href="http://www.TecNiqInc.com">www.TecNiqInc.com</a> for a complete part list) | Amp Draw        | Color | Pack |
|------------|---|-----------------|-------|------|
| D21-AC00-1 | Emergency Accessory Light Amber   | 0.155A - 0.215A |       | 50   |
| D21-RC00-1 | Emergency Accessory Light Red   |                 |       | 50   |
| D21-BC00-1 | Emergency Accessory Light Blue  |                 |       | 50   |
| D21-GC00-1 | Emergency Accessory Light Green   | 0.145A - 0.205A |       | 50   |

Area/Accent Lighting



## E02 – Miniature Accent Lights



- Durable and dependable design built to last and provide a lifetime of area/accent lighting to walkways, steps and more
- Requires only a 5/8" hole and (2) #8 screws for installation
- Excellent UV and impact resistant polycarbonate
- Provides 90° light projection - available with or without black cover

• **WIRE COLORS**  
**White** - Ground, **Black** - Positive

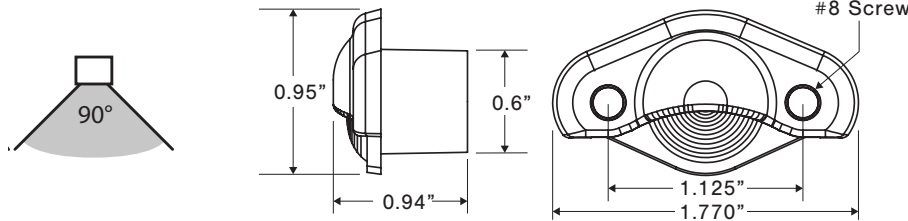

| Part No.   | Part Description (Please see Index, or <a href="http://www.TecNiqInc.com">www.TecNiqInc.com</a> for a complete part list) | Amp Draw    | Color | Pack |
|------------|---|-------------|-------|------|
| E02-B000-1 | Miniature Accent Light, Blue, Clear Lens  | 0.02A-0.03A |       | 100  |
| E02-G000-1 | Miniature Accent Light, Green, Clear Lens   | 0.02A-0.03A |       | 100  |
| E02-R000-1 | Miniature Accent Light, Red Clear Lens  | 0.05A-0.07A |       | 100  |
| E02-W000-1 | Miniature Accent Light, White, Clear Lens   | 0.06A-0.08A |       | 100  |

Area/Accent Lighting



## E03 – Linear Eon Lights



- 316 stainless steel covers available in horizontal or vertical mount options (covers required for surface mount)
- Easily install with (2) #6 screws
- White model provides 150 lumens
- Covers also available in black or white powder coat



\* Vertical Mount



\* Horizontal Mount



• **WIRE COLORS**  
**White** - Ground,  
**Color (LED color)** - Positive

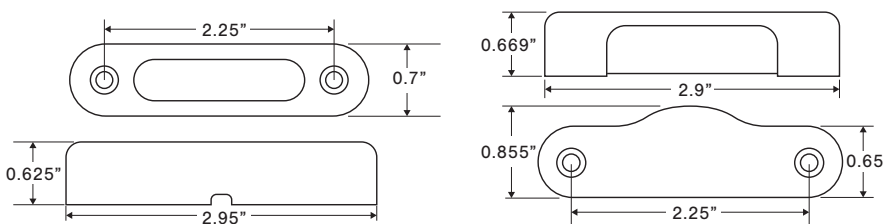

| Part No.   | Part Description (Please see Index, or <a href="http://www.TecNiqInc.com">www.TecNiqInc.com</a> for a complete part list) | Amp Draw    | Color | Pack |
|------------|---|-------------|-------|------|
| E03-D001-1 | Eon Light Linear Body, Deep Red, 36 in Wire   | 0.08A-0.12A |       | 50   |
| E03-B001-1 | Eon Light Linear Body, Blue, 36 in Wire   | 0.09A-0.13A |       | 50   |
| E03-G001-1 | Eon Light Linear Body, Green, 36 in Wire  | 0.09A-0.13A |       | 50   |
| E03-L000-1 | Eon Light Linear Body, Neutral White, 8 in Wire   | 0.08A-0.12A |       | 50   |





## E05 – Surface Mount Area Light

- Integrated push button On/Off switch
- Available with 316 stainless steel or high-impact molded covers in white or black
- Vibration proof and great appearance - with 220 lumens of output
- Can be mounted flat or on 1" round surface with available Bar Adapter



\* 1" Round Bar Adapter

### • WIRE COLORS

**Black** - Ground, **White** - Positive



\*Fasteners are hidden

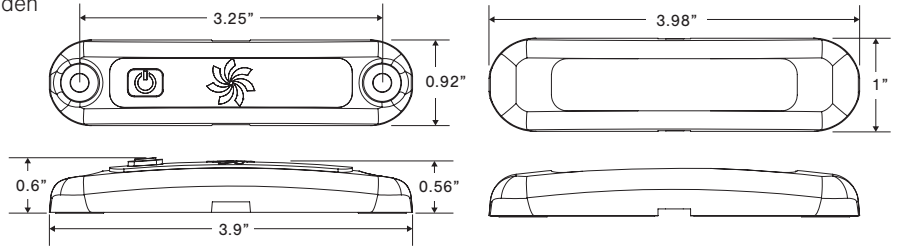

| Part No.   | Part Description (Please see Index, or <a href="http://www.TecNiqInc.com">www.TecNiqInc.com</a> for a complete part list) | Amp Draw    | Color  | Pack |
|------------|---|-------------|--|------|
| E05-0B00-1 | Interior Area Light - 1" Round Bar Mt. Adapter  |             |  | 10   |
| E05-WBS0-1 | Interior Area Light Surface Mt.White LED Black Cover  |             | <input type="checkbox"/> <input type="radio"/> | 10   |
| E05-WSS0-1 | Interior Area Light Surface Mt, White LED SS Cover  | 0.13A-0.18A | <input type="checkbox"/> <input type="radio"/> | 10   |
| E05-WWS0-1 | Interior Area Light, Surface Mt. White Cover  |             | <input type="checkbox"/> <input type="radio"/> | 10   |



## E06 – 4" - Silho-X Area Light



- Shock proof, moisture resistant design providing 380 lumens
- Quickly mounts using (2) #6 screws under then lens
- Available with stainless steel, black or white trim rings
- Available in Red/White



\* Combination White/Red Option



\* Black & White Trim Models

### • WIRE COLORS

**Black** - Ground,  
**White** - Positive  
**Red (red/white)** - Red LEDs

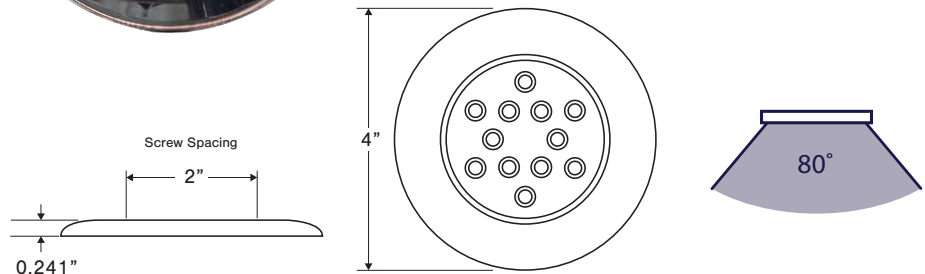

| Part No.   | Part Description (Please see Index, or <a href="http://www.TecNiqInc.com">www.TecNiqInc.com</a> for a complete part list) | Amp Draw    | Color   | Pack |
|------------|---|-------------|---|------|
| E06-3S00-1 | Silho-X 4" Round RGB Light SS Trim Ring   | Varies      | <input checked="" type="checkbox"/> <input type="checkbox"/> <input type="checkbox"/> | 10   |
| E06-LS00-1 | Silho-X 4" Round Neutral White Light SS Trim Ring   |             | <input type="checkbox"/> <input type="radio"/>  | 10   |
| E06-MS00-1 | Silho-X 4" Round Warm White Light SS Trim Ring  | 0.22A-0.26A | <input type="checkbox"/> <input type="radio"/>  | 10   |
| E06-WS00-1 | Silho-X 4" Round White Light SS Trim Ring   |             | <input type="checkbox"/> <input type="radio"/>  | 10   |



# E11 – 1.5” - Silho-X Area Light



- Shock proof, moisture resistant design providing 40 lumens
- Mounts using (2) #4 flat-head screws under then lens
- Available with stainless steel, black or white trim rings
- Performance over 50,000 hours

• **WIRE COLORS**  
**Black** - Ground,  
**White** - Positive

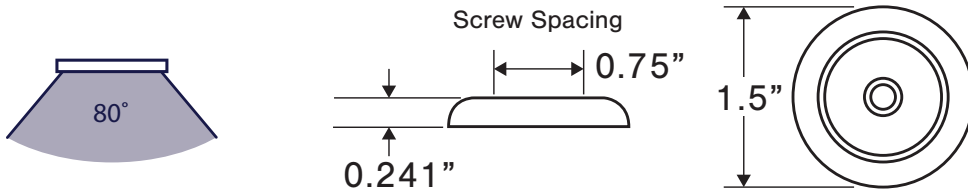

| Part No.   | Part Description (Please see Index, or <a href="http://www.TecNiqInc.com">www.TecNiqInc.com</a> for a complete part list) | Amp Draw    | Color   | Pack |
|------------|---|-------------|---|------|
| E11-LS00-1 | Silho-X 1.5" Round <b>Neutral White</b> light SS Trim Ring  |             | <input type="checkbox"/> <input type="radio"/>            | 10   |
| E11-MS00-1 | Silho-X 1.5" Round Warm White Light SS Trim Ring  | 0.07A-0.09A | <input type="checkbox"/> <input type="radio"/>            | 10   |
| E11-WS00-1 | Silho-X 1.5" Round White Light SS Trim Ring   |             | <input type="checkbox"/> <input type="radio"/>            | 10   |
| E11-BS01-1 | Silho-X 1.5" Round Blue Light SS Trim Ring  | 0.09A-0.12A | <input checked="" type="checkbox"/> <input type="radio"/> | 10   |

Area/Accent Lighting



# E13 – 2.75” - Silho-X Area/Accent Lights



- Shock proof, moisture resistant design
- Mounts using (2) #4 flat-head screws under then lens
- Available with stainless steel, black or white trim rings
- Performance over 50,000 hours

• **Available in RGB**

• **WIRE COLORS**  
**Black** - Ground,  
**White** - Positive  
**Red (red/white)** - Red LEDs

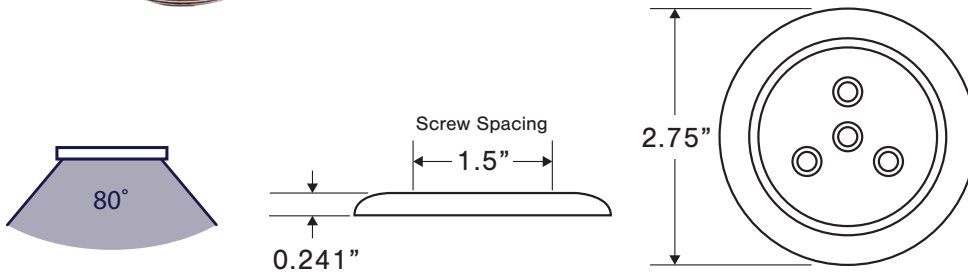

| Part No.   | Part Description (Please see Index, or <a href="http://www.TecNiqInc.com">www.TecNiqInc.com</a> for a complete part list) | Amp Draw    | Color   | Pack |
|------------|---|-------------|---|------|
| E13-3S00-1 | Silho-X 2.75" Round RGB Light SS Trim Ring  | Varies      | <input checked="" type="checkbox"/> <input type="radio"/> | 20   |
| E13-AB10-1 | Silho-X 2.75" Round LP Amber Light - Black Trim Ring  | 0.03A-0.05A | <input checked="" type="checkbox"/> <input type="radio"/> | 20   |
| E13-BB10-1 | Silho-X 2.75" Round LP Blue Light - Black Trim Ring   |             | <input checked="" type="checkbox"/> <input type="radio"/> | 20   |
| E13-GB10-1 | Silho-X 2.75" Round LP Green Light - Black Trim Ring  | 0.02A-0.03A | <input checked="" type="checkbox"/> <input type="radio"/> | 20   |



## E34 – Grommet Mount Step/Accent Lights

- Provides downward accent light perfect for walkways, steps and more
- Easily mounts into 3/4" hole
- Includes a chemical resistant TPE grommet
- Available with chrome or black cover



- **WIRE COLORS**  
**Black** - Ground,  
**White** - Positive

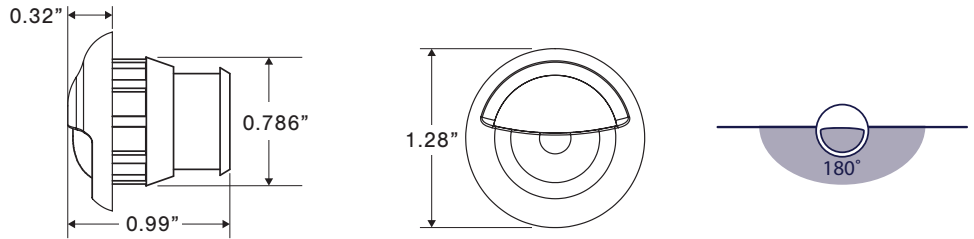

| Part No.   | Part Description (Please see Index, or <a href="http://www.TecNiqInc.com">www.TecNiqInc.com</a> for a complete part list) | Amp Draw      | Color | Pack |
|------------|---|---------------|-------|------|
| E34-BB00-1 | Blue Step Accent Light Black Cover  | 0.02A - 0.04A |       | 100  |
| E34-BC00-1 | Blue Step Accent Light Chrome Cover   |               |       | 100  |
| E34-RB00-1 | Red Step Accent Light Black Cover   | 0.06A - 0.08A |       | 100  |
| E34-RC00-1 | Red Step Accent Light Chrome Cover  |               |       | 100  |



## M90 – Hardware Free Accent Lights

- Completely water proof light, perfect for illuminating steps, walk ways, or livewells
- Easy installation with threaded nylon nut
- Includes (2) chemical resistant TPE gaskets
- Performance over 50,000 hours



\* Also available as a Livewell light with no cover



- **WIRE COLORS**  
**Black** - Ground, **White** - Positive

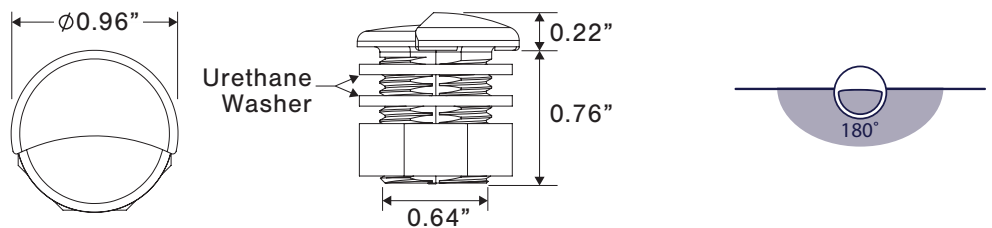

| Part No.   | Part Description (Please see Index, or <a href="http://www.TecNiqInc.com">www.TecNiqInc.com</a> for a complete part list) | Amp Draw    | Color | Pack |
|------------|---|-------------|-------|------|
| M90-BS00-1 | Interior Accent Light, Blue LED, SS Cover   | 0.02A-0.03A |       | 50   |
| M90-GS00-1 | Interior Accent Light, Green LED, SS Cover  |             |       | 50   |
| M90-RS00-1 | Interior Accent Light, Red LED, SS Cover  | 0.05A-0.07A |       | 50   |
| M90-WS00-1 | Interior Accent Light, White LED, SS Cover  |             |       | 50   |





## E07 – 8” Recessed Medical Vehicle Interior Light

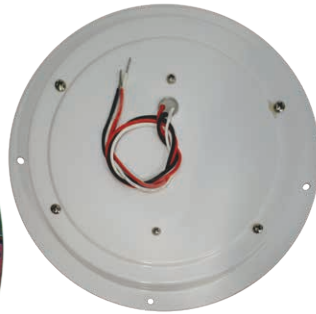
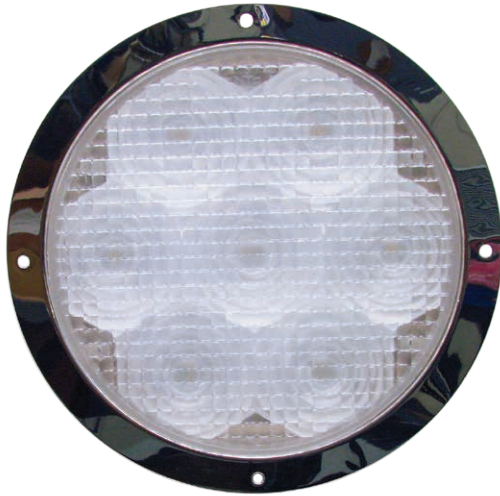

- Shock proof & moisture resistant
- **Exceeds Triple K** requirements
- Produces 840 lumens
- High quality LEDs keep color over the life of the lamp
- MRI compatible models available

- **WIRE COLORS**  
**Black** - Ground,  
**White** - Low Intensity,  
**Red** - High Intensity

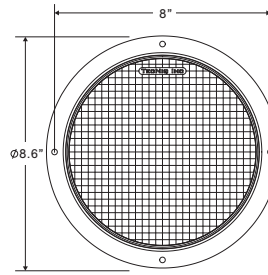
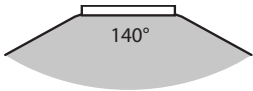

| Part No.   | Part Description (Please see Index, or <a href="http://www.TecNiqInc.com">www.TecNiqInc.com</a> for a complete part list) | Amp Draw           | Color   | Pack |
|------------|---|--------------------|---|------|
| E08-LC00-1 | 8" EV White Interior Light Chrome Trim - 31 LED's   | 1.12A - 1.52A      | <input type="checkbox"/> <input type="radio"/>            | 10   |
| E08-LCR0-1 | 8" EV White Red Interior Light Chrome Trim  | 0.86A / 0.4A (red) | <input checked="" type="checkbox"/> <input type="radio"/> | 10   |
| E08-WC00-1 | 8" EV White Interior Light Chrome Trim - 31 LED's   | 1.12A - 1.52A      | <input type="checkbox"/> <input type="radio"/>            | 10   |
| E08-WCR0-1 | 8" EV White Red Interior Light Chrome Trim  | 0.86A / 0.4A (red) | <input checked="" type="checkbox"/> <input type="radio"/> | 10   |

Dome & Interior Lighting



## E08 – 8” Recessed Medical Vehicle Interior Light

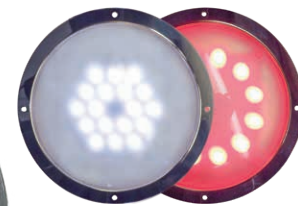

\* Combination White/Red Option

- Shock proof & moisture resistant
- **NFPA** and **Triple K** compliant
- **1000** (18 LED) or **1500** (31 LED) lumens illuminate a wide area
- AccuColor LEDs provide more natural skin tones
- MRI compatible models available

- **WIRE COLORS**  
**Black** - Ground,  
**White** - Low Intensity,  
**Yellow** - High Intensity,  
**Red (red/white model)** - Red LEDs

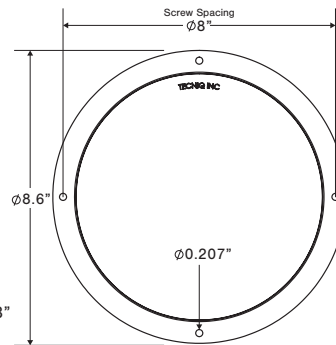
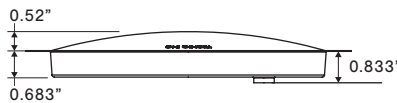
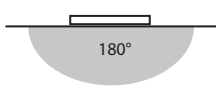

| Part No.   | Part Description (Additional part numbers available at <a href="http://www.TecNiqInc.com">www.TecNiqInc.com</a> ) | Amp Draw      | Color  | Pack |
|------------|---|---------------|--|------|
| E08-LC00-1 | 8" EV White Interior Light Chrome Trim - 31 LED's   | 1.12A - 1.52A | <input type="checkbox"/> <input type="radio"/> | 10   |
| E08-WW00-1 | 8" EV White Interior Light White Trim - 31 LED's  | 1.12A - 1.52A | <input type="checkbox"/> <input type="radio"/> | 10   |
| E08-LC10-1 | 8" EV White Interior Light Chrome Trim - 18 LED's 8 EV  | 0.57A - 0.86A | <input type="checkbox"/> <input type="radio"/> | 10   |
| E08-WW10-1 | 8" EV White Interior Light White Trim - 18 LED's  | 0.57A - 0.86A | <input type="checkbox"/> <input type="radio"/> | 10   |



## E12 – Red/White Dome Light

- Shock proof & moisture resistant
- Auto Hi/Lo feature connects to door
- Quickly mounts using (2) #4 screws under lens
- Performance over 50,000 hours

### • WIRE COLORS

- Black** - Ground, **Red** - Positive,
- Green** - Red/White Indicator,
- White** - White Door Switch Input (12V or Ground),
- Blue** - Red Door Switch (12V or Ground)

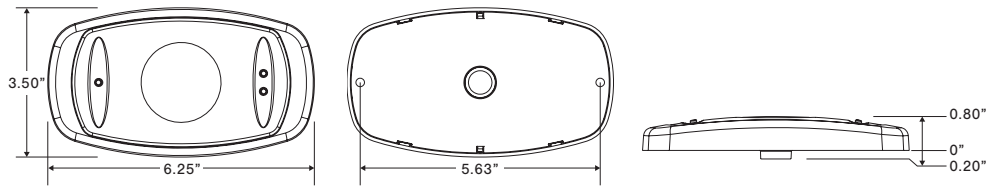

| Part No.    | Part Description (Additional part numbers available at www.TecNiqInc.com) | Amp Draw               | Color  | Pack |
|-------------|---|------------------------|--|------|
| E12-WB0R-1  | White Red Combo Dome Light w/ 3P Conn                                     | 0.36A/0.07A - High/Low | <input type="checkbox"/> <input type="radio"/> | 36   |
| E12-WB0RP-1 | White Red Combo Dome Light w/ Pigtaills                                   | 0.09A - Red            | <input type="checkbox"/> <input type="radio"/> | 36   |

Dome & Interior Lighting



## E16 – High Output Dome Light

- Lamp features (6) high efficiency LEDs, providing over 300 lumens
- Sleek and stylish surface mount design
- Available with or without integrated On/Off switch
- Installs with just (4) screws hidden behind lens



### • WIRE COLORS

- Black** - Ground, **White** - Positive

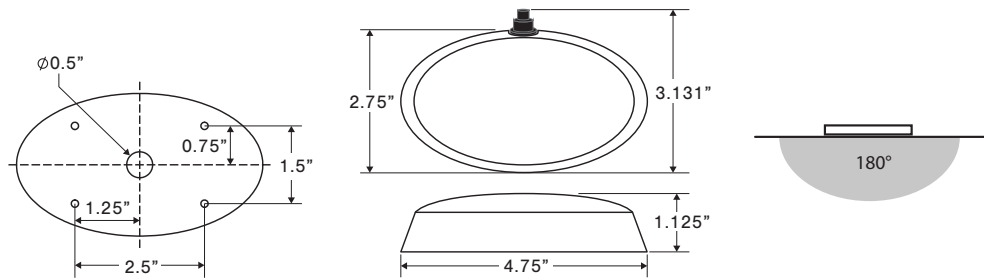

| Part No.   | Part Description (Additional part numbers available at www.TecNiqInc.com) | Amp Draw      | Color  | Pack |
|------------|---|---------------|--|------|
| E16-LB00-1 | E16 Interior SM Neutral White Oval Light Black Base                       | 0.18A - 0.23A | <input type="checkbox"/> <input type="radio"/> | 20   |
| E16-LW00-1 | E16 Interior SM Neutral White Oval Light White Base                       |               | <input type="checkbox"/> <input type="radio"/> | 20   |
| E16-MW00-1 | E16 Interior SM Warm White Oval Light White Base                          |               | <input type="checkbox"/> <input type="radio"/> | 20   |
| E16-WWS0-1 | E16 Interior SM White Oval Light White Base w/Switch                      |               | <input type="checkbox"/> <input type="radio"/> | 20   |



## E18 – High Output Utility Light



- Surface mounted for ease of installation, requiring (1) 3/8" hole
- Vibration & moisture resistant
- Available with or without integrated On/Off switch
- Lamp output of 800 lumens
- Made with high grade polycarbonate for excellent optics and impact resistant

**• WIRE COLORS**

**White** - Ground, **Black** - Positive

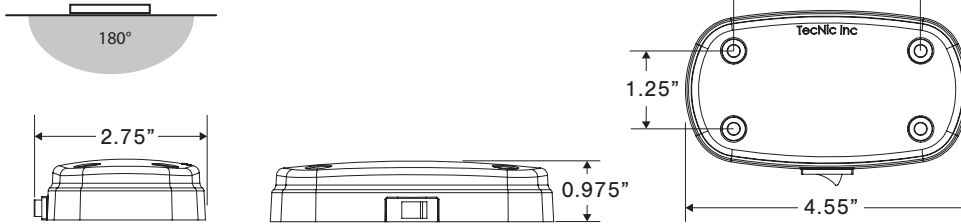

| Part No.   | Part Description (Please see Index, or <a href="http://www.TecNiqInc.com">www.TecNiqInc.com</a> for a complete part list) | Amp Draw    | Color  | Pack |
|------------|---|-------------|--|------|
| E18-LC00-1 | 12 LED Neutral White Dome Light   | 0.54A-0.66A | <input type="checkbox"/> <input type="radio"/> | 10   |
| E18-LCS0-1 | 12 LED Neutral White Dome Light with Switch   |             | <input type="checkbox"/> <input type="radio"/> | 10   |
| E18-WC00-1 | 12 LED White Dome Light   |             | <input type="checkbox"/> <input type="radio"/> | 10   |
| E18-WCS0-1 | 12 LED White Dome Light with switch   |             | <input type="checkbox"/> <input type="radio"/> | 10   |

Dome & Interior Lighting



## E20 – 6" - Orion Surface Mount Dome Light



\*Combination White/Red Option

- Ultra thin surface mount light
- Moisture resistant design
- Available in bright or satin finish
- Night Vision – Red/White LED combination also available

**• WIRE COLORS**

**Black** - Ground, **White** - Positive, **Red (red/white model)** - Red LEDs

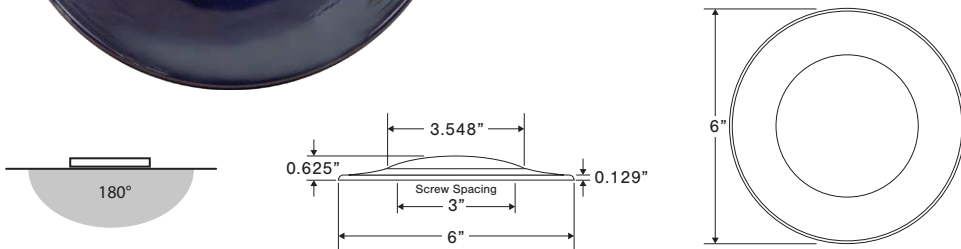

| Part No.   | Part Description (Please see Index, or <a href="http://www.TecNiqInc.com">www.TecNiqInc.com</a> for a complete part list) | Amp Draw    | Color  | Pack |
|------------|---|-------------|--|------|
| E20-LA00-1 | 6" Interior Light Neutral White Aluminum Trim Ring  | 0.48A-0.59A | <input type="checkbox"/> <input type="radio"/> | 5    |
| E20-LC00-1 | 6" Interior Light Neutral White Chrome Trim Ring  |             | <input type="checkbox"/> <input type="radio"/> | 5    |
| E20-MA00-1 | 6" Interior Light Warm White Aluminum Trim Ring   |             | <input type="checkbox"/> <input type="radio"/> | 5    |
| E20-MC00-1 | 6" Interior Light Warm White Chrome Trim Ring   |             | <input type="checkbox"/> <input type="radio"/> | 5    |





## E25 – 3” - Spring Mount Dome Light

- Moisture resistant and vibration proof
- 150 lumens of output
- Features diffused lens
- Available with or without On/Off push button switch
- Spring clips provide easy install
- Performance over 50,000 hours

**• WIRE COLORS**

**White** - Ground, **Black** - Positive

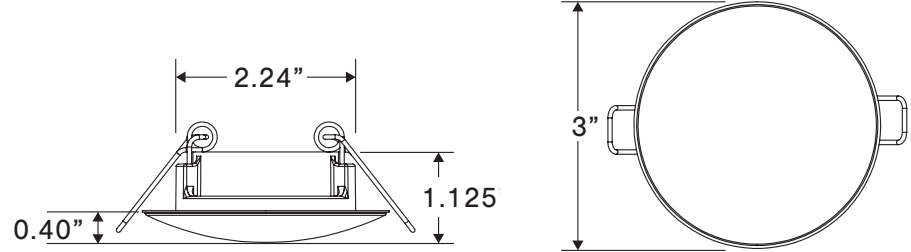

| Part No.   | Part Description (Please see Index, or <a href="http://www.TecNiqInc.com">www.TecNiqInc.com</a> for a complete part list) | Amp Draw    | Color  | Pack |
|------------|---|-------------|--|------|
| E25-L000-1 | 3in Spring Mounted Dome Light Neutral White   |             | <input type="checkbox"/> <input type="radio"/> | 10   |
| E25-M000-1 | 3in Spring Mounted Dome Light Warm White  | 0.13A-0.15A | <input type="checkbox"/> <input type="radio"/> | 10   |
| E25-W000-1 | 3in Spring Mounted Dome Light Cool White  |             | <input type="checkbox"/> <input type="radio"/> | 10   |



## E26 – 4.5” - Spring Mount Dome Light

- Moisture resistant and vibration proof
- 300 Lumens (4.5” model)  
460 Lumens (4.5” premium model)
- Available with or without integrated On/Off switch
- Spring clips provide easy installation

**• WIRE COLORS**

**White** - Ground, **Black** - Positive

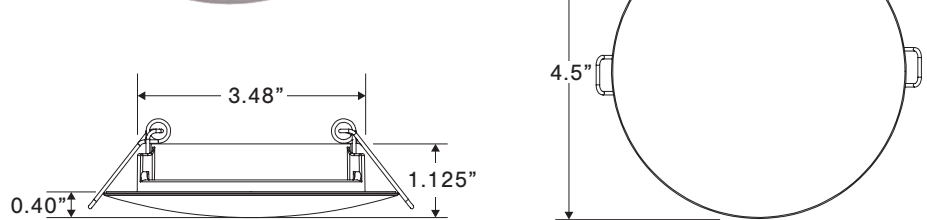

| Part No.   | Part Description (Please see Index, or <a href="http://www.TecNiqInc.com">www.TecNiqInc.com</a> for a complete part list) | Amp Draw    | Color  | Pack |
|------------|---|-------------|--|------|
| E26-L000-1 | 4.5in Spring Mounted Dome Light Neutral White   |             | <input type="checkbox"/> <input type="radio"/> | 10   |
| E26-M000-1 | 4.5in Spring Mounted Dome Light Warm White  | 0.25A-0.31A | <input type="checkbox"/> <input type="radio"/> | 10   |
| E26-W000-1 | 4.5in Spring Mounted Dome Light Cool White  |             | <input type="checkbox"/> <input type="radio"/> | 10   |
| E26-LP00-1 | 4.5 in Spring Mounted Premium Dome Light Neutral White  | 0.38A-0.46A | <input type="checkbox"/> <input type="radio"/> | 10   |



## E27 – 3” - Surface Mount Dome Light

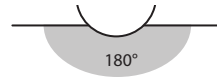

- Bright **175 lumens** of output
- Surface mounted for easy installation (3/8” wire hole)
- Performance over 50,000 hours
- 4.5” Premium model available
- Three mounting screws are concealed by the trim ring

• **WIRE COLORS**

**White** - Ground, **Black** - Positive

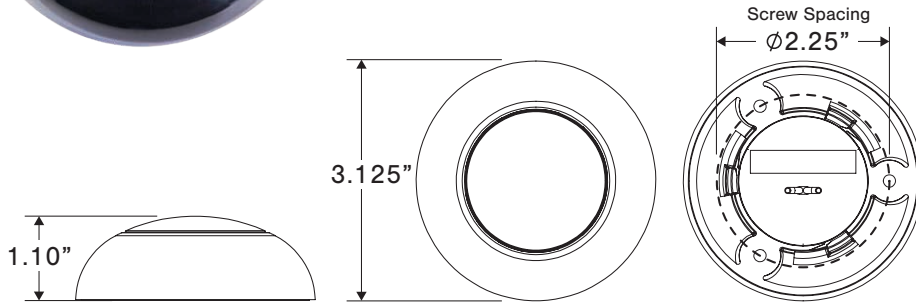

| Part No.   | Part Description (Please see Index, or <a href="http://www.TecNiqInc.com">www.TecNiqInc.com</a> for a complete part list) | Amp Draw      | Color  | Pack |
|------------|---|---------------|--|------|
| E27-L000-1 | 3" Surface Mounted Dome Light Neutral White   | 0.13A - 0.15A | <input type="checkbox"/> <input type="radio"/> | 10   |
| E27-M000-1 | 3" Surface Mounted Dome Light Warm White  |               | <input type="checkbox"/> <input type="radio"/> | 10   |
| E27-W000-1 | 3" Surface Mounted Dome Light Cool White  |               | <input type="checkbox"/> <input type="radio"/> | 10   |

Dome & Interior Lighting



## E28 – 4.5” - Surface Mount Dome Light

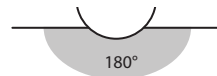

- Bright **350 lumens** of output
- Surface mounted for easy installation (3/8” wire hole)
- Performance over 50,000 hours
- Available with On/Off switch
- 4.5” Premium model available (525 lumens)

• **WIRE COLORS**

**White** - Ground, **Black** - Positive

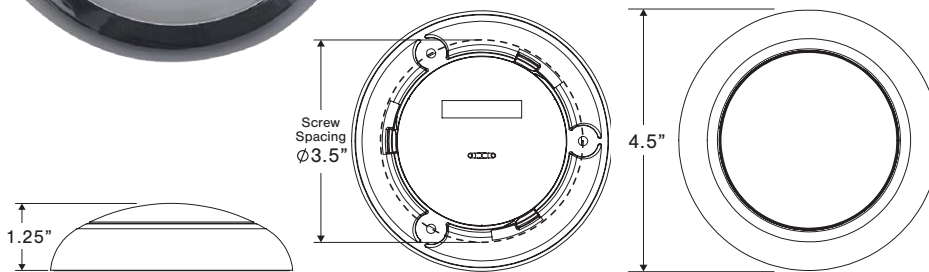

| Part No.   | Part Description (Please see Index, or <a href="http://www.TecNiqInc.com">www.TecNiqInc.com</a> for a complete part list) | Amp Draw      | Color  | Pack |
|------------|---|---------------|--|------|
| E28-L000-1 | 4.5" Surface Mounted Dome Light Neutral White   | 0.25A - 0.31A | <input type="checkbox"/> <input type="radio"/> | 10   |
| E28-M000-1 | 4.5" Surface Mounted Dome Light Warm White  |               | <input type="checkbox"/> <input type="radio"/> | 10   |
| E28-W000-1 | 4.5" Surface Mounted Dome Light Cool White  |               | <input type="checkbox"/> <input type="radio"/> | 10   |
| E28-WPS0-1 | 4.5" Surface Mounted Premium Dome Light Cool White w/ Switc   | 0.38A - 0.46A | <input type="checkbox"/> <input type="radio"/> | 10   |



## E30 – High Performance Ceiling Light

- Available in 1050 lumens (21 LED model) or 2100 lumens (42 LED model)
- Excellent replacement for fluorescent light fixtures
- NFPA and Triple K compliant
- Hi/Low output optional
- Moisture resistant and vibration proof design



\* Red/White Combo Model

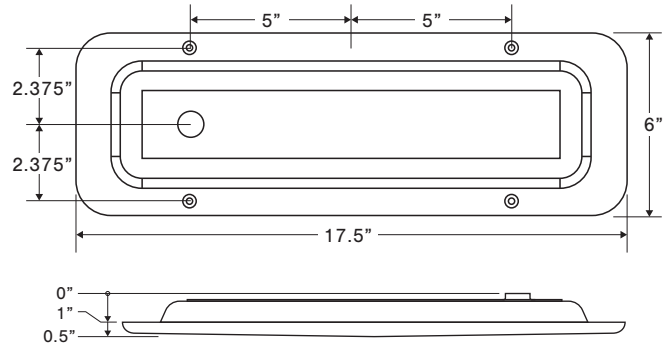

**• WIRE COLORS**

- Black** - Ground,
- White** - Low Intensity,
- Yellow** - High Intensity,
- Red (red/white model)** - Red LEDs



| Part No.   | Part Description (Please see Index, or <a href="http://www.TecNiqInc.com">www.TecNiqInc.com</a> for a complete part list) | Amp Draw    | Color  | Pack |
|------------|---|-------------|--|------|
| E30-L000-1 | Recessed 4K White 42 LED Light 6"x17.5"   | 1.3A - 1.9A | <input type="checkbox"/> <input type="radio"/> | 12   |
| E30-L00M-1 | Recessed 4K White 42 LED Light 6"x17.5" w/Motion Detection  | 1.3A - 1.9A | <input type="checkbox"/> <input type="radio"/> | 12   |
| E30-L010-1 | Recessed 4K White 21 LED Light 6"x17.5"   | 0.7A - 0.9A | <input type="checkbox"/> <input type="radio"/> | 12   |
| E30-W0S0-1 | Recessed 5K White 42 LED Light 6"x17.5" Switched  | 1.3A - 1.9A | <input type="checkbox"/> <input type="radio"/> | 12   |



## E31 – High Performance Ceiling Light

- Available in a Standard or Motion Detecor model with 2100 lumens
- Excellent replacement for fluorescent light fixtures
- NFPA and Triple K compliant
- Hi/Low output optional
- Moisture resistant and vibration proof design

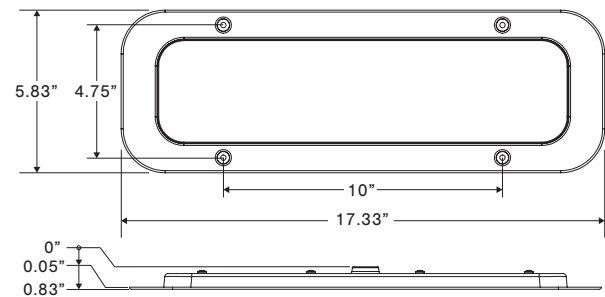
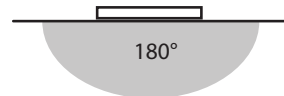

**• WIRE COLORS**

- White** - Ground,
- Black** - Positive



| Part No.   | Part Description (Please see Index, or <a href="http://www.TecNiqInc.com">www.TecNiqInc.com</a> for a complete part list) | Amp Draw      | Color  | Pack |
|------------|---|---------------|--|------|
| E31-L00B-1 | Recessed 4K White 32 LED Light 6"x17.5"   | 1.49A - 1.82A | <input type="checkbox"/> <input type="radio"/> | 12   |
| E31-L0MB-1 | Recessed 4K White 32 LED Light 6"x17.5" Motion Detection  | 1.49A - 1.82A | <input type="checkbox"/> <input type="radio"/> | 12   |
| E31-LOMS-1 | Recessed 4K White 32 LED Light 6"x17.5" Motion Detection w/ Spade Connector   | 1.49A - 1.82A | <input type="checkbox"/> <input type="radio"/> | 12   |





## E32 – Surface Mounted Interior Light

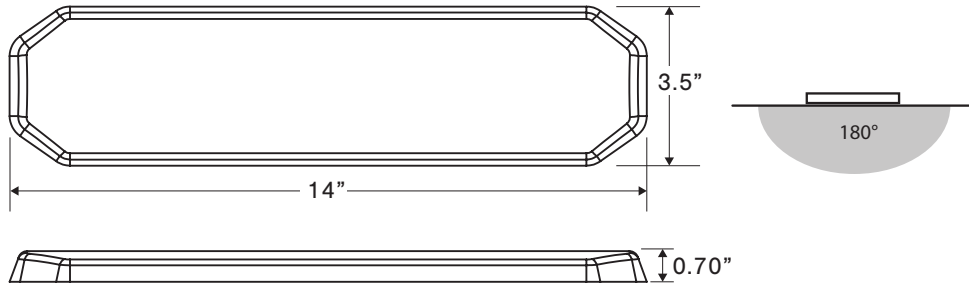

- Installs with just a 1/4" hole for the wire feed and (4) screws
- Lens cover snaps on to hide fasteners
- Available in a Standard, On/Off Button, or Motion Detector model
- Excellent replacement for fluorescent light fixtures
- NFPA and Triple K compliant
- Hi/Low output optional
- 2200 lumens in compact size

• **WIRE COLORS**  
**White** - Ground, **Black** - Positive



| Part No.   | Part Description (Please see Index, or <a href="http://www.TecNiqInc.com">www.TecNiqInc.com</a> for a complete part list) | Amp Draw      | Color  | Pack |
|------------|---|---------------|--|------|
| E32-L000-1 | Interior 4K White 42 LED Surface Mount Light  | 1.36A - 1.84A | <input type="checkbox"/> <input type="radio"/> | 10   |
| E32-L00M-1 | Interior 4K White 42 LED Surface Mount Light W/MD   |               | <input type="checkbox"/> <input type="radio"/> | 10   |
| E32-L00S-1 | Interior 4K White 42 LED Surface Mount Light W/Switch   |               | <input type="checkbox"/> <input type="radio"/> | 10   |

Dome & Interior Lighting



## E33 – Recessed Ceiling Light

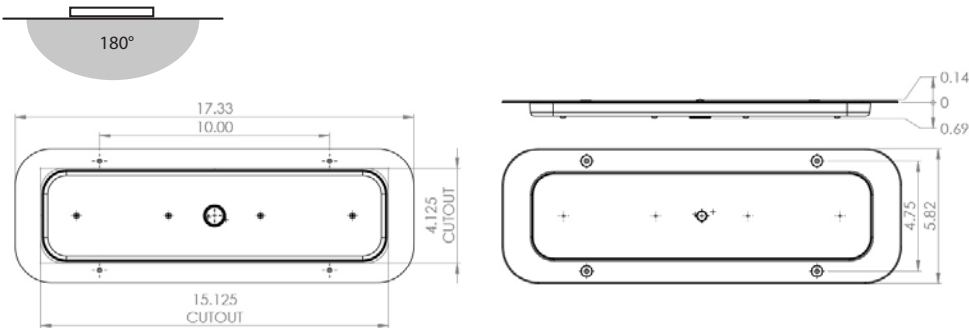

- New easy install design
- Available with a motion detection sensor
- Lighter, plastic housing is still NFPA & Triple K compliant without losing quality or performance
- Excellent replacement for fluorescent light fixtures

• **WIRE COLORS**  
**White** - Ground, **Black** - Positive



| Part No.   | Part Description (Please see Index, or <a href="http://www.TecNiqInc.com">www.TecNiqInc.com</a> for a complete part list) | Amp Draw      | Color  | Pack |
|------------|---|---------------|--|------|
| E33-L0MB-1 | Recessed 4K White 32 LED Light 6"x17.5" Motion Det w/180 Bullets Plastic Base   | 1.06A - 1.36A | <input type="checkbox"/> <input type="radio"/> | 12   |
| E33-L00B-1 | Recessed 4K White 32 LED Light 6"x17.5" w/180 Bullets Plastic Base  |               | <input type="checkbox"/> <input type="radio"/> | 12   |



## E50 – Round Surface Mount Dome Light

- Light features (12) high efficiency LEDs with 300 lumens of output
- Available with or without integrated On/Off switch
- Two mounting hole patterns hidden behind the lens
- Performance over 50,000 hours
- Stylish surface mount design

### • WIRE COLORS

**White** - Ground, **Black** - Positive

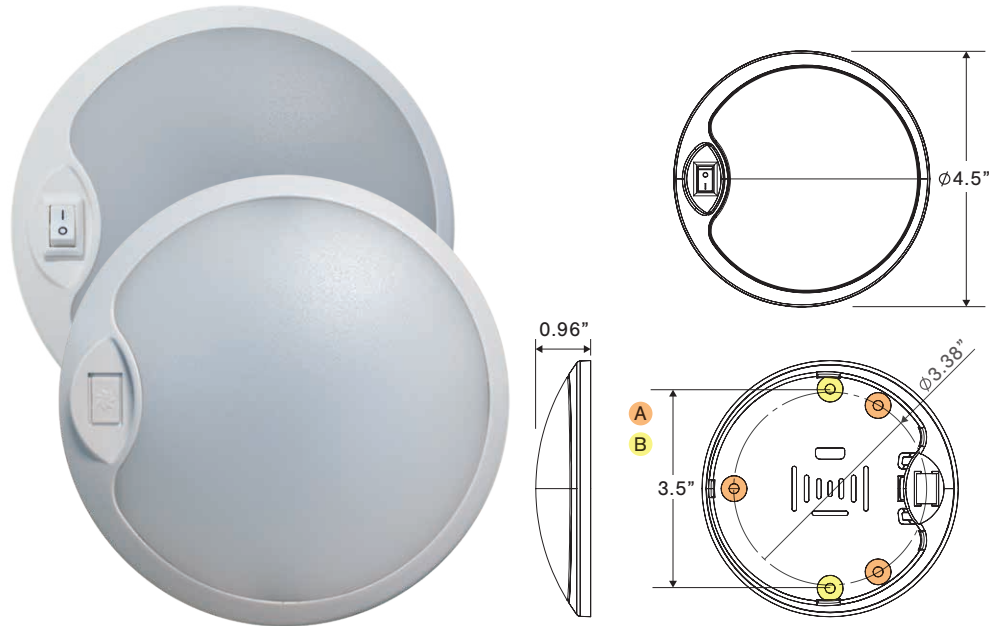

| Part No.   | Part Description (Please see Index, or <a href="http://www.TecNiqInc.com">www.TecNiqInc.com</a> for a complete part list) | Amp Draw      | Color   | Pack |
|------------|---|---------------|---|------|
| E50-MC00-1 | 4.5" Round Interior Lamp 12 LED No Switch   | 0.32A - 0.44A | <input type="checkbox"/> <input type="checkbox"/> | 20   |
| E50-MCS0-1 | 4.5" Round Interior Lamp 12 LED With Switch   |               | <input type="checkbox"/> <input type="checkbox"/> | 20   |
| E50-WC00-1 | 4.5" Round Interior Lamp 12 LED No Switch Cool LED  |               | <input type="checkbox"/> <input type="checkbox"/> | 20   |
| E50-WCS0-1 | 4.5" Round Interior Lamp 12 LED With Switch Cool LED  |               | <input type="checkbox"/> <input type="checkbox"/> | 20   |



## E51 – Oval Surface Mount Dome Light

- Light features (12) high efficiency LEDs with 300 lumens of output
- Available with or without integrated On/Off switch
- Two mounting hole patterns hidden behind the lens
- Performance over 50,000 hours
- Stylish surface mount design

### • WIRE COLORS

**White** - Ground, **Black** - Positive



| Part No.   | Part Description (Please see Index, or <a href="http://www.TecNiqInc.com">www.TecNiqInc.com</a> for a complete part list) | Amp Draw      | Color   | Pack |
|------------|---|---------------|---|------|
| E51-LC00-1 | 4.5" Round Interior Lamp 12 LED No Switch Neutral LED   | 0.32A - 0.44A | <input type="checkbox"/> <input type="checkbox"/> | 20   |
| E51-MC00-1 | 6" x 3.5" Oval Interior Lamp 12 LED No Switch   |               | <input type="checkbox"/> <input type="checkbox"/> | 20   |
| E51-WC00-1 | 6" x 3.5" Oval Interior Lamp 12 LED No Switch Cool LED  |               | <input type="checkbox"/> <input type="checkbox"/> | 20   |
| E51-WCS0-1 | 6" x 3.5" Oval Interior Lamp 12 LED With Switch Cool LED  |               | <input type="checkbox"/> <input type="checkbox"/> | 20   |



# T44 – 4” Round High Output Area Light

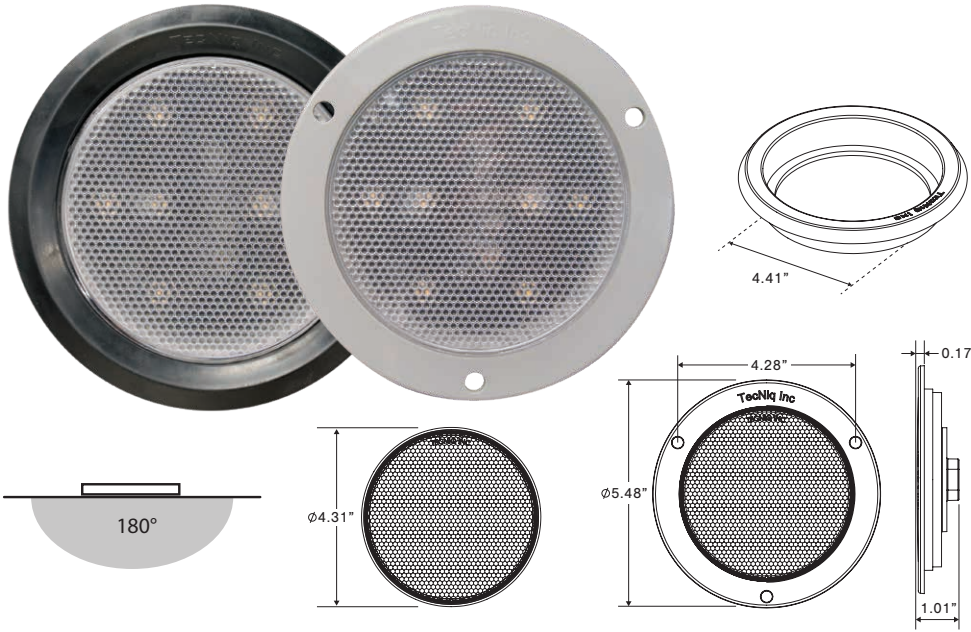

- Low amp draw: 0.25A @ 12V DC
- Guaranteed water proof, sealed body that is immune to shock and vibration
- Grommet or flange mount
- Performance over 50,000 hours

• **WIRE COLORS**  
**White** - Ground, **Black** - Positive



| Part No.   | Part Description (Please see Index, or <a href="http://www.TecNiqInc.com">www.TecNiqInc.com</a> for a complete part list) | Amp Draw    | Color  | Pack |
|------------|---|-------------|--|------|
| T44-WDOB-1 | 4" Round Dome Light 0.180 bullets   | 0.35A-0.48A | <input type="checkbox"/> <input type="radio"/> | 100  |
| T44-WDFB-1 | 4" Round Dome Light Flange Mount w/ 0.180 bullets   |             | <input type="checkbox"/> <input type="radio"/> | 100  |

Dome & Interior Lighting



# E35/36/38 – High Output Linear Area Light

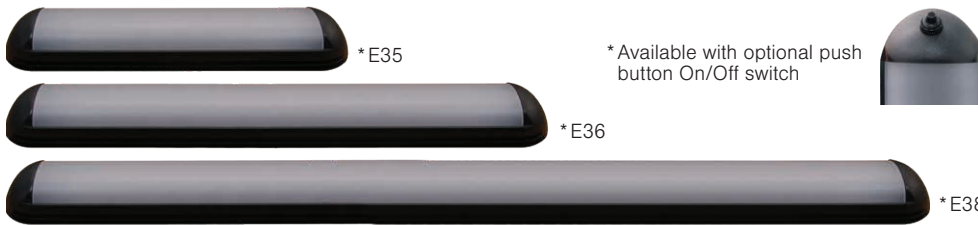

\*Available with optional push button On/Off switch

- Slim light design, perfect for under counter applications
- Shock proof and moisture resistant construction
- Easy replacement for fluorescent light fixtures
- 180° wide light illumination
- Quick and Easy mounting with (2) screws

• **WIRE COLORS**  
**White** - Ground, **Black** - Positive

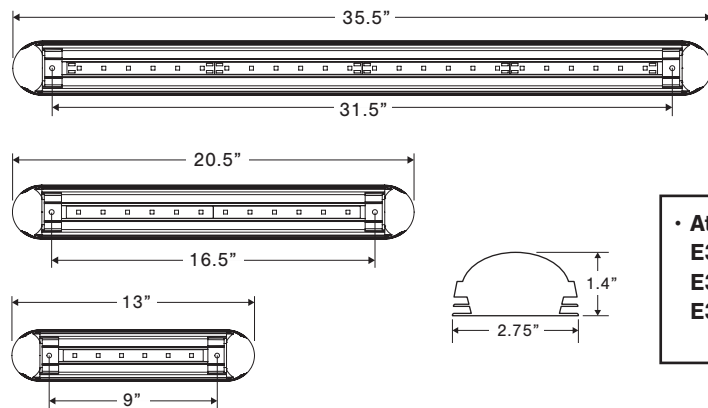

• **At 12V produces:**  
**E35** - 750 lumens (13")  
**E36** - 1500 lumens (20")  
**E38** - 3000 lumens (35")



| Part No.   | Part Description (Please see Index, or <a href="http://www.TecNiqInc.com">www.TecNiqInc.com</a> for a complete part list) | Amp Draw      | Color  | Pack |
|------------|---|---------------|--|------|
| E35-LB00-1 | Linear LED SM Light Neutral White Black Body 9W   | 0.47A - 0.58A | <input type="checkbox"/> <input type="radio"/> | 20   |
| E36-MB00-1 | Linear LED SM Light Warm White Black Body 18W   | 1.05A - 1.28A | <input type="checkbox"/> <input type="radio"/> | 20   |
| E38-WB00-1 | Linear LED SM Light White Black Body 36W  | 1.88A - 2.29A | <input type="checkbox"/> <input type="radio"/> | 10   |
| E38-WB0S-1 | Linear LED SM Light White Black Body 36W w/Switch   |               | <input type="checkbox"/> <input type="radio"/> | 10   |





## E41 – Flexible Strip Lighting (Black Back)

- Produces 150 lumens per section (white LEDs)
- Available in 4.5" increments, up to 16.5'
- Features **3M** tape for fast install

- **WIRE COLORS**  
**White** - Ground,  
**Black** - Positive



| Part No.   | Part Description (Please see Index, or <a href="http://www.TecNiqInc.com">www.TecNiqInc.com</a> for a complete part list) | Amp Draw    | Color   | Pack |
|------------|---|-------------|---|------|
| E41-W01V-1 | Flexible LED Light White 4.5" - 2 Wire  | 0.75A-0.91A | <input type="checkbox"/> <input type="radio"/>            | 25   |
| E41-B01V-1 | Flexible LED Light Blue 4.5" - 2 Wire   | 0.41A-0.50A | <input checked="" type="checkbox"/> <input type="radio"/> | 25   |



## E44 – Flexible Strip Lighting (White Back)



- Produces 150 lumens per 4.5" section (white LEDs)
- Available in 4.5" increments, up to 16.5'
- Features **3M** tape for fast install
- Ultra thin 1/2" strips mount easily in tight spaces

- **WIRE COLORS**  
**White** - Ground,  
**Black** - Positive

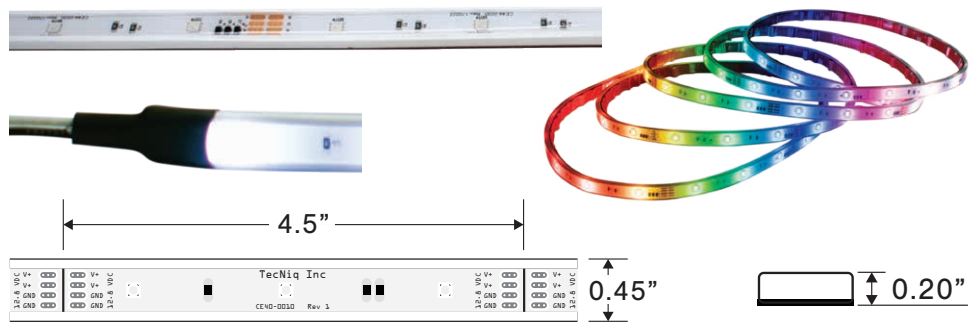

| Part No.   | Part Description (Please see Index, or <a href="http://www.TecNiqInc.com">www.TecNiqInc.com</a> for a complete part list) | Amp Draw    | Color   | Pack |
|------------|---|-------------|---|------|
| E41-B010-1 | Flexible LED Light Blue 4.5" - No Wire  | 0.16A-0.20A | <input checked="" type="checkbox"/> <input type="radio"/> | 25   |
| E41-G010-1 | Flexible LED Light Green 4.5" - No Wire   |             | <input checked="" type="checkbox"/> <input type="radio"/> | 25   |



## E45 – Flexible Strip Lighting (White Back)



- Available in multiple lengths
- 150 lumens per 4.5" standard, 300 lumens per 4.5" premium
- Mounts with (3) different style of clip choices

- **WIRE COLORS**  
**Black** - Ground,  
**White** - Positive



| Part No.    | Part Description (Please see Index, or <a href="http://www.TecNiqInc.com">www.TecNiqInc.com</a> for a complete part list) | Amp Draw | Color   | Pack |
|-------------|---|----------|---|------|
| E45-4B070-1 | 12.5" Aluminum Extrusion Lamp RGBW Black Housing  | variable | <input checked="" type="checkbox"/> <input type="radio"/> | 25   |
| E45-W050-1  | 15 LED 25" Aluminum Extrusion Lamp White Black Housing  | 0.40A    | <input checked="" type="checkbox"/> <input type="radio"/> | 25   |

Strip Lighting



# E46 – Water Resistant RGB+W Strip Light

**NEW PRODUCT**



- High flexibility conforms to irregular surfaces
- Easily installs with **3M**® tape back

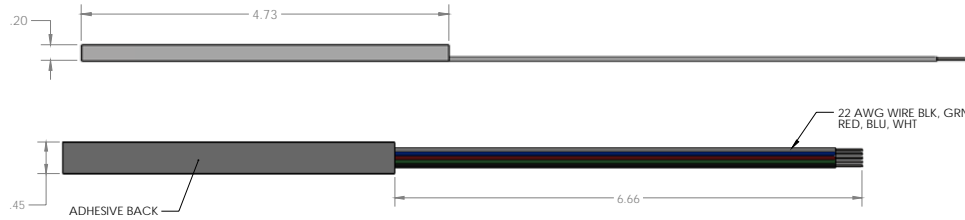

- **WIRE COLORS**  
**RGBW** - Ground, **Black** - Positive



| Part No.   | Part Description (Please see Index, or <a href="http://www.TecNiqInc.com">www.TecNiqInc.com</a> for a complete part list) | Amp Draw | Color | Pack |
|------------|---|----------|-------|------|
| E46-403V-1 | Water Resistant Flexible LED Light RGBW 6" with 5C wire   | Varies   |       | -    |
| E46-447V-1 | Water resistant Flexible LED Light RGBW 72" w/ 5C wire  |          |       | -    |

Strip Lighting



# E47 – Wide Body Diffused RGB Strip Light

**NEW PRODUCT**



- Sealed with end caps for superior protection
- Water resistant

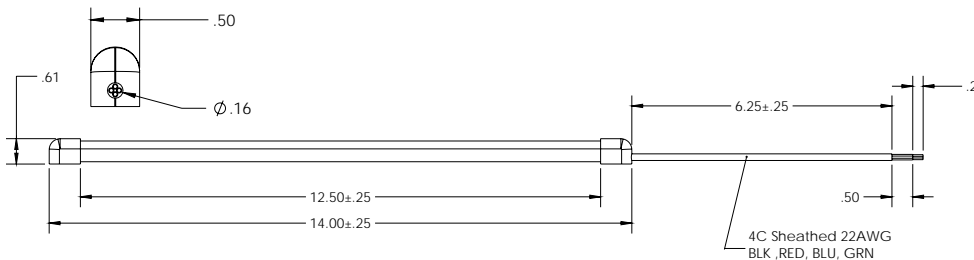

- **WIRE COLORS**  
**RGB** - Ground, **Black** - Positive



| Part No.    | Part Description (Please see Index, or <a href="http://www.TecNiqInc.com">www.TecNiqInc.com</a> for a complete part list) | Amp Draw | Color | Pack |
|-------------|---|----------|-------|------|
| E47-3D14V-1 | Wide Body Diffuse RGB Strip Light 14in w VHB  | Varies   |       | -    |
| E47-3D360-1 | Wide Body Diffuse RGB Strip Light 36in  |          |       | -    |



# E48 – Ultra Thin Diffused RGB Strip Light

**NEW PRODUCT**

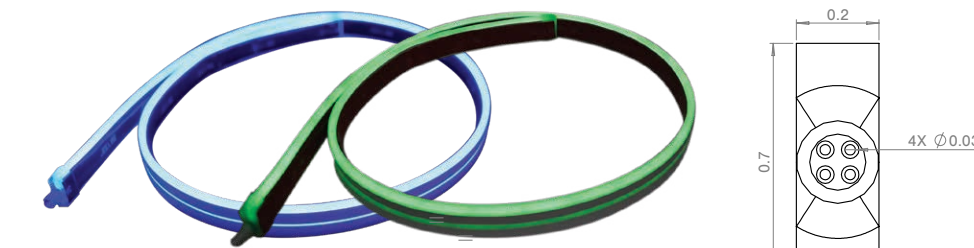

- Sealed with end caps for superior protection
- Water resistant

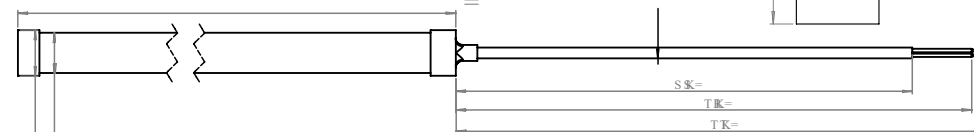

- **WIRE COLORS**  
**RGB** - Ground, **Black** - Positive



| Part No.    | Part Description (Please see Index, or <a href="http://www.TecNiqInc.com">www.TecNiqInc.com</a> for a complete part list) | Amp Draw | Color | Pack |
|-------------|---|----------|-------|------|
| E48-3D04L-1 | Ultra Thin Diffuse Strip Light 4in w LH Wire  | Varies   |       | -    |
| E48-3D04R-1 | Ultra Thin Diffuse Strip Light 4in w RH Wire  |          |       | -    |



## E49 – Slim Area/Accent Surface Mount Lights

- Frosted acrylic lens for even light distribution
- Available in 24", 36", and 48" models
- Performance over 100,000 hours
- Available in White/Blue & White

**• WIRE COLORS**

**White** - Ground, **Black** - Positive, **Blue** - Positive

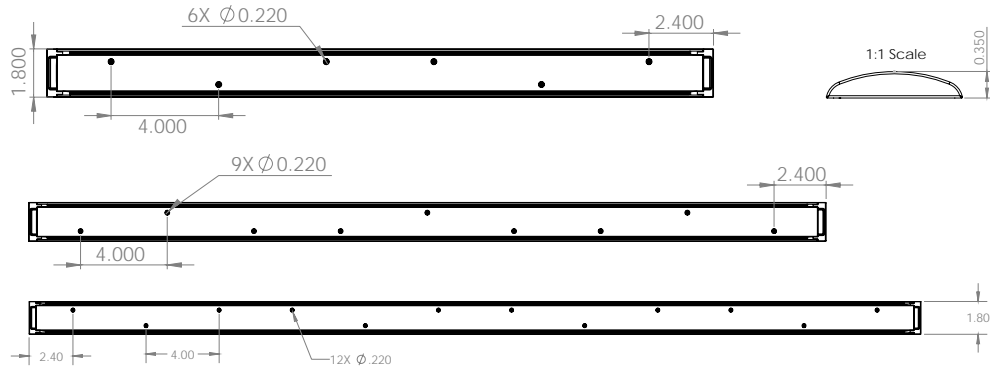

| Part No.    | Part Description (Please see Index, or <a href="http://www.TecNiqInc.com">www.TecNiqInc.com</a> for a complete part list) | Amp Draw                                  | Color  | Pack |
|-------------|---|---|--|------|
| E49-BWB20-1 | Blue White Rigid Black Alu Strip Light 24in   | 0.62A - 0.80A White<br>0.52A - 0.68A Blue | <input checked="" type="checkbox"/> <input type="checkbox"/> | -    |
| E49-BWB30-1 | Blue White Rigid Black Alu Strip Light 36in   |   | <input checked="" type="checkbox"/> <input type="checkbox"/> | -    |
| E49-BWB40-1 | Blue White Rigid Black Alu Strip Light 48in   |   | <input checked="" type="checkbox"/> <input type="checkbox"/> | -    |
| E49-WB20-1  | White Rigid Black Alu Strip Ligh 24"  | 0.62A - 0.80A                             | <input type="checkbox"/> <input type="checkbox"/>            | -    |

Strip Lighting



## E53 – Diffused Encased Strip Light

- An All NEW diffused and encased strip light with frosted lensing
- Light features high powered LEDs, providing a quality no glare lighting solution
- Available in 7", 13", or 25" lengths
- Provides 100,000 hours of performance
- Connects with 12" pigtail

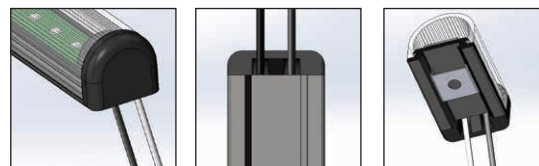

**• WIRE COLORS**

**Black** - Ground, **Red** - Positive,

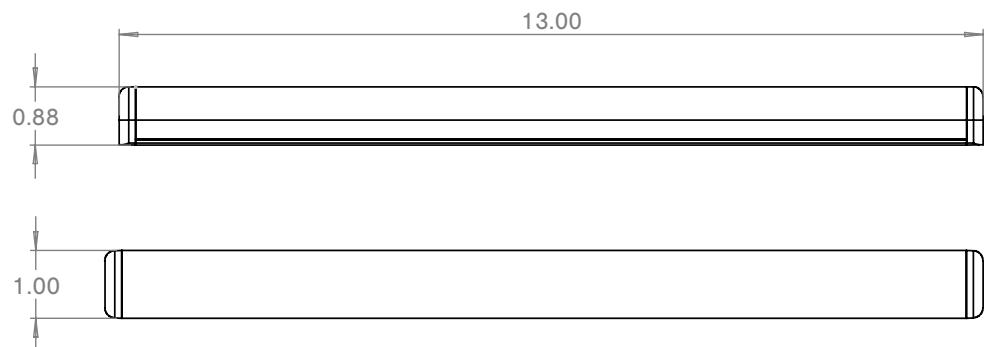

| Part No.     | Part Description (Please see Index, or <a href="http://www.TecNiqInc.com">www.TecNiqInc.com</a> for a complete part list) | Amp Draw        | Color   | Pack |
|--------------|---|-----------------|---|------|
| E53-WBE060-1 | 7" Diffused & Encased WHITE Interior Strip Light  | 0.165A - 0.225A | <input type="checkbox"/> <input type="checkbox"/> | -    |
| E53-WBE120-1 | 13" Diffused & Encased WHITE Interior Strip Light   |                 | <input type="checkbox"/> <input type="checkbox"/> | -    |
| E53-WBE240-1 | 25" Diffused & Encased WHITE Interior Strip Light   |                 | <input type="checkbox"/> <input type="checkbox"/> | -    |





# E57 – Wide Body RGB+W Strip Light

**NEW PRODUCT**



- Diffused strip light with great look and appearance
- Available in 6", 12", 33", or 68"
- Adhesive along the bottom provides easy application

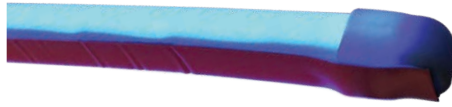

- **WIRE COLORS**  
**Black** - Positive,  
**RGB+W** - Ground

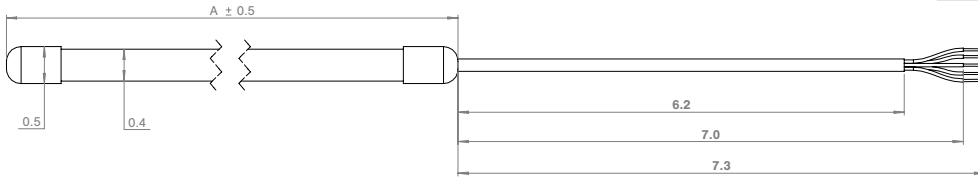
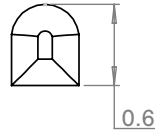

| Part No.    | Part Description (Please see Index, or <a href="http://www.TecNiqInc.com">www.TecNiqInc.com</a> for a complete part list) | Amp Draw  | Color | Pack  |
|-------------|---|---|-------|-------|
| E57-4D060-1 | Wide Body Diffuse RGBW Strip Light 6in  | Red .042A/ Green .031A/ Blue .029A/ White .032A |       | ○ TBD |
| E57-4D120-1 | Wide Body Diffuse RGBW Strip Light 12in   | Red .083A/ Green .061A/ Blue .057A/ White .063A |       | ○ TBD |
| E57-4D330-1 | Wide Body Diffuse RGBW Strip Light 33in   | Red .230A/ Green .170A/ Blue .158A/ White .175A |       | ○ TBD |
| E57-4D680-1 | Wide Body Diffuse RGBW Strip Light 68in   | Red .460A/ Green .340A/ Blue .316A/ White .350A |       | ○ TBD |

Strip Lighting



# E58 – Thin Diffused RGB+W Strip Light

**NEW PRODUCT**



- Diffused strip light with great look and appearance
- Available in 6", 12", 33", or 68"
- Great lighting to illuminate under cabinets, finished trim

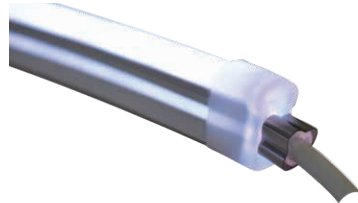

- **WIRE COLORS**  
**Black** - Positive,  
**RGB+W** - Ground

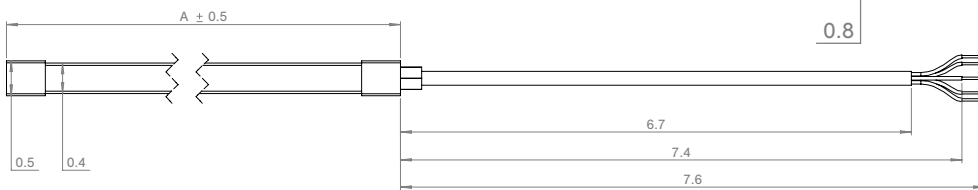
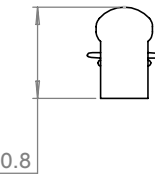

| Part No.    | Part Description (Please see Index, or <a href="http://www.TecNiqInc.com">www.TecNiqInc.com</a> for a complete part list) | Amp Draw  | Color | Pack  |
|-------------|---|---|-------|-------|
| E58-4D060-1 | Narrow Body Diffuse RGBW Strip Light 6in  | Red .042A/ Green .031A/ Blue .029A/ White .032A |       | ○ TBD |
| E58-4D120-1 | Narrow Body Diffuse RGBW Strip Light 12in   | Red .083A/ Green .061A/ Blue .057A/ White .063A |       | ○ TBD |
| E58-4D330-1 | Narrow Body Diffuse RGBW Strip Light 33in   | Red .230A/ Green .170A/ Blue .158A/ White .175A |       | ○ TBD |
| E58-4D680-1 | Narrow Body Diffuse RGBW Strip Light 68in   | Red .460A/ Green .340A/ Blue .316A/ White .350A |       | ○ TBD |



## E39 – Fluorescent Light LED Conversion Kit

- EMS Innovation Award recipient
- LED replacement for fluorescent lighting fixtures
- Performance of 50,000 hours
- 700 lumen (12”), and 1400 lumen (18”) models available

### • WIRE COLORS

- Black** - Ground,
- White** - Positive,
- Red (red/white model)** - Red LEDs

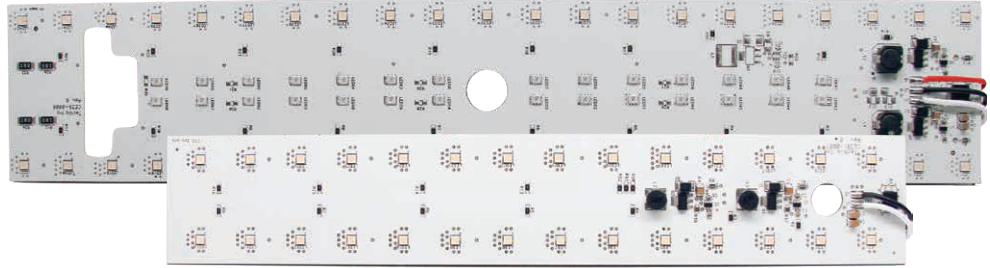

\*Easy-to-install adhesive backing

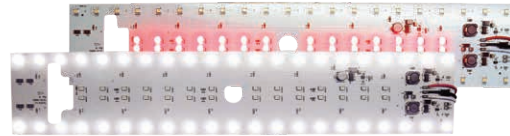

\*White/red combination available



| Part No.   | Part Description (Please see Index, or <a href="http://www.TecNiqInc.com">www.TecNiqInc.com</a> for a complete part list) | Amp Draw            | Color   | Pack |
|------------|---|---------------------|---|------|
| E39-L000-1 | LED Neutral White Light Replacement Kit for P716 and P718   | 1.37A-1.86A         | <input type="checkbox"/> <input type="radio"/>            | 10   |
| E39-L00R-1 | LED Neutral White/Red Combo Light Repl Kit for P716 and P718  | 1.86A / 0.48A (red) | <input checked="" type="checkbox"/> <input type="radio"/> | 10   |
| E39-L010-1 | LED Neutral White Light Replacement Kit for 712XL   | 2A-2.68A            | <input type="checkbox"/> <input type="radio"/>            | 10   |



## E22 – Motion Detection Sensor

- Convert existing lighting to motion activated lighting
- Great for step-in vans, delivery trucks, back end of trailers, and more
- Surface mounts horizontally, vertically, or at a 45° angle



### • WIRE COLORS

- Black** - Ground,
- Red** - Positive,
- White** - Device power output

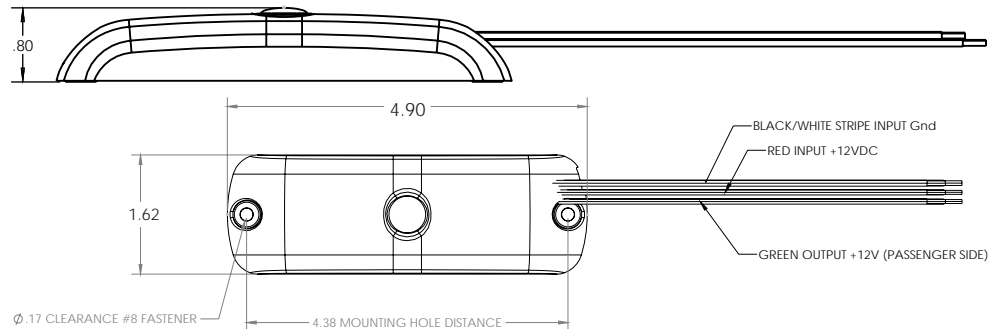

| Part No.   | Part Description (Please see Index, or <a href="http://www.TecNiqInc.com">www.TecNiqInc.com</a> for a complete part list) | Color | Pack |
|------------|---|-------|------|
| E22-XB00-1 | Interior Motion Sensor Light Controller Black   | Black | TBD  |
| E22-XW00-1 | Interior Motion Sensor Light Controller White   | White | TBD  |



# F99 – External WigWag Control Module

**NEW PRODUCT**



- External wig-wag module allows you to strobe non-flashing lights
- Great for use with garbage/refuse trucks, work trucks and more
- Current limit of 2 Amps

- **WIRE COLORS**  
**Black** - Ground,  
**Red** - Positive,  
**White** - Device power output

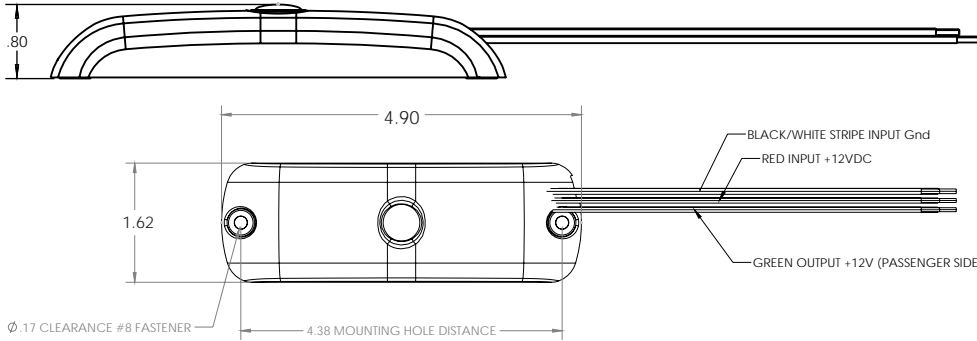

| Part No.   | Part Description (Please see Index, or <a href="http://www.TecNiqInc.com">www.TecNiqInc.com</a> for a complete part list) |
|------------|---|
| F99-XB00-1 | External WigWag Control Module  |

Electrical Wiring & Accessories



# J00 – Light Duty Trailer Vent Covers



\* Inquire about our Hydra Dipped options

- Designed for light duty trailers side air vents
- Made of UV resistant Polypropylene
- Dual weep holes allow any water to drain and not get inside the trailer

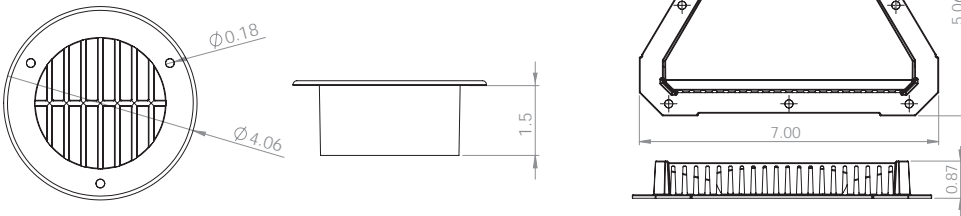

| Part No.   | Part Description (Please see Index, or <a href="http://www.TecNiqInc.com">www.TecNiqInc.com</a> for a complete part list) |
|------------|---|
| J00-0B00-1 | Exterior Vent Cover Black   |
| J00-0B01-1 | Interior Circular Vent Cover Black  |
| J00-0W00-1 | Exterior Vent Cover White   |
| J00-0W01-1 | Interior Circular Vent Cover White  |
| J01-0B00-1 | Injection Molded Wiring Box   |
| J02-0B00-1 | 3.5" Round Marine Cable Chase Grommet   |
| J03-0B00-1 | 6" Round Marine Cable Chase Grommet   |





# J01 – Light Duty Trailer Electrical Junction Box

- A new design for light duty trailers
- Made of UV resistant Polypropylene, or ABS

• **Available Colors**  
**Black, Grey and White**

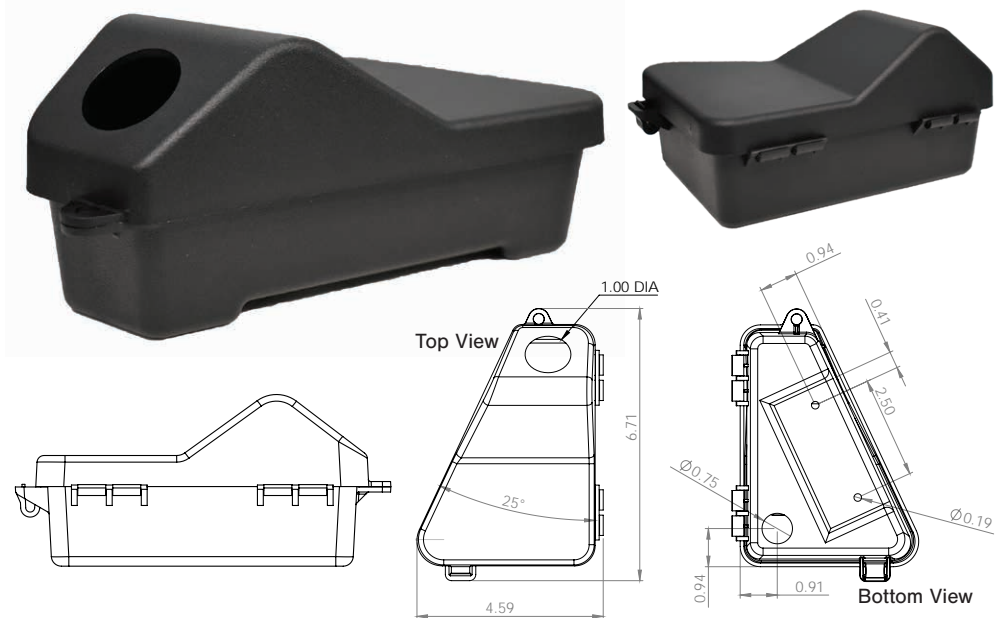

| Part No.   | Part Description (Please see Index, or <a href="http://www.TecNiqInc.com">www.TecNiqInc.com</a> for a complete part list) |   |
|------------|---|---|
| J01-0B00-1 | Injection Molded Wiring Box   | - |



# S99 – Side Marker/Clearance Light Connectors

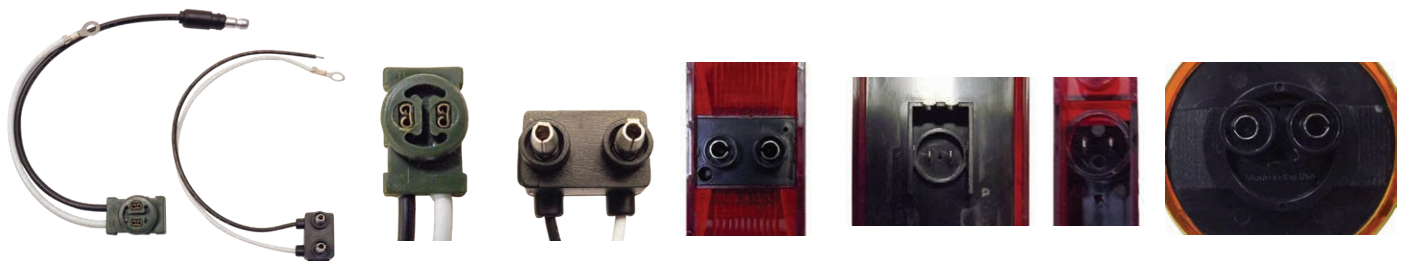

| Part No.   | Part Description (Please see Index, or <a href="http://www.TecNiqInc.com">www.TecNiqInc.com</a> for a complete part list) |   |
|------------|---|---|
| S99-0010-1 | T12-6" 2-Pole with #6 GND Lug   | - |
| S99-0035-1 | S35 2-Pole Sure-Seal w/.180" Bullet and #6 GND Lug 90 deg.  | - |
| S99-0A35-1 | S35 2-Pole Sure-Seal w/.180" Bullet and 1" #10 GND Lug  | - |



# T99 – Tail Light Connectors

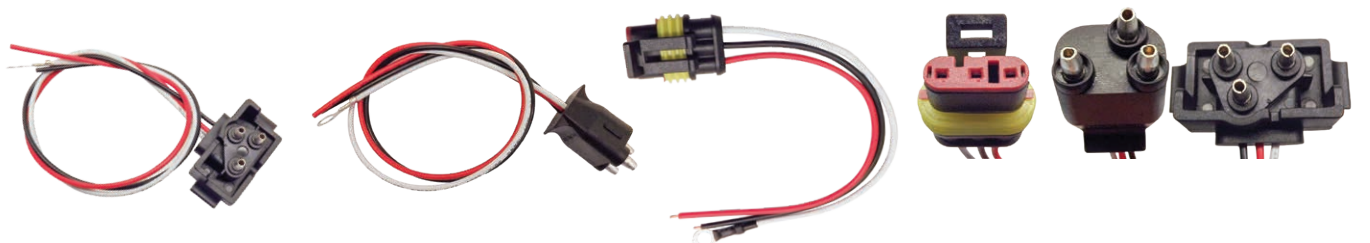

| Part No.   | Part Description (Please see Index, or <a href="http://www.TecNiqInc.com">www.TecNiqInc.com</a> for a complete part list) |   |
|------------|---|---|
| T99-0010-1 | 12" 3-Pole .156" Bullet w/#6 GND Lug - Straight   | - |
| T99-0020-1 | 12" 3-Pole .156" Bullet w/#6 GND Lug - 90 degree  | - |
| T99-0040-1 | Amp - Pigtail Wire Adapter  | - |

Electrical Wiring & Accessories



# T99 – 4-Pole Wiring Harness

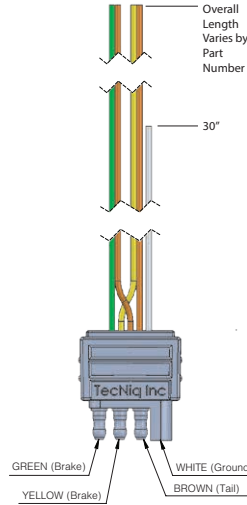
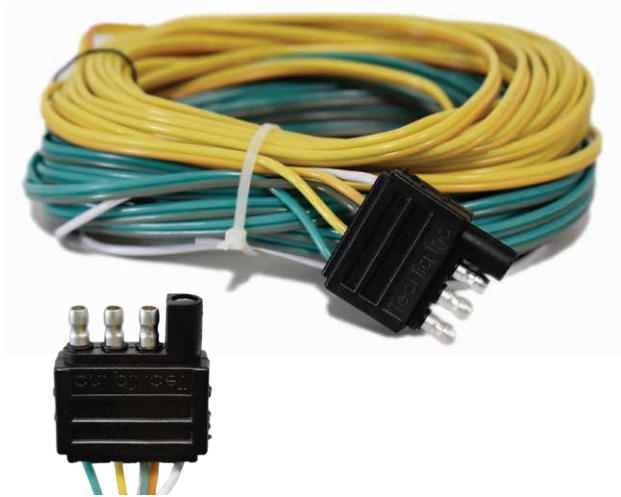

- Ergonomic plug, provides grip for easier plug and unplugging from your vehicle
- The 4-Pin design is an industry standard for taillights, brake lights and turn signals
- Bonded wires and molded rubber protect by SAE J-1128 standards

- **WIRE COLORS**  
**Green** - Brake,  
**Yellow** - Brake,  
**White** - Ground,  
**Brown** - Tail

| Part No.   | Part Description (Please see Index, or <a href="http://www.TecNiqInc.com">www.TecNiqInc.com</a> for a complete part list) | Connector |
|------------|---|-----------|
| T99-0090-1 | 20ft 4 pole Wire Harness  | 4-Pin     |
| T99-0090-1 | 25ft 4 pole Wire Harness  | 4-Pin     |
| T99-0090-1 | 30ft 4 pole Wire Harness  | 4-Pin     |
| T99-0090-1 | 35ft 4 pole Wire Harness  | 4-Pin     |

Electrical Wiring & Accessories



# W01 – Bullet & Barrel Wire Extenders

**NEW PRODUCT**



- All new Wire Harness Extenders help bridge the potential gap between old wiring and new lights
- Available in **0.156"** or **0.180"** bullets & barrels
- 2 conductor bonded wire separates wires on either end 2" back

| Part No.   | Part Description (Please see Index, or <a href="http://www.TecNiqInc.com">www.TecNiqInc.com</a> for a complete part list) | Connector             |
|------------|---|-----------------------|
| W01-0001-1 | 2ft 18AWG Extension Harness   | 0.156 bullets/barrels |
| W01-0002-1 | 4ft 18AWG Extension Harness   | 0.156 bullets/barrels |
| W01-0003-1 | 6ft 18AWG Extension Harness   | 0.156 bullets/barrels |
| W01-0004-1 | 2ft 18AWG Extension Harness   | 0.180 bullets/barrels |
| W01-0005-1 | 4ft 18AWG Extension Harness   | 0.180 bullets/barrels |
| W01-0006-1 | 6ft 18AWG Extension Harness   | 0.180 bullets/barrels |



## R03/05/10 – Reflexite® DOT Grade Conspicuity Tape

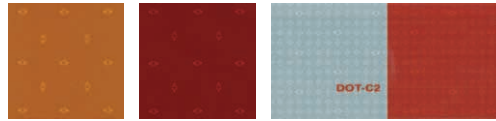

- Reflexite® Conspicuity Tape
- V82 OEM Grade Tape
- Amber & Red 3" Round SAE/DOT Reflectors
- Amber & Red 2"x3.5" Rectangle SAE/DOT Reflectors

| Part No.   | Part Description (Please see Index, or <a href="http://www.TecNiqInc.com">www.TecNiqInc.com</a> for a complete part list) | Color | Pack |
|------------|---|-------|------|
| R03-0A00-1 | Amber 3" Round Reflector Orafol - V32-1749-030026   | Amber | 1    |
| R03-0R00-1 | Red 3" Round Reflector Orafol - V32-1249-030026   | Red   | 1    |
| R05-0A00-1 | Amber 2" x 3.5" Rectangular SAE Reflector Orafol - V32-1749-020168  | Amber | 1    |
| R05-0R00-1 | Red 2" x 3.5" Rectangular SAE Reflector Orafol - V32-1249-020168  | Red   | 1    |
| R10-0RW0-1 | Red 11" x White 7" OEM Grade DOT - V82-5549-020150  | Red   | 1    |
| R10-0W00-1 | White 2" x 150' OEM Grade DOT   | White | 1    |



## E99 – Rotary & Slide Dimmer Switches

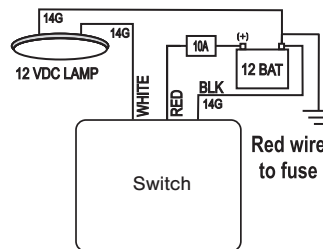

- Utilizes Puls Width Modulation
- Rated up to 15 Amps
- Attaches with hidden fasteners

- **WIRE COLORS**  
**Black** - Ground,  
**Red** - To Power Source(+),  
**White** - To LED Light

| Part No.   | Part Description (Please see Index, or <a href="http://www.TecNiqInc.com">www.TecNiqInc.com</a> for a complete part list) |   |
|------------|---|---|
| E99-D001-1 | Dimmer Rotary   | - |
| E99-D002-1 | Dimmer Slide  | - |



## Basic Equipment Required on All Trucks, Buses, & MPVs

| DESCRIPTION |   | MANDATORY REQUIREMENTS |  |           |             |   |   |
|-------------|---|------------------------|--|-----------|-------------|---|---|
| Equipment   | (SAE Lens Coding)   | Functional Purpose     | QTY  | Color     | Location    | Height (in) From Ground   |   |
| <b>1</b>    | <b>Headlamps - Lower Beam</b><br>-US requires "DOT" lettering on lens<br>-US & Canada require light source code on lens | (H, HR)                | Forward road illumination                                  | Min 2     | White       | On front - symmetrical - as far apart as practicable<br>- 4 lamp system - outboard or above upper beams | 22"- 54"                                    |
|             | <b>Headlamps - Upper Beam</b><br>-US requires "DOT" lettering on lens<br>-US & Canada require light source code on lens | (H, HR)                | Forward road illumination                                  | Min 2     | White       | On front - symmetrical<br>- 4 lamp system - inboard or below lower beams                                | 22"- 54"                                    |
|             | <b>Parking Lamps</b><br>-Vehicles less than 80" wide  | (P)                    | Indicate parked vehicle                                    | Min 2     | White/Amber | On the front - symmetrical - as far apart as practicable  | 15"- 72"                                    |
|             | <b>Daytime Running Lamps</b><br>-US - Optional - requires "DRL" lettering if not headlamp<br>-Canada - Required         | (Y2)                   | Indicate in use vehicle                                    | Min 2     | White/Amber |   | 15" minimum<br>*Max depends on type         |
|             | <b>Front Turn Signal/Hazard Warning Lamps</b>   | (I)                    | Indicates direction of turn/identify disabled vehicle      | Min 2     | Amber       | On the front - symmetrical - as far apart as practicable  | 15"- 83"                                    |
| <b>2</b>    | <b>Front Clearance Lamps</b><br>-Vehicles 80" wide or wider   | (P2, PC* or P3, PC2*)  | Show vehicle's width                                       | Min 2     | Amber       | At widest point - symmetrical - as far forward as practicable - facing forward                          | As high as practicable                      |
| <b>3</b>    | <b>Front Identification Lamps (ID)</b><br>-Vehicles 80" wide or wider   | (P2 or P3)             | Indicate presence of a wide vehicle                        | Exactly 3 | Amber       | On the front - center - horizontally spaced 6"- 12" apart   | As high as practicable or on top of the cab |
| <b>4a</b>   | <b>Front Side Marker Lamps</b>  | (P2, PC* or P3, PC2*)  | Indicate vehicle presence & length                         | Min 2     | Amber       | Each side at front - as far forward as practicable  | 15" minimum                                 |
| <b>4b</b>   | <b>Front Side Reflex Reflectors</b>   | (A)                    |  | Min 2     | Amber       | Each side at front - as far forward as practicable facing sideways                                      | 15"- 60"                                    |
| <b>5a</b>   | <b>Rear Side Marker Lamps</b>   | (P2, PC* or P3, PC2*)  | Indicate vehicle presence & length                         | Min 2     | Red         | Each side at rear - as far back as practicable  | 15" minimum                                 |
| <b>5b</b>   | <b>Rear Side Reflex Reflectors</b>  | (A)                    |  | Min 2     | Red         | Each side at rear - as far back as practicable facing sideways  | 15"- 60"                                    |
| <b>6</b>    | <b>Rear Clearance Lamps</b><br>-Vehicles 80" wide or wider<br>-Not required on truck tractors                           | (P2, PC* or P3, PC2*)  | Shows veh. width- MAY NOT be combined with tail lamps      | Min 2     | Red         | At widest point - symmetrical - on the rear or near the rear - facing Rearward                          | 15" minimum                                 |
| <b>7</b>    | <b>Rear Identification Lamps</b><br>-Vehicles 80" wide or wider<br>-Not required on truck tractors                      | (P2 or P3)             | Indicate Presence of Long Vehicle                          | Exactly 3 | Red         | On the rear - center, facing rearward - horizontally spaced 6"- 12" apart                               | 15"- 60"                                    |
| <b>8</b>    | <b>Tail Lamps</b>   | (T)                    | Indicate vehicle's presence and width                      | Min 2     | Red         | On the rear - symmetrical as far apart as practicable   | 15"- 72"                                    |
|             | <b>Stop Lamps</b>   | (S)                    | Indicate Braking   | Min 2     | Red         |   |   |
|             | <b>Rear Turn Signal/Hazard Warning Lamps</b>  | (I)                    | Indicate direction of turn/identify disabled vehicle       | Min 2     | Red/Amber   |   | 15"- 83"                                    |
|             | <b>Rear Reflex Reflectors</b>   | (A)                    | Show vehicle's presence and width                          | Min 2     | Red         |   | 15"- 60"                                    |
| <b>9</b>    | <b>Backup Lamp</b>  | (R)                    | Illuminates ground behind the vehicle and alert road users | Min 1     | White       | Rear  | No requirement                              |
| <b>10</b>   | <b>License Plate Lamp(s)</b>  | (L)                    | Illuminates license plate                                  | Min 1     | White       | On the rear - above or at the sides of license plate  | No requirement                              |
| <b>11</b>   | <b>Center High Mounted Stop Lamp</b>  | (U3)                   | Indicates Braking  | Min 1     | Red         | On the rear - centerline of the vehicle   | 34" minimum                                 |

\*Photometrically certified at installation angle

### Length - 30' or longer

| DESCRIPTION |  | MANDATORY REQUIREMENTS |                                   |       |          |   |             |
|-------------|--|------------------------|-----------------------------------|-------|----------|---|-------------|
| Equipment   | (SAE Lens Coding)                          | Functional Purpose     | QTY                               | Color | Location | Height (in) From Ground                 |             |
| <b>12a</b>  | <b>Intermediate Side Marker Lamps</b>      | (P2 or P3)             | Indicate presence of long vehicle | Min 2 | Amber    | Each side near center                   | 15" minimum |
| <b>12b</b>  | <b>Intermediate Side Reflex Reflectors</b> | (A)                    | Indicate presence of long vehicle | Min 2 | Amber    | Each side near center - Facing Sideways | 15"- 60"    |

### Truck Tractors

| DESCRIPTION           |                                | MANDATORY REQUIREMENTS                            |  |  |  |            |   |
|-----------------------|--------------------------------|---|--|--|--|------------|---|
| Conspicuity Treatment | DOT Coding                     | QTY   | Color  | Location   | Height (in) From Ground  | Options    |   |
| <b>9</b>              | <b>Rear Upper Body Marking</b> | DOT-C, DOT-C2, DOT-C3, DOT-C4                     | Exactly 2 pairs of 300mm (11.8") long strips | White  | On the rear upper corners of cab - facing rearward                             | At the top | Rear lower body and side conspicuity treatment may also be solid white, solid amber, or white and amber |
| <b>11</b>             | <b>Rear Marking</b>            | Exactly 2 sections of min 600mm (24") long strips | Red/White                                    | Rear - facing rearward - on fenders, on mud flap brackets, or within 300mm below top of mudflaps | As horizontal and as close to the range of 15"- 60" from ground as practicable |            |   |

# Truck, Bus, & MPV Requirements

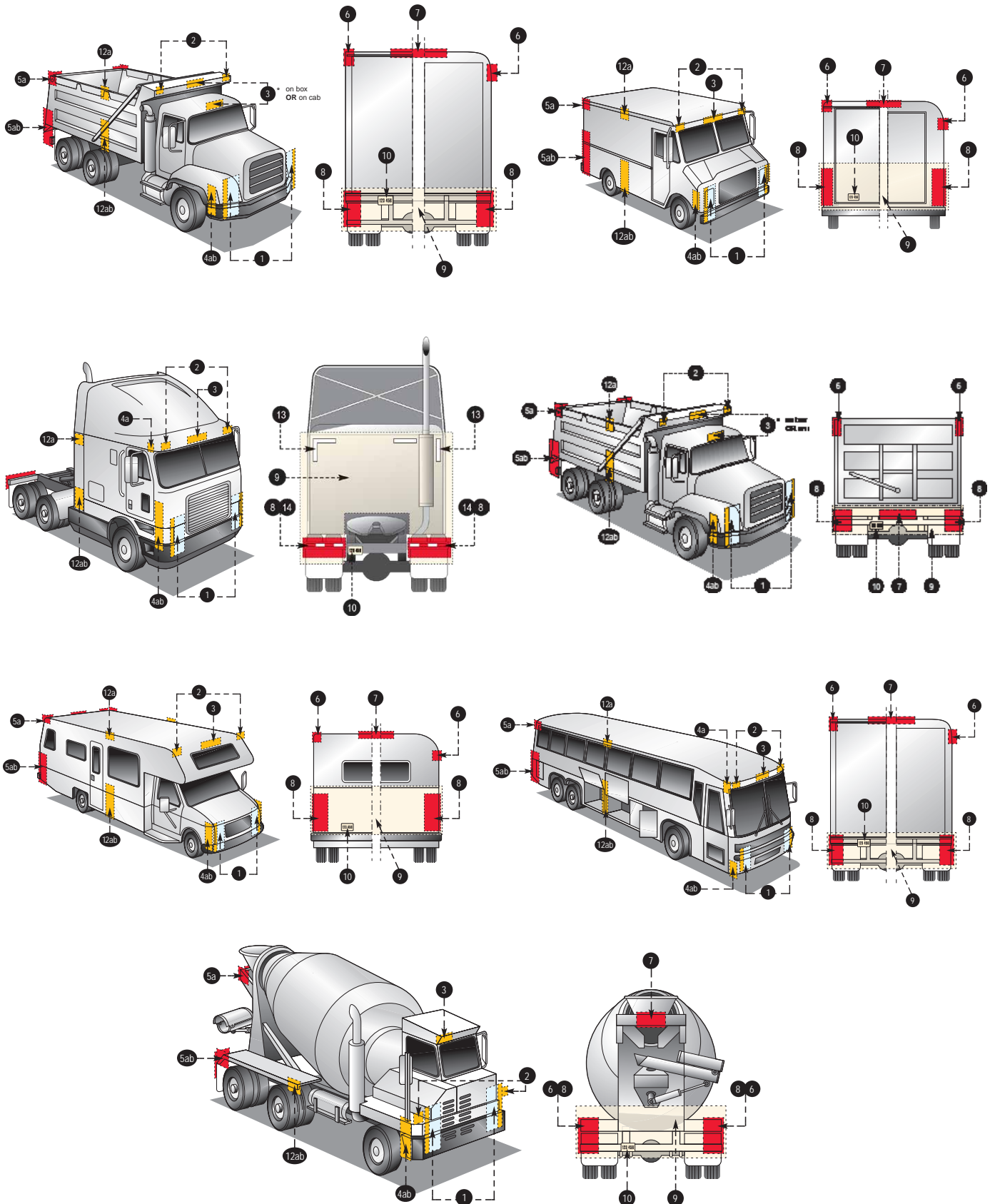

## Basic Equipment Required on All Trailers

|           | DESCRIPTION                  |                       |                                    |       | MANDATORY REQUIREMENTS |  |  |
|-----------|------------------------------|-----------------------|------------------------------------|-------|------------------------|--|--|
|           | Equipment                    | (SAE Lens Coding)     | Functional Purpose                 | QTY   | Color                  | Location   | Height (in) From Ground                          |
| <b>1</b>  | Tail Lamps                   | (T)                   | Indicate vehicle presence & width  | Min 2 | Red                    | On the rear - symmetrical - as far apart as practicable            | 15"- 72"   |
|           | Stop Lamps                   | (S)                   | Indicate braking                   | Min 2 | Red                    |  | 15"- 72"   |
|           | Rear Turn Signal Lamps       | (I)                   | Indicate direction of turn         | Min 2 | Red/ Amber             |  | 15"- 83"   |
|           | Rear Reflex Reflectors       | (A)                   | Indicate vehicle presence & width  | Min 2 | Red                    |  | 15"- 60"   |
| <b>2</b>  | License Plate Lamps          | (L)                   | Illuminate license plate           | Min 1 | White                  | On the rear - above or at the sides of license plate               | No requirement                                   |
| <b>3</b>  | Rear Side Marker Lamps       | (P2, PC* or P3, PC2*) | Indicate vehicle presence & length | Min 2 | Red                    | Each side at rear - as far back as practicable                     | 15"- 60"<br>(no max for vehicles under 80" wide) |
|           | Rear Side Reflex Reflectors  | (A)                   |                                    | Min 2 | Red                    | Each side at rear - as far back as practicable facing sideways     | 15"- 60"   |
| <b>4a</b> | Front Side Marker Lamps      | (P2, PC* or P3, PC2*) | Indicate vehicle presence & length | Min 2 | Amber                  | Each side at front - as far forward as practicable                 | 15" minimum                                      |
| <b>4b</b> | Front Side Reflex Reflectors | (A)                   |                                    | Min 2 | Amber                  | Each side at front - as far forward as practicable facing sideways | 15"- 60"   |

\*Photometrically certified at installation angle

### Length - 30' or longer

|           | DESCRIPTION                         |                   |                                   |       | MANDATORY REQUIREMENTS |   |                         |
|-----------|-------------------------------------|-------------------|-----------------------------------|-------|------------------------|---|-------------------------|
|           | Equipment                           | (SAE Lens Coding) | Functional Purpose                | QTY   | Color                  | Location                                | Height (in) From Ground |
| <b>5a</b> | Intermediate Side Marker Lamps      | (P2 or P3)        | Indicate presence of long vehicle | Min 2 | Amber                  | Each side near center - Facing Sideways | 15" minimum             |
| <b>5b</b> | Intermediate Side Reflex Reflectors | (A)               | Indicate presence of long vehicle | Min 2 | Amber                  |   | 15"- 60"                |

### Width - 80" or wider

|          | DESCRIPTION               |                       |   |           | MANDATORY REQUIREMENTS |  |                         |
|----------|---------------------------|-----------------------|---|-----------|------------------------|--|-------------------------|
|          | Equipment                 | (SAE Lens Coding)     | Functional Purpose                                    | QTY       | Color                  | Location   | Height (in) From Ground |
| <b>6</b> | Rear Clearance Lamps      | (P2, PC* or P3, PC2*) | Shows veh. width- MAY NOT be combined with tail lamps | Min 2     | Red                    | At widest point - symmetrical - on or near the rear - facing Rearward          | 15" minimum             |
| <b>7</b> | Rear Identification Lamps | (P2 or P3)            | Indicate Presence of Long Vehicle                     | Exactly 3 | Red                    | On the rear - center, facing rearward - horizontally spaced 6"- 12" apart      | 15"- 60"                |
| <b>8</b> | Front Clearance Lamps     | (P2, PC* or P3, PC2*) | Show Vehicle's Width                                  | Min 2     | Amber                  | At widest point - symmetrical - as far forward as practicable - facing forward | As high as practicable  |

\*Photometrically certified at installation angle

### Width - 80" or wider AND GVWR of 10,000 lbs or MORE







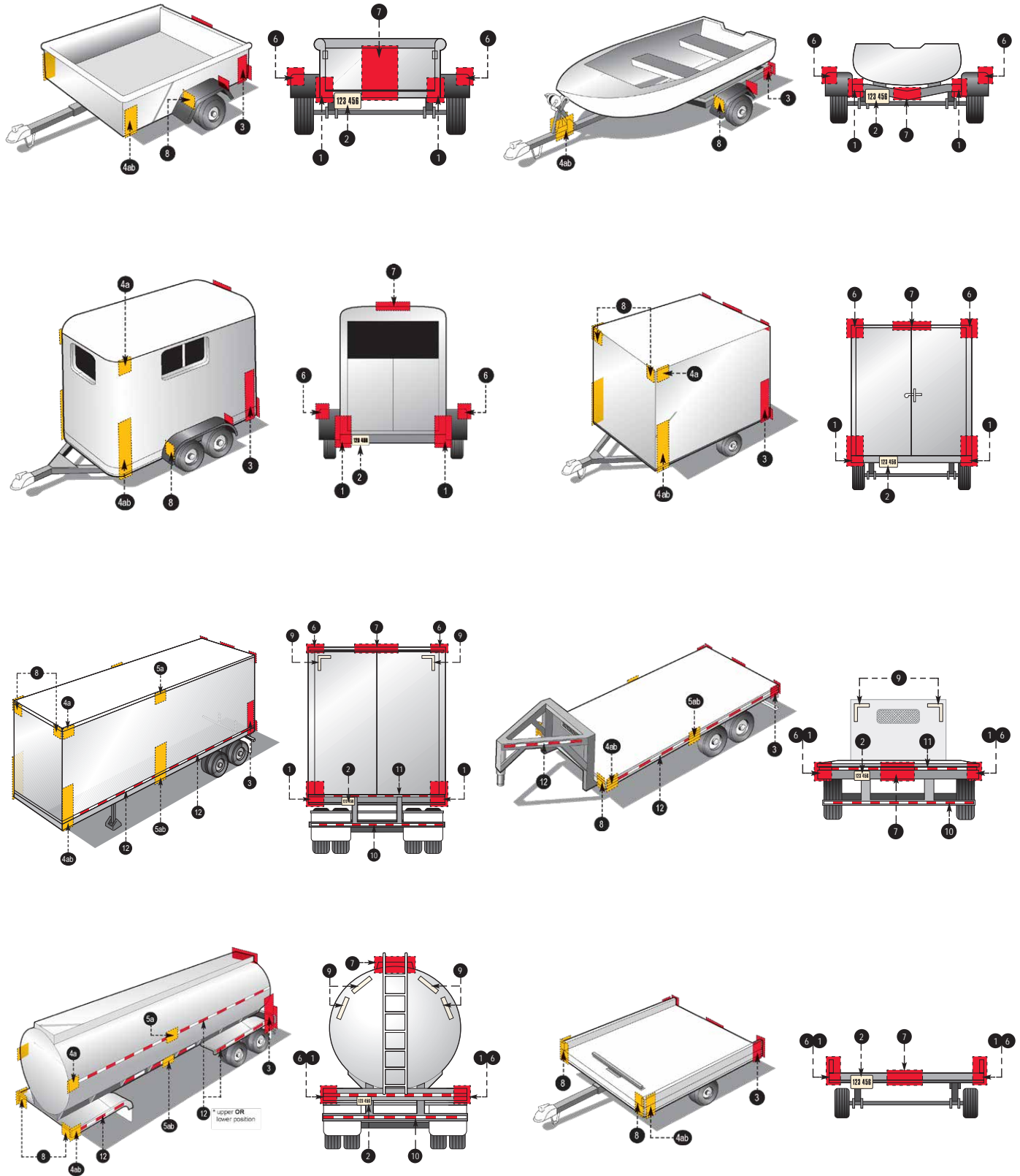





























|           | DESCRIPTION             |                               |  | MANDATORY REQUIREMENTS  |  |  |   |
|-----------|-------------------------|-------------------------------|--|-------------------------|--|--|---|
|           | Conspicuity Treatment   | DOT Coding                    | QTY  | Color                   | Location   | Height (in) From Ground  | Options   |
| <b>9</b>  | Rear Upper Body Marking | DOT-C, DOT-C2, DOT-C3, DOT-C4 | Exactly 2 pairs of 300mm (11.8") long strips | White                   | On the rear upper corners - facing rearward  | At the top   | Rear lower body and side conspicuity treatment may also be solid white, solid amber, or white and amber |
| <b>10</b> | Bumper Bar Marking      |                               | Continuous                                   | Red/White               | On the rear bumper bar's horizontal element - full width - facing rearward   | No requirement   |   |
| <b>11</b> | Rear Lower Body Marking |                               | Continuous                                   | Red/White (see options) | On the rear - full width of the vehicle - facing rearward  |  |   |
| <b>12</b> | Side Marking            |                               | See location                                 | Red/White (see options) | Each side - facing sideways - continuous, or evenly spaced over minimum of 50% of length, starts and ends as close to the front and rear of vehicle as practicable | As horizontal and as close to the range of 15"- 60" from ground as practicable |   |



## Trailer Requirements



| Part No.                                  | Part Description  |   | Std Pack | Connector    |
|---|---|---|----------|--------------|
| <b>D02 - Ladder Lights</b>                |   |   |          | <b>Pg</b>    |
| D05-3001-1                                | Ladder Light RGB 1 Section - 14" Section Length         |       | -        | Pigtail      |
| D05-3020-1                                | Ladder Light RGB 20 Section - 14" Section Length        |       | -        | Pigtail      |
| D05-3021-1                                | Ladder Light RGB 21 Section - 14" Section Length        |       | -        | Pigtail      |
| D05-3026-1                                | Ladder Light RGB 26 Section - 14" Section Length        |       | -        | Pigtail      |
| D05-3100-1                                | Ladder Light RGB 100 Sections - 14" Section Length      |       | -        | Pigtail      |
| D05-Z100-1                                | Ladder Light RGB 100 Sections - 13 9/32" Section Length |       | -        | Pigtail      |
| D02-A001-1                                | Ladder Light Amber 1 Section - 14" Section Length       |       | -        | Pigtail      |
| D02-B001-1                                | Ladder Light Blue 1 Sections - 14" Section Length       |       | -        | Pigtail      |
| D02-G001-1                                | Ladder Light Green 1 Sections - 14" Section Length      |       | -        | Pigtail      |
| D02-R001-1                                | Ladder Light Red 1 Sections - 14" Section Length        |       | -        | Pigtail      |
| D02-W001-1                                | Ladder Light White1 Sections - 14" Section Length       |       | -        | Pigtail      |
| <b>D03 - Mini Light</b>                   |   |   |          | <b>Pg</b>    |
| D03-0B45-1                                | Mini Light Black 45 Degree Case                         |   | 50       | -            |
| D03-0BH0-1                                | Mini Light Black Horizontal Case                        |   | 50       | -            |
| D03-0BV0-1                                | Mini Light Black Vertical Case                          |   | 50       | -            |
| D03-0G00-1                                | D03 Gasket  |   | 50       | -            |
| D03-0S45-1                                | D03 Stainless 45 Degree Cover                           |   | 50       | -            |
| D03-0SH0-1                                | D03 Horizontal Stainless Cover                          |   | 50       | -            |
| D03-0SV0-1                                | D03 Vertical Stainless Cover                            |   | 50       | -            |
| D03-0W45-1                                | Mini Light White 45 Degree Case                         |   | 50       | -            |
| D03-0WH0-1                                | Mini Light White Horizontal Case                        |   | 50       | -            |
| D03-0WV0-1                                | Mini Light White Vertical Case                          |   | 50       | -            |
| D03-3000-1                                | Mini Light Linear Body RGB                              |   | 50       | Pigtail (9") |
| D03-A000-1                                | Mini Light Linear Body Amber                            |   | 50       | Pigtail (9") |
| D03-A450-1                                | Mini Lamp Body 45 Degree Amber                          |   | 50       | Pigtail (9") |
| D03-B000-1                                | Mini Light Linear Body Blue                             |   | 50       | Pigtail (9") |
| D03-B450-1                                | Mini Lamp Body 45 Degree Blue                           |   | 50       | Pigtail (9") |
| D03-G000-1                                | Mini Light Linear Body Green                            |   | 50       | Pigtail (9") |
| D03-G450-1                                | Mini Lamp Body 45 Degree Green                          |   | 50       | Pigtail (9") |
| D03-R000-1                                | Mini Light Linear Body Red                              |   | 50       | Pigtail (9") |
| D03-R450-1                                | Mini Lamp Body 45 Degree Red                            |   | 50       | Pigtail (9") |
| D03-W000-1                                | Mini Light Linear Body White                            |   | 50       | Pigtail (9") |
| D03-W00F-1                                | Mini Light Linear Body White W/Deutsch Connector        |   | 50       | Pigtail (9") |
| D03-W450-1                                | Mini Lamp Body 45 Degree White                          |   | 50       | Pigtail (9") |
| <b>D04 - Dragon Light - Linear Series</b> |   |   |          | <b>Pg</b>    |
| D04-0BH0-1                                | Dragon Light Linear Horizontal Case Black               |   | 50       | -            |
| D04-0BV0-1                                | Dragon Light Linear Vertical Case Black                 |   | 50       | -            |
| D04-0SH0-1                                | Dragon Light Linear Horizontal Case SS                  |   | 50       | -            |

| Part No.                           | Part Description                                  |   | Std Pack | Connector             |
|------------------------------------|---|---|----------|-----------------------|
| D04-OSV0-1                         | Dragon Light Linear Vertical Case SS              |   | 50       | -                     |
| D04-0WH0-1                         | Dragon Light Linear Horizontal Case White         |   | 50       | -                     |
| D04-0WV0-1                         | Dragon Light Linear Vertical Case White           |   | 50       | -                     |
| D04-A000-1                         | Dragon Light Linear Body Amber                    |       | 50       | Pigtail (9")          |
| D04-A001-1                         | Dragon Light Linear Body Amber 36"                |       | 50       | Pigtail (36")         |
| D04-B000-1                         | Dragon Light Linear Body Blue                     |       | 50       | Pigtail (9")          |
| D04-B001-1                         | Dragon Light Linear Body Blue 36"                 |       | 50       | Pigtail (36")         |
| D04-D000-1                         | Dragon Light Linear Body Deep Red 9"              |       | 50       | Pigtail (9")          |
| D04-D001-1                         | Dragon Light Linear Body Deep Red 36"             |       | 50       | Pigtail (36")         |
| D04-G000-1                         | Dragon Light Linear Body Green                    |       | 50       | Pigtail (9")          |
| D04-G001-1                         | Dragon Light Linear Body Green 36"                |       | 50       | Pigtail (36")         |
| D04-J001-1                         | Dragon Light Linear Body Jade 36"                 |       | 50       | Pigtail (9")          |
| D04-N001-1                         | Dragon Light Linear Body Orange 36"               |       | 50       | Pigtail (36")         |
| D04-R000-1                         | Dragon Light Linear Body Red                      |       | 50       | Pigtail (9")          |
| D04-R001-1                         | Dragon Light Linear Body Red 36"                  |       | 50       | Pigtail (36")         |
| D04-R002-1                         | Dragon Light Linear Body Red 46"                  |       | 50       | Pigtail (46")         |
| D04-U001-1                         | Dragon Light Linear Body Ultraviolet 36"          |       | 50       | Pigtail (36")         |
| D04-W000-1                         | Dragon Light Linear Body White                    |       | 50       | Pigtail (9")          |
| D04-W001-1                         | Dragon Light Linear Body White 36"                |       | 50       | Pigtail (36")         |
| D04-W00F-1                         | Dragon Light Linear Body White Flood              |   | 50       | Pigtail (9")          |
| <b>D06 - 45° Accent/Step Light</b> |   |   |          | <b>Pg</b>             |
| D06-0G00-1                         | Step Light 45 Deg. Gasket                         |   | 50       | -                     |
| D06-WC00-1                         | Step Light White 45 Deg. W/Chrome Case            |   | 50       | Sheathed Pigtail (9") |
| <b>D07 - Accent Light</b>          |   |   |          | <b>Pg</b>             |
| D07-0B45-1                         | Accent Light Black 45 Degree Case                 |   | 50       | -                     |
| D07-0BH0-1                         | Accent Light Black Horizontal Case                |   | 50       | -                     |
| D07-0BV0-1                         | Accent Light Black Vertical Case                  |   | 50       | -                     |
| D07-0G00-1                         | D07 Gasket  |   | 50       | -                     |
| D07-0S45-1                         | D07 Stainless Cover 45 Degree                     |   | 50       | -                     |
| D07-0SH0-1                         | D07 Stainless Cover Horizontal                    |   | 50       | -                     |
| D07-0SV0-1                         | D07 Stainless Cover Vertical                      |   | 50       | -                     |
| D07-0W45-1                         | Accent Light White 45 Degree Case                 |   | 50       | -                     |
| D07-0WH0-1                         | Accent Light White Horizontal Case                |   | 50       | -                     |
| D07-0WV0-1                         | Accent Light White Vertical Case                  |   | 50       | -                     |
| D07-3000-1                         | Mini Lamp Body RGB                                |   | 50       | Pigtail (7")          |
| D07-300F-1                         | Mini Lamp Body RGB with DeutschMini Lamp Body RGB |   | 50       | Deutsch (7")          |
| D07-3450-1                         | Mini Lamp Body 45 RGB                             |   | 50       | Pigtail (7")          |
| D07-A000-1                         | Mini Lamp Body Amber                              |   | 50       | Pigtail (7")          |
| D07-A450-1                         | Mini Lamp Body 45 Degree Amber                    |   | 50       | Pigtail (7")          |







| Part No.   | Part Description               |   | Std Pack | Connector    |
|------------|--------------------------------|---|----------|--------------|
| D07-B000-1 | Mini Lamp Body Blue            |   | 50       | Pigtail (7") |
| D07-B450-1 | Mini Lamp Body 45 Degree Blue  |   | 50       | Pigtail (7") |
| D07-G000-1 | Mini Lamp Body Green           |   | 50       | Pigtail (7") |
| D07-G450-1 | Mini Lamp Body 45 Degree Green |   | 50       | Pigtail (7") |
| D07-R000-1 | Mini Lamp Body Red             |   | 50       | Pigtail (7") |
| D07-R450-1 | Mini Lamp Body 45 Degree Red   |   | 50       | Pigtail (7") |
| D07-U000-1 | Mini Lamp Body Ultraviolet     |   | 50       | Pigtail (7") |
| D07-W000-1 | Mini Lamp Body White           |   | 50       | Pigtail (7") |
| D07-W450-1 | Mini Lamp Body 45 Degree White |   | 50       | Pigtail (7") |











### D14 - Dragon Light - Oval Series

|            |  |   |    |               |
|------------|--|---|----|---------------|
| D14-0B00-1 | Dragon Light Oval Case Black                 |   | 50 | -             |
| D14-0S00-1 | Dragon Light Oval Case SS                    |   | 50 | -             |
| D14-0W00-1 | Dragon Light Oval Case White                 |   | 50 | -             |
| D14-A000-1 | Dragon Light Oval Body Amber                 |       | 50 | Pigtail (9")  |
| D14-A001-1 | Dragon Light Oval Body Amber 36"             |       | 50 | Pigtail (36") |
| D14-B000-1 | Dragon Light Oval Body Blue                  |       | 50 | Pigtail (9")  |
| D14-B001-1 | Dragon Light Oval Body Blue 36"              |       | 50 | Pigtail (36") |
| D14-D000-1 | Dragon Light Oval Body Deep Red - 9" Wire    |       | 50 | Pigtail (9")  |
| D14-D001-1 | Dragon Light Oval Body Deep Red 36"          |       | 50 | Pigtail (36") |
| D14-G000-1 | Dragon Light Oval Body Green                 |   | 50 | Pigtail (9")  |
| D14-G001-1 | Dragon Light Oval Body Green 36"             |   | 50 | Pigtail (36") |
| D14-N001-1 | Dragon Light Oval Body Orange 36"            |   | 50 | Pigtail (36") |
| D14-R000-1 | Dragon Light Oval Body Red                   |   | 50 | Pigtail (9")  |
| D14-R001-1 | Dragon Light Oval Body Red 36"               |   | 50 | Pigtail (36") |
| D14-U000-1 | Dragon Light Oval Body Ultraviolet - 9" Wire |   | 50 | Pigtail (9")  |
| D14-U001-1 | Dragon Light Oval Body Ultraviolet 36"       |   | 50 | Pigtail (36") |
| D14-W000-1 | Dragon Light Oval Body White                 |   | 50 | Pigtail (9")  |
| D14-W001-1 | Dragon Light Oval Body White 36"             |   | 50 | Pigtail (36") |
| D14-W00F-1 | Dragon Light Oval Body White Flood           |   | 50 | Pigtail (9")  |

### D16 - Link Lights

|            |   |   |    |              |
|------------|---|---|----|--------------|
| D16-WB00-1 | 16in High Powered Area Light            |   | 24 | Pigtail (9") |
| D16-WG00-1 | 16in High Powered Area Light Gray Base  |   | 24 | Pigtail (9") |
| D16-WW00-1 | 16in High Powered Area Light White Base |   | 24 | Pigtail (9") |

































































### D17 - Porch/Accent Light

|            |  |   |    |              |
|------------|--|---|----|--------------|
| D17-30S0-1 | Surface Mount RGB Accent Light             |   | 30 | Pigtail (9") |
| D17-BB00-1 | Porch/Accent Light Blue with Black Housing |   | 30 | Pigtail (9") |
| D17-W0S0-1 | Surface Mount White Accent Light           |   | 30 | Pigtail (9") |
| D17-WB00-1 | Porch/Accent Light Black                   |   | 30 | Pigtail (9") |
| D17-WS00-1 | Porch/Accent Light with Stainless Cover    |   | 30 | Pigtail (9") |

































































| Part No.                            | Part Description   |  | Std Pack | Connector      |
|-------------------------------------|--|--|----------|----------------|
| D17-WW00-1                          | Porch/Accent Light White   |  | 30       | Pigtail (9")   |
| <b>D18 - Aluminum Area Light</b>    |  |  |          |                |
| D18-WA12-1                          | Aluminum Exterior Light 12in Clear Anodize                           |  | -        | Pigtail (12")  |
| D18-WA24-1                          | Aluminum Exterior Light 24in Clear Anodize                           |  | -        | Pigtail (24")  |
| D18-WAP12-1                         | Aluminum Exterior Light Premium 12in Clear Anodize                   |  | -        | Pigtail (12")  |
| D18-WAP24-1                         | Aluminum Exterior Light Premium 24in Clear Anodize                   |  | -        | Pigtail (24")  |
| D18-WB00-1                          | Aluminum Exterior Area Light 24in Black                              |  | -        | Pigtail (24")  |
| D18-WB010-1                         | Aluminum Exterior Area Light 12in Black                              |  | -        | Pigtail (12")  |
| D18-WBP0-1                          | Aluminum Exterior Area Light Premium 24in Black                      |  | -        | Pigtail (24")  |
| D18-WBP10-1                         | Aluminum Exterior Area Light Premium 12in Black                      |  | -        | Pigtail (12")  |
| D18-WW12-1                          | Aluminum Exterior Light 12in White                                   |  | -        | Pigtail (12")  |
| D18-WW24-1                          | Aluminum Exterior Light 24in White                                   |  | -        | Pigtail (24")  |
| D18-WWP12-1                         | Aluminum Exterior Light Premium 12in White                           |  | -        | Pigtail (12")  |
| D18-WWP24-1                         | Aluminum Exterior Light Premium 24in White                           |  | -        | Pigtail (24")  |
| <b>D21 - Link Lights</b>            |  |  |          |                |
| D21-AC00-1                          | Emergency Accessory Light Amber                                      |  | 50       | Pigtail (4.5") |
| D21-BC00-1                          | Emergency Accessory Light Blue                                       |  | 50       | Pigtail (4.5") |
| D21-GC00-1                          | Emergency Accessory Light Green                                      |  | 50       | Pigtail (4.5") |
| D21-RC00-1                          | Emergency Accessory Light Red  |  | 50       | Pigtail (4.5") |
| D21-WC00-1                          | Emergency Accessory Light White                                      |  | 50       | Pigtail (4.5") |
| <b>D30 - Load Ramp Light</b>        |  |  |          |                |
| D30-WB00-1                          | LED High Output Surface Mount Load Light                             |  | 10       | Pigtail (9")   |
| D30-WB0B-1                          | LED High Output Surface Mount Load Light W/180 Bullets               |  | 10       | 0.180" Bullets |
| D30-WW0B-1                          | LED High Output Surface Mount Load Light White Housing W/180 Bullets |  | 10       | 0.180" Bullets |
| <b>E02 - Miniature Accent Light</b> |  |  |          |                |
| E02-B000-1                          | Miniature Accent Light, Blue, Clear Lens                             |  | 100      | Pigtail (7")   |
| E02-BB00-1                          | E02 Blue Miniature Accent Light Black Cover                          |  | 100      | Pigtail (7")   |
| E02-G000-1                          | Miniature Accent Light, Green, Clear Lens                            |  | 100      | Pigtail (7")   |
| E02-GB00-1                          | E02 Green Miniature Accent Light Black Cover                         |  | 100      | Pigtail (7")   |
| E02-R000-1                          | E02 Red Mini Accent Light  |  | 100      | Pigtail (7")   |
| E02-RB00-1                          | E02 Red Miniature Accent Light Black Cover                           |  | 100      | Pigtail (7")   |
| E02-W000-1                          | E02 White Mini Accent Light  |  | 100      | Pigtail (7")   |
| E02-WB00-1                          | E02 White Miniature Accent Light Black Cover                         |  | 100      | Pigtail (7")   |
| <b>E03 - Eon Series Light</b>       |  |  |          |                |
| E03-000G-1                          | Eon Light Linear Vertical Case Gasket                                |  | 50       | -              |
| E03-00HG-1                          | Eon Light Linear Horizontal Case Gasket                              |  | 50       | -              |
| E03-0BH0-1                          | Eon Light Linear Horizontal Case Black                               |  | 50       | -              |
| E03-0BV0-1                          | Eon Light Linear Vertical Case Black                                 |  | 50       | -              |
| E03-0SH0-1                          | Eon Light Linear Horizontal Case SS                                  |  | 50       | -              |

| Part No.                         | Part Description   |   | Std Pack | Connector              |
|----------------------------------|--|---|----------|------------------------|
| E03-0SV0-1                       | Eon Light Linear Vertical Case SS                              |   | 50       | -                      |
| E03-A001-1                       | Eon Light Linear Body Amber 36 in                              |       | 50       | Pigtail (36")          |
| E03-A003-1                       | Eon Light Linear Body Amber Dual Intensity 9 in                |       | 50       | Pigtail (9")           |
| E03-B001-1                       | Eon Light Linear Body Blue 36 in                               |       | 50       | Pigtail (36")          |
| E03-D001-1                       | Eon Light Linear Body Deep Red 36 in                           |       | 50       | Pigtail (36")          |
| E03-D003-1                       | Eon Light Linear Body Deep Red Dual Intensity 9 in             |       | 50       | Pigtail (9")           |
| E03-G001-1                       | Eon Light Linear Body Green 36 in                              |       | 50       | Pigtail (36")          |
| E03-J001-1                       | Eon Light Linear Body Jade 36"                                 |       | 50       | Pigtail (36")          |
| E03-L000-1                       | Eon Light Linear Body Neutral White                            |       | 50       | Pigtail (9")           |
| E03-M000-1                       | Eon Light Linear Body Warm White                               |       | 50       | Pigtail (9")           |
| E03-N001-1                       | Eon Light Linear Body Orange 36 in                             |       | 50       | Pigtail (36")          |
| E03-RGB1-1                       | EON Light RGB 82" Wire   |       | 50       | Sheathed Pigtail (82") |
| E03-W000-1                       | Eon Light Linear Body White                                    |       | 50       | Pigtail (9")           |
| E03-W001-1                       | Eon Light Linear Body White 36 in                              |       | 50       | Pigtail (36")          |
| E03-W00F-1                       | Eon Light Linear Body White Flood Lens                         |       | 50       | Pigtail (9")           |
| <b>E05 - Interior Area Light</b> |  |   |          |                        |
| E05-0B00-1                       | Interior Area Light - 1" Round Bar Mt. Adapter                 |   | 10       | Sheathed Pigtail (6")  |
| E05-WBS0-1                       | Interior Area Light Surface Mt.White LED Black Cover           |       | 10       | Sheathed Pigtail (6")  |
| E05-WSS0-1                       | Interior Area Light Surface Mt, White LED SS Cover             |       | 10       | Sheathed Pigtail (6")  |
| E05-WWS0-1                       | Interior Area Light, Surface Mt. White Cover                   |   | 10       | Sheathed Pigtail (6")  |
| <b>E06 - Silho-X 4" Series</b>   |  |   |          |                        |
| E06-3S00-1                       | Silho-X 4" Round RGB Light SS Trim Ring                        |   | 10       | Pigtail (9")           |
| E06-LS00-1                       | Silho-X 4" Round Neutral White Light SS Trim Ring              |   | 10       | Pigtail (9")           |
| E06-LS0R-1                       | Silho-X 4" Round Neutral White/Red Light SS Trim Ring          |   | 10       | Pigtail (9")           |
| E06-LSB0-1                       | Silho-X 4" Round Neutral White/Blue Combo Light SS Trim Ring   |   | 10       | Pigtail (9")           |
| E06-MN00-1                       | Silho-X 4" Round Warm White Light Satin Nickel Trim Ring       |   | 10       | Pigtail (9")           |
| E06-MS00-1                       | Silho-X 4" Round Warm White Light SS Trim Ring                 |   | 10       | Pigtail (9")           |
| E06-MS0F-1                       | Silho-X 4" Round Warm White Light Diffuse Lens SS Trim Ring    |   | 10       | Pigtail (9")           |
| E06-MS0R-1                       | Silho-X 4" Round Warm White/Red Combo Lt SS Trim Ring          |   | 10       | Pigtail (9")           |
| E06-MW00-1                       | Silho-X 4" Round Warm White Light, White Powder Coat Trim Ring |   | 10       | Pigtail (9")           |
| E06-MS0B-1                       | Silho-X 4" Round Warm White/Blue Combo Light SS Trim Ring      |   | 10       | Pigtail (9")           |
| E06-RS00-1                       | Silho-X 4" Round Red Light SS Trim Ring                        |   | 10       | Pigtail (9")           |
| E06-WB00-1                       | Silho-X 4" Round White Light Black Powder Coat Trim Ring       |   | 10       | Pigtail (9")           |
| E06-WB0R-1                       | Silho-X 4" Round White/Red Combo Light Black Trim Ring         |   | 10       | Pigtail (9")           |
| E06-WN00-1                       | Silho-X 4" Round White Light Satin Nickel Trim Rin             |   | 10       | Pigtail (9")           |
| E06-WS00-1                       | Silho-X 4" Round White Light SS Trim Ring                      |   | 10       | Pigtail (9")           |
| E06-WS0B-1                       | Silho-X 4" Round White/Blue Combo Light SS Trim Ring           |   | 10       | Pigtail (9")           |
| E06-WS0F-1                       | Silho-X 4" Round White Light Diffuse Lens SS Trim Ring         |   | 10       | Pigtail (9")           |
| E06-WS0R-1                       | Silho-X 4" Round White/Red Combo Light SS Trim Ring            |   | 10       | Pigtail (9")           |











































































| Part No.                                      | Part Description  |   | Std Pack | Connector        |
|---|---|---|----------|------------------|
| E06-WSRF-1                                    | Silho-X 4" Round White/Red Combo Lt Diffuse Lens SS Trim Ring     |       | 10       | Pigtail (9")     |
| E06-WW00-1                                    | Silho-X 4" Round White Light White Powder Coat Trim Ring          |       | 10       | Pigtail (9")     |
| <b>E07 - Emergency Vehicle Interior Light</b> |   |   |          |                  |
| E07-WC00-1                                    | White Emergency Vehicle Interior Light Chrome Trim                |       | 10       | Pigtail (9")     |
| E07-WW00-1                                    | White Emergency Vehicle Interior Light White Trim                 |       | 10       | Pigtail (9")     |
| <b>E08 - Emergency Vehicle Interior Light</b> |   |   |          |                  |
| E08-LA20-1                                    | 8" EV Neutral White Interior Light Aluminum Trim - 18 LED's - MRI |       | 10       | Pigtail (9")     |
| E08-LC00-1                                    | 8" EV White Interior Light Chrome Trim - 31 LED's                 |       | 10       | Pigtail (9")     |
| E08-LC10-1                                    | 8" EV White Interior Light Chrome Trim - 18 LED's 8 EV            |       | 10       | Pigtail (9")     |
| E08-LC20-1                                    | 8" EV White Interior Light Chrome Trim - 18 LED's - MRI           |       | 10       | Pigtail (9")     |
| E08-LCR0-1                                    | 8" EV White Red Interior Light Chrome Trim                        |       | 10       | Pigtail (9")     |
| E08-LW00-1                                    | 8" EV White Interior Light White Trim - 31 LED's                  |       | 10       | Pigtail (9")     |
| E08-LW10-1                                    | 8" EV White Interior Light White Trim - 18 LED's                  |       | 10       | Pigtail (9")     |
| E08-LW20-1                                    | 8" EV White Interior Light White Trim - 18 LED's - MRI            |       | 10       | Pigtail (9")     |
| E08-LWR0-1                                    | 8" EV White Red Interior Light White Trim                         |       | 10       | Pigtail (9")     |
| E08-WC00-1                                    | 8" EV White Interior Light Chrome Trim - 31 LED's                 |       | 10       | Pigtail (9")     |
| E08-WC10-1                                    | 8" EV White Interior Light Chrome Trim - 18 LED's 8 EV"           |       | 10       | Pigtail (9")     |
| E08-WCR0-1                                    | 8" EV White Red Interior Light Chrome Trim                        |       | 10       | Pigtail (9")     |
| E08-WW00-1                                    | 8" EV White Interior Light White Trim - 31 LED's                  |     | 10       | Pigtail (9")     |
| E08-WW10-1                                    | 8" EV White Interior Light White Trim - 18 LED's                  |   | 10       | Pigtail (9")     |
| E08-WW20-1                                    | 8" EV White Interior Light White Trim - 18 LED's - MRI            |   | 10       | Pigtail (9")     |
| E08-WWR0-1                                    | 8" EV White Red Interior Light White Trim                         |   | 10       | Pigtail (9")     |
| <b>E10 - Ground/Pump Panel Light</b>          |   |   |          |                  |
| E10-B000-1                                    | EV Ground Light Blue  |   | 10       | Sheathed Pigtail |
| E10-C000-1                                    | EV Ground/Pump Panel Light Cool White                             |   | 10       | Sheathed Pigtail |
| E10-G000-1                                    | EV Ground Light Green   |   | 10       | Sheathed Pigtail |
| E10-G00F-1                                    | EV Ground/Pump Panel Green Light w/ DT04-2P                       |   | 10       | Sheathed Pigtail |
| E10-GS00-1                                    | EV Ground/Pump Panel Green Light with SS Bracket                  |   | 10       | Sheathed Pigtail |
| E10-R000-1                                    | EV Ground/Pump Panel Light Red                                    |   | 10       | Sheathed Pigtail |
| E10-RS00-1                                    | EV Ground/Pump Panel Light Red with SS Bracket                    |   | 10       | Sheathed Pigtail |
| E10-W000-1                                    | EV Ground/Pump Panel Light  |   | 10       | Sheathed Pigtail |
| E10-W00F-1                                    | EV Ground/Pump Panel Light w/ 2P Duestch Connector                |   | 10       | Sheathed Pigtail |
| E10-WS00-1                                    | EV Ground/Pump Panel Light with SS Bracket                        |   | 10       | Sheathed Pigtail |
| E10-WS0F-1                                    | EV Ground/Pump Panel Light with SS Bracket W/2P Duetsch Connector |   | 10       | Sheathed Pigtail |
| <b>E11 - Silho-X 1.5" Series</b>              |   |   |          |                  |
| E11-AS01-1                                    | Silho-X 1.5" Round Amber Light SS Trim Ring 36"                   |   | 10       | Pigtail (36")    |
| E11-BS01-1                                    | Silho-X 1.5" Round Blue Light SS Trim Ring 36"                    |   | 10       | Pigtail (36")    |
| E11-DS01-1                                    | Silho-X 1.5" Round Deep Red Light SS Trim Ring 36"                |   | 10       | Pigtail (36")    |
| E11-GS01-1                                    | Silho-X 1.5" Round Green Light SS Trim Ring 36"                   |   | 10       | Pigtail (36")    |





















| Part No.                            | Part Description   |   | Std Pack | Connector        |
|-------------------------------------|--|---|----------|------------------|
| E11-JS01-1                          | Silho-X 1.5" Round Jade Light SS Trim Ring 36"               |       | 10       | Pigtail (36")    |
| E11-LS00-1                          | Silho-X 1.5" Round Neutral White light SS Trim Ring          |       | 10       | Pigtail (9")     |
| E11-MS00-1                          | Silho-X 1.5" Round Warm White Light SS Trim Ring             |       | 10       | Pigtail (9")     |
| E11-MS0F-1                          | Silho-X 1.5" Round Warm White Light Diffuse Ln SS Trim Ring  |       | 10       | Pigtail (9")     |
| E11-NS01-1                          | Silho-X 1.5" Round Orange Light SS Trim Ring 36"             |       | 10       | Pigtail (36")    |
| E11-RS00-1                          | Silho-X 1.5" Round Red Light - SS Trim Ring                  |       | 10       | Pigtail (9")     |
| E11-TS01-1                          | Silho-X 1.5" Round Teal Light - SS Trim Ring - 36" Wire      |       | 10       | Pigtail (36")    |
| E11-WS00-1                          | Silho-X 1.5" Round White Light SS Trim Ring                  |       | 10       | Pigtail (9")     |
| E11-WS01-1                          | Silho-X 1.5" Round White Light SS Trim Ring 36"              |       | 10       | Pigtail (36")    |
| E11-WS0F-1                          | Silho-X 1.5" Round White Light Diffuse Ln SS Trim Ring       |       | 10       | Pigtail (9")     |
| <b>E12 -Dome Light</b>              |  |   |          |                  |
| E12-WB0R-1                          | White Red Combo Dome Light w/ 3P Conn                        |       | 36       | 3-Pin            |
| E12-WB0RP-1                         | White Red Combo Dome Light w/ Pigtails                       |       | 36       | Pigtail (9")     |
| <b>E13 - Silho-X 2.75" Series</b>   |  |   |          |                  |
| E13-3S00-1                          | Silho-X 2.75" Round RGB Light SS Trim Ring                   |       | 20       | Pigtail (9")     |
| E13-AB10-1                          | Silho-X 2.75" Round LP Amber Light - Black Trim Ring         |       | 20       | Pigtail (9")     |
| E13-AW10-1                          | Silho-X 2.75" Round LP Amber Light - White Trim Ring         |       | 20       | Pigtail (9")     |
| E13-BB10-1                          | Silho-X 2.75" Round LP Blue Light - Black Trim Ring          |       | 20       | Pigtail (9")     |
| E13-BW10-1                          | Silho-X 2.75" Round LP Blue Light - White Trim Ring          |       | 20       | Pigtail (9")     |
| E13-GB10-1                          | Silho-X 2.75" Round LP Green Light - Black Trim Ring         |   | 20       | Pigtail (9")     |
| E13-GW10-1                          | Silho-X 2.75" Round LP Green Light - White Trim Ring         |   | 20       | Pigtail (9")     |
| E13-LS00-1                          | Silho-X 2.75" Round Neutral White Light SS Trim Ring         |   | 20       | Pigtail (9")     |
| E13-LS0R-1                          | Silho-X 2.75" Round Neutral White/Red Light SS Trim Ring     |   | 20       | Pigtail (9")     |
| E13-MS00-1                          | Silho-X 2.75" Round Warm White Light SS Trim Ring            |   | 20       | Pigtail (9")     |
| E13-MS0F-1                          | Silho-X 2.75" Round Warm White Light Diffuse Ln SS Trim Ring |   | 20       | Pigtail (9")     |
| E13-MS0R-1                          | Silho-X 2.75" Round Warm White/Red Combo Light SS Trim Ring  |   | 20       | Pigtail (9")     |
| E13-RB10-1                          | Silho-X 2.75" Round LP Red Light - Black Trim Ring           |   | 20       | Pigtail (9")     |
| E13-RW10-1                          | Silho-X 2.75" Round LP Red Light - White Trim Ring           |   | 20       | Pigtail (9")     |
| E13-WB10-1                          | Silho-X 2.75" Round White Light Plastic Trim Ring Black      |   | 20       | Pigtail (9")     |
| E13-WS00-1                          | Silho-X 2.75" Round White Light SS Trim Ring                 |   | 20       | Pigtail (9")     |
| E13-WS0F-1                          | Silho-X 2.75" Round White Light Diffuse Lens SS Trim Ring    |   | 20       | Pigtail (9")     |
| E13-WS0R-1                          | Silho-X 2.75" Round White/Red Combo Light SS Trim Ring       |   | 20       | Pigtail (9")     |
| E13-WW10-1                          | Silho-X 2.75" Round LP White Light - White Trim Ring         |   | 20       | Pigtail (9")     |
| <b>E16 - High Output Dome Light</b> |  |   |          |                  |
| E16-LB00-1                          | E16 Interior SM Neutral White Oval Light Black Base          |   | 20       | Sheathed Pigtail |
| E16-LBS0-1                          | E16 Interior SM Neutral White Oval Light Black Base w/Switch |   | 20       | Sheathed Pigtail |
| E16-LW00-1                          | E16 Interior SM Neutral White Oval Light White Base          |   | 20       | Sheathed Pigtail |
| E16-LWS0-1                          | E16 Interior SM Neutral White Oval Light White Base w/Switch |   | 20       | Sheathed Pigtail |
| E16-MB00-1                          | E16 Interior SM Warm White Oval Light Black Base             |   | 20       | Sheathed Pigtail |

| Part No.   | Part Description  |   | Std Pack | Connector        |
|--|---|---|----------|------------------|
| E16-MBS0-1   | E16 Interior SM Warm White Oval Light Black Base w/Switch             |       | 20       | Sheathed Pigtail |
| E16-MW00-1   | E16 Interior SM Warm White Oval Light White Base                      |       | 20       | Sheathed Pigtail |
| E16-MWS0-1   | E16 Interior SM Warm White Oval Light White Base w/Switch             |       | 20       | Sheathed Pigtail |
| E16-WB00-1   | E16 Interior SM White Oval Light Black Base                           |       | 20       | Sheathed Pigtail |
| E16-WBS0-1   | E16 Interior SM White Oval Light Black Base w/Switch                  |       | 20       | Sheathed Pigtail |
| E16-WW00-1   | E16 Interior SM White Oval Light White Base                           |       | 20       | Sheathed Pigtail |
| E16-WWS0-1   | E16 Interior SM White Oval Light White Base w/Switch                  |       | 20       | Sheathed Pigtail |
| <b>E18 - 4.5" Utility Light</b>                    |   |   |          |                  |
| E18-LC00-1   | 12 LED Neutral White Dome Light                                       |       | 10       | Sheathed Pigtail |
| E18-LCS0-1   | 12 LED Neutral White Dome Light with Switch                           |       | 10       | Sheathed Pigtail |
| E18-LCSB-1   | 12 LED Neutral White Dome Light with Switch & .180 Bullets            |       | 10       | Sheathed Pigtail |
| E18-WC00-1   | 12 LED White Dome Light   |       | 10       | Sheathed Pigtail |
| E18-WCS0-1   | 12 LED White Dome Light with switch                                   |       | 10       | Sheathed Pigtail |
| <b>E20 - Orion Series Surface Mount Dome Light</b> |   |   |          |                  |
| E20-LA00-1   | 6" Interior Light Neutral White Aluminum Trim Ring                    |       | 5        | Pigtail (15")    |
| E20-LA03-1   | Orion Int. Lt. Tri-Level Intensity Neutral White Aluminum Trim Ring   |       | 5        | Pigtail (15")    |
| E20-LA0R-1   | 6" interior Light Neutral White/Red Aluminum Trim Ring                |       | 5        | Pigtail (15")    |
| E20-LC00-1   | 6" Interior Light Neutral White Chrome Trim Ring                      |       | 5        | Pigtail (15")    |
| E20-LC0R-1   | 6" interior Light Neutral White/Red Combo Chrome Trim Ring            |     | 5        | Pigtail (15")    |
| E20-LC0RF-1  | 6" interior Light Neutral White/Red Combo Chrome Trim Ring w xTM06-3S |   | 5        | Pigtail (15")    |
| E20-MA00-1   | 6" Interior Light Warm White Aluminum Trim Ring                       |   | 5        | Pigtail (15")    |
| E20-MA03-1   | Orion Int. Lt. Tri-Level Intensity Warm White Aluminum Trim Ring      |   | 5        | Pigtail (15")    |
| E20-MA0R-1   | 6" interior Light Warm White/Red Combo Aluminum Trim Ring             |   | 5        | Pigtail (15")    |
| E20-MC00-1   | 6" Interior Light Warm White Chrome Trim Ring                         |   | 5        | Pigtail (15")    |
| E20-WC00-1   | 6" Interior Light White Chrome Trim Ring                              |   | 5        | Pigtail (15")    |
| E20-WC0R-1   | 6" Interior Light White/Red Combo Chrome Trim Ring                    |   | 5        | Pigtail (15")    |
| E20-WCB0-1   | 6" Interior Light White/Blue Combo Chrome Trim Ring                   |   | 5        | Pigtail (15")    |
| <b>E22 - Motion Sensor Control Unit</b>            |   |   |          |                  |
| E22-XB00-1   | Interior Motion Sensor Light Controller Black                         |   | TBD      | Pigtail (9")     |
| E22-XW00-1   | Interior Motion Sensor Light Controller White                         |   | TBD      | Pigtail (9")     |
| <b>E25 - 3" Spring Mounted Dome Light</b>          |   |   |          |                  |
| E25-L000-1   | 3in Spring Mounted Dome Light Neutral White                           |   | 10       | Sheathed Pigtail |
| E25-L0S0-1   | 3in Spring Mounted Dome Light Neutral White w/ Switch                 |   | 10       | Sheathed Pigtail |
| E25-M000-1   | 3in Spring Mounted Dome Light Warm White                              |   | 10       | Sheathed Pigtail |
| E25-M0S0-1   | 3in Spring Mounted Dome Light Warm White w/ Switch                    |   | 10       | Sheathed Pigtail |
| E25-W000-1   | 3in Spring Mounted Dome Light Cool White                              |   | 10       | Sheathed Pigtail |
| E25-W0S0-1   | 3in Spring Mounted Dome Light Cool White w/ Switch                    |   | 10       | Sheathed Pigtail |
| <b>E26 - 4.5" Spring Mounted Dome Light</b>        |   |   |          |                  |
| E26-L000-1   | 4.5in Spring Mounted Dome Light Neutral White                         |   | 10       | Sheathed Pigtail |









| Part No.   | Part Description   |   | Std Pack | Connector                     |
|--|--|---|----------|-------------------------------|
| E26-LOS0-1   | Spring Mounted Dome Light Neutral White w/ Switch            |       | 10       | Sheathed Pigtail              |
| E26-LP00-1   | 4.5 in Spring Mounted Premium Dome Light Neutral White       |       | 10       | Sheathed Pigtail              |
| E26-LPS0-1   | 4.5" Spring Mounted Premium Dome Light Neut White w/ Switch  |       | 10       | Sheathed Pigtail              |
| E26-M000-1   | 4.5in Spring Mounted Dome Light Warm White                   |       | 10       | Sheathed Pigtail              |
| E26-M0S0-1   | 5in Spring Mounted Dome Light Warm White w/ Switch           |       | 10       | Sheathed Pigtail              |
| E26-MP00-1   | 4.5in Spring Mounted Premium Dome Light Warm White           |       | 10       | Sheathed Pigtail              |
| E26-MPS0-1   | 4.5 in Spring Mounted Premium Dome Light Warm White w/Switch |       | 10       | Sheathed Pigtail              |
| E26-W000-1   | 4.5in Spring Mounted Dome Light Cool White                   |       | 10       | Sheathed Pigtail              |
| E26-W0S0-1   | 5in Spring Mounted Dome Light Cool White w/ Switch           |       | 10       | Sheathed Pigtail              |
| E26-WP00-1   | 4.5in Spring Mounted Premium Dome Light Cool White           |       | 10       | Sheathed Pigtail              |
| E26-WPS0-1   | 4.5" Spring Mounted Premium Dome Light Cool White w/ Switch  |       | 10       | Sheathed Pigtail              |
| <b>E27 - 3" Surface Mounted Dome Light</b>           |  |   |          |                               |
| E27-L000-1   | 3" Surface Mounted Dome Light Neutral White                  |       | 10       | Sheathed Pigtail              |
| E27-M000-1   | 3" Surface Mounted Dome Light Warm White                     |       | 10       | Sheathed Pigtail              |
| E27-W000-1   | 3" Surface Mounted Dome Light Cool White                     |       | 10       | Sheathed Pigtail              |
| <b>E28 - 4.5" Surface Mounted Dome Light</b>         |  |   |          |                               |
| E28-L000-1   | 4.5" Surface Mounted Dome Light Neutral White                |       | 10       | Sheathed Pigtail              |
| E28-LOS0-1   | 4.5" Surface Mounted Dome Light Neutral White w/ Switch      |       | 10       | Sheathed Pigtail              |
| E28-LP00-1   | 4.5" Surface Mounted Premium Dome Light Neutral White        |       | 10       | Sheathed Pigtail              |
| E28-LP0B-1   | 4.5" SM Premium Dome Light Neutral White w 180 Bullets       |   | 10       | Sheathed Pigtail / 0.180" Bul |
| E28-LPS0-1   | 4.5" Surface Mounted Premium Dome Light Neut White w/ Switch |   | 10       | Sheathed Pigtail              |
| E28-LPW00-1  | 4.5" Surface Mounted Premium Dome Light Neu White White Ring |   | 10       | Sheathed Pigtail              |
| E28-M000-1   | 4.5" Surface Mounted Dome Light Warm White                   |   | 10       | Sheathed Pigtail              |
| E28-M0S0-1   | 4.5" Surface Mounted Dome Light Warm White w/ Switch         |   | 10       | Sheathed Pigtail              |
| E28-MP00-1   | 4.5" Surface Mounted Premium Dome Light Warm White           |   | 10       | Sheathed Pigtail              |
| E28-MPS0-1   | 4.5" Surface Mounted Premium Dome Light Warm White w/Switch  |   | 10       | Sheathed Pigtail              |
| E28-W000-1   | 4.5" Surface Mounted Dome Light Cool White                   |   | 10       | Sheathed Pigtail              |
| E28-W0S0-1   | 4.5" Surface Mounted Dome Light Cool White w/ Switch         |   | 10       | Sheathed Pigtail              |
| E28-WP00-1   | 4.5" Surface Mounted Premium Dome Light Cool White           |   | 10       | Sheathed Pigtail              |
| E28-WPS0-1   | 4.5" Surface Mounted Premium Dome Light Cool White w/ Switc  |   | 10       | Sheathed Pigtail              |
| <b>E30 - High Performance Recessed Ceiling Light</b> |  |   |          |                               |
| E30-L000-1   | Recessed 4K White 42 LED Light 6"x17.5"                      |   | 12       | Pigtail (12")                 |
| E30-L00M-1   | Recessed 4K White 42 LED Light 6"x17.5" w/Motion Detection   |   | 12       | Pigtail (12")                 |
| E30-L00R-1   | Recessed 4K White/Red 42/16 LED Light 6"x17.5"               |   | 12       | Pigtail (12")                 |
| E30-L010-1   | Recessed 4K White 21 LED Light 6"x17.5"                      |   | 12       | Pigtail (12")                 |
| E30-L01R-1   | Recessed 4K White/Red 21/16 LED Light 6"x17.5"               |   | 12       | Pigtail (12")                 |
| E30-LOS0-1   | Recessed 4K White 42 LED Light 6"x17.5" Switched             |   | 12       | Pigtail (12")                 |
| E30-LOSR-1   | Recessed 4K White/Red 42/16 LED Light 6"x17.5" Switched      |   | 12       | Pigtail (12")                 |
| E30-L1S0-1   | Recessed 4K White 21 LED Light 6"x17.5" Switched             |   | 12       | Pigtail (12")                 |











| Part No.   | Part Description  |  | Std Pack | Connector            |
|--|---|--|----------|----------------------|
| E30-L1SR-1   | Recessed 4K White/Red 21/16 LED Light 6"x17.5" Switched                             |  | 12       | Pigtail (12")        |
| E30-W000-1   | Recessed 5K White 42 LED Light 6"x17.5"   |  | 12       | Pigtail (12")        |
| E30-W00M-1   | Recessed 5K White 42 LED Light 6"x17.5" w/Motion Detection                          |  | 12       | Pigtail (12")        |
| E30-W00R-1   | Recessed 5K White/Red 42/16 LED Light 6"x17.5"                                      |  | 12       | Pigtail (12")        |
| E30-W010-1   | Recessed 5K White 21 LED Light 6"x17.5"   |  | 12       | Pigtail (12")        |
| E30-W01R-1   | Recessed 5K White/Red 21/16 LED Light 6"x17.5"                                      |  | 12       | Pigtail (12")        |
| E30-W0S0-1   | Recessed 5K White 42 LED Light 6"x17.5" Switched                                    |  | 12       | Pigtail (12")        |
| E30-W0SR-1   | Recessed 5K White/Red 42/16 LED Light 6"x17.5" Switched                             |  | 12       | Pigtail (12")        |
| E30-W1S0-1   | Recessed 5K White 21 LED Light 6"x17.5" Switched                                    |  | 12       | Pigtail (12")        |
| E30-W1SR-1   | Recessed 5K White/Red 21/16 LED Light 6"x17.5" Switched                             |  | 12       | Pigtail (12")        |
| <b>E31 - High Performance Recessed Ceiling Light</b> |   |  |          |                      |
| E31-L00B-1   | Recessed 4K White 32 LED Light 6"x17.5"   |  | 12       | Pigtail (6")         |
| E31-L0MB-1   | Recessed 4K White 32 LED Light 6"x17.5" Motion Detection                            |  | 12       | Pigtail (6")         |
| E31-L0MS-1   | Recessed 4K White 32 LED Light 6"x17.5" Motion Detection w/ Spade Connector         |  | 12       | Pigtail (6")         |
| <b>E32 - Surface Mounted Ceiling Light</b>           |   |  |          |                      |
| E32-L000-1   | Interior 4K White 42 LED Surface Mount Light  |  | 10       | Pigtail (12")        |
| E32-L00M-1   | Interior 4K White 42 LED Surface Mount Light W/MD                                   |  | 10       | Pigtail (12")        |
| E32-L00S-1   | Interior 4K White 42 LED Surface Mount Light W/Switch                               |  | 10       | Pigtail (12")        |
| <b>E33 - Recessed Ceiling Light</b>                  |   |  |          |                      |
| E33-L00B-1   | Recessed 4K White 32 LED Light 6"x17.5" w 180 Bullets Plastic Base                  |  | 12       | Pigtail / 0.180" Bul |
| E33-L0MB-1   | Recessed 4K White 32 LED Light 6"x17.5" Motion Detection w 180 Bullets Plastic Base |  | 12       | Pigtail / 0.180" Bul |
| <b>E34 - 3/4" Grommet Mount Step Accent Lights</b>   |   |  |          |                      |
| E34-BB00-1   | Blue Step Accent Light Black Cover  |  | 100      | Sheathed Pigtail     |
| E34-BC00-1   | Blue Step Accent Light Chrome Cover   |  | 100      | Sheathed Pigtail     |
| E34-RB00-1   | Red Step Accent Light Black Cover   |  | 100      | Sheathed Pigtail     |
| E34-RC00-1   | Red Step Accent Light Chrome Cover  |  | 100      | Sheathed Pigtail     |
| E34-WB00-1   | White Step Accent Light Black Cover   |  | 100      | Sheathed Pigtail     |
| E34-WC00-1   | White Step Accent Light Chrome Cover  |  | 100      | Sheathed Pigtail     |
| <b>E35/E36/E38 - Linear Area Light</b>               |   |  |          |                      |
| E35-LB00-1   | Linear LED SM Light Neutral White Black Body 9W                                     |  | 20       | Sheathed Pigtail     |
| E35-LB0S-1   | Linear LED SM Light Neutral White Black Body 9W w/Switch                            |  | 20       | Sheathed Pigtail     |
| E35-MB00-1   | Linear LED SM Light Warm White Black Body 9W  |  | 20       | Sheathed Pigtail     |
| E35-WB00-1   | Linear LED SM Light White Black Body 9W   |  | 20       | Sheathed Pigtail     |
| E35-WB0S-1   | Linear LED SM Light White Black Body 9W w/Switch                                    |  | 20       | Sheathed Pigtail     |
| E35-WB24-1   | Linear LED SM Light White Black Body 9W 24V   |  | 20       | Sheathed Pigtail     |
| E36-LB00-1   | Linear LED SM Light Neutral White Black Body 18W                                    |  | 20       | Sheathed Pigtail     |
| E36-LB0S-1   | LED SM Light Neutral White Black Body 18W w/Switch                                  |  | 20       | Sheathed Pigtail     |
| E36-LB24-1   | Linear LED SM Light Neutral White Black Body 18W 24V                                |  | 20       | Sheathed Pigtail     |
| E36-MB00-1   | Linear LED SM Light Warm White Black Body 18W                                       |  | 20       | Sheathed Pigtail     |

| Part No.   | Part Description  |   | Std Pack | Connector        |
|------------|---|---|----------|------------------|
| E36-WB00-1 | Linear LED SM Light White Black Body 18W                  |   | 20       | Sheathed Pigtail |
| E36-WB0S-1 | Linear LED SM Light White Black Body 18W w/Switch         |   | 20       | Sheathed Pigtail |
| E36-WB24-1 | Linear LED SM Light White Black Body 18W 24V              |   | 20       | Sheathed Pigtail |
| E38-LB00-1 | Linear LED SM Light Neutral White Black Body 36W          |   | 10       | Sheathed Pigtail |
| E38-LB0S-1 | Linear LED SM Light Neutral White Black Body 36W w/Switch |   | 10       | Sheathed Pigtail |
| E38-LB24-1 | Linear LED SM Light Neutral White Black Body 36W 24V      |   | 10       | Sheathed Pigtail |
| E38-MB00-1 | Linear LED SM Light Warm White Black Body 36W             |   | 10       | Sheathed Pigtail |
| E38-WB00-1 | Linear LED SM Light White Black Body 36W                  |   | 10       | Sheathed Pigtail |
| E38-WB0S-1 | Linear LED SM Light White Black Body 36W w/Switch         |   | 10       | Sheathed Pigtail |
| E38-WB24-1 | Linear LED SM Light White Black Body 36W 24V              |   | 10       | Sheathed Pigtail |

### E39 - Fluorescent Replacement Kit

|            |  |   |    |         |
|------------|--|---|----|---------|
| E39-L000-1 | LED Neutral White Light Replacement Kit for P716 and P718    |   | 10 | Pigtail |
| E39-L00R-1 | LED Neutral White/Red Combo Light Repl Kit for P716 and P718 |   | 10 | Pigtail |
| E39-L010-1 | LED Neutral White Light Replacement Kit for 712XL            |   | 10 | Pigtail |

















### E41 - Flexible Weather Resistant Lighting Strips

|            |   |   |   |   |
|------------|---|---|---|---|
| E41-000V-1 | 2 wire termination                      |   | - | - |
| E41-A010-1 | Flexible LED Light Amber 4.5" - No Wire |       | - | - |
| E41-B010-1 | Flexible LED Light Blue 4.5" - No Wire  |       | - | - |
| E41-G010-1 | Flexible LED Light Green 4.5" - No Wire |       | - | - |
| E41-R010-1 | Flexible LED Light Red 4.5" - No Wire   |   | - | - |
| E41-W010-1 | Flexible LED Light White 4.5" - No Wire |   | - | - |

Available in custom length sections from 4.5" - 16.5'

\*4.5" Increments only

### E44 - Flexible Weather Resistant Lighting Strips

|            |   |   |   |                                   |
|------------|---|---|---|-----------------------------------|
| E44-000V-1 | 2 wire termination  |   | - | -                                 |
| E44-304X-1 | Water Resistant Flexible LED Light RGB Reel 18" Dual Wire |   | - | Sheathed Pigtail<br>(18") 2-sided |
| E44-3010-1 | Flexible LED Light RGB 4.5" - No Wire                     |   | - | -                                 |
| E44-330V-1 | Water Resistant Flexible LED Light RGB135"                |   | - | -                                 |
| E44-A010-1 | Flexible LED Light Amber 4.5" - No Wire                   |   | - | -                                 |
| E44-B010-1 | Flexible LED Light Blue 4.5" - No Wire                    |   | - | -                                 |
| E44-G010-1 | Flexible LED Light Green 4.5" - No Wire                   |   | - | -                                 |
| E44-R010-1 | Flexible LED Light Red 4.5" - No Wire                     |   | - | -                                 |
| E44-W010-1 | Flexible LED Light White 4.5" - No Wire                   |   | - | -                                 |







Available in custom length sections from 4.5" - 16.5'

\*4.5" Increments only

### E45 - Slim Light

|            |   |  |   |   |
|------------|---|--|---|---|
| E45-0B03-1 | Black Parallel Mount Screw Clip - Pair      |  | - | - |
| E45-0B04-1 | Black Perpendicular Mount Screw Clip - Pair |  | - | - |
| E45-0B05-1 | Black 45 Degree Mount Screw Clip - Pair     |  | - | - |



| Part No.     | Part Description  |   | Std Pack | Connector     |
|--------------|---|---|----------|---------------|
| E45-4B050-1  | 9.5" Aluminum Extrusion Lamp RGBW Black Housing                                     |  ○ | -        | -             |
| E45-4B070-1  | 12.5" Aluminum Extrusion Lamp RGBW Black Housing                                    |  ○ | -        | -             |
| E45-4B130-1  | 21.5" Aluminum Extrusion Lamp RGBW Black Housing                                    |  ○ | -        | -             |
| E45-4B230-1  | 36" Aluminum Extrusion Lamp RGBW Black Housing                                      |  ○ | -        | -             |
| E45-4B300-1  | 47" Aluminum Extrusion Lamp RGBW Black Housing                                      |  ○ | -        | -             |
| E45-4B460-1  | 71" Aluminum Extrusion Lamp RGBW Black Housing                                      |  ○ | -        | -             |
| E45-4B560-1  | 86" Aluminum Extrusion Lamp RGBW Black Housing                                      |  ○ | -        | -             |
| E45-W010-1   | 3 LED 7" Aluminum Extrusion Lamp White Black Housing                                | □ ○   | -        | -             |
| E45-W010W-1  | 3 LED 7" Aluminum Extrusion Lamp White Black Housing With M/F Connector             | □ ○   | -        | M/F Connector |
| E45-W010X-1  | 3 LED 7" Aluminum Extrusion Lamp White Black Housing W/Dual Wire                    | □ ○   | -        | Dual Pigtail  |
| E45-W010Y-1  | 3 LED 7" Aluminum Extrusion Lamp White Black Housing W/F-Connector                  | □ ○   | -        | F Connector   |
| E45-W010Z-1  | 3 LED 7" Aluminum Extrusion Lamp White Black Housing With M-Connector               | □ ○   | -        | M Connector   |
| E45-W020-1   | 6 LED 11.5" Aluminum Extrusion Lamp White Black Housing                             | □ ○   | -        | -             |
| E45-W020W-1  | 6 LED 11.5" Aluminum Extrusion Lamp White Black Housing With M/F Connector          | □ ○   | -        | M/F Connector |
| E45-W020X-1  | 6 LED 11.5" Aluminum Extrusion Lamp White Black Housing W/Dual Wire                 | □ ○   | -        | Dual Pigtail  |
| E45-W020Y-1  | 6 LED 11.5" Aluminum Extrusion Lamp White Black Housing W/F-Connector               | □ ○   | -        | F Connector   |
| E45-W020Z-1  | 6 LED 11.5" Aluminum Extrusion Lamp White Black Housing With M-Connector            | □ ○   | -        | M Connector   |
| E45-W050-1   | 15 LED 25" Aluminum Extrusion Lamp White Black Housing                              | □ ○   | -        | -             |
| E45-W050W-1  | 15 LED 25" Aluminum Extrusion Lamp White Black Housing With M/F Connector           | □ ○   | -        | M/F Connector |
| E45-W050X-1  | 15 LED 25" Aluminum Extrusion Lamp White Black Housing W/Dual Wire                  | □ ○   | -        | Dual Pigtail  |
| E45-W050Y-1  | 15 LED 25" Aluminum Extrusion Lamp White Black Housing W/F-Connector                | □ ○   | -        | F Connector   |
| E45-W050Z-1  | 15 LED 25" Aluminum Extrusion Lamp White Black Housing With M-Connector             | □ ○   | -        | M Connector   |
| E45-W080-1   | 24 LED 38.5" Aluminum Extrusion Lamp White Black Housing                            | □ ○   | -        | -             |
| E45-W080X-1  | 24 LED 38.5" Aluminum Extrusion Lamp White Black Housing dual wires                 | □ ○   | -        | -             |
| E45-W100-1   | 30 LED 47.5" Aluminum Extrusion Lamp White Black Housing                            | □ ○   | -        | -             |
| E45-W100W-1  | 30 LED 47.5" Aluminum Extrusion Lamp White Black Housing With M/F Connector         | □ ○   | -        | M/F Connector |
| E45-W100X-1  | 30 LED 47.5" Aluminum Extrusion Lamp White Black Housing W/Dual Wire                | □ ○   | -        | Dual Pigtail  |
| E45-W100Y-1  | 30 LED 47.5" Aluminum Extrusion Lamp White Black Housing W/F-Connector              | □ ○   | -        | F Connector   |
| E45-W100Z-1  | 30 LED 47.5" Aluminum Extrusion Lamp White Black Housing With M-Connector           | □ ○   | -        | M Connector   |
| E45-W120X-1  | 36 LED 57in Aluminum White Light  | □ ○   | -        | Dual Pigtail  |
| E45-WBP01-1  | 6 LED Premium 7" Aluminum Extrusion Lamp White Black Housing                        | □ ○   | -        | -             |
| E45-WBP01W-1 | 6 LED Premium 7" Aluminum Extrusion Lamp White Black Housing With M/F Connector     | □ ○   | -        | M/F Connector |
| E45-WBP01X-1 | 6 LED Premium 7" Aluminum Extrusion Lamp White Black Housing W/Dual Wire            | □ ○   | -        | Dual Pigtail  |
| E45-WBP01Y-1 | 6 LED Premium 7" Aluminum Extrusion Lamp White Black Housing With F-Connector       | □ ○   | -        | F Connector   |
| E45-WBP01Z-1 | 6 LED Premium 7" Aluminum Extrusion Lamp White Black Housing With M-Connector       | □ ○   | -        | M Connector   |
| E45-WBP02-1  | 12 LED Premium 11.5" Aluminum Extrusion Lamp White Black Housing                    | □ ○   | -        | -             |
| E45-WBP02W-1 | 12 LED Premium 11.5" Aluminum Extrusion Lamp White Black Housing With M/F Connector | □ ○   | -        | M/F Connector |
| E45-WBP02X-1 | 12 LED Premium 11.5" Aluminum Extrusion Lamp White Black Housing W/Dual Wire        | □ ○   | -        | Dual Pigtail  |
| E45-WBP02Y-1 | 12 LED Premium 11.5" Aluminum Extrusion Lamp White Black Housing With F-Connector   | □ ○   | -        | F Connector   |

| Part No.     | Part Description  |  | Std Pack | Connector     |
|--------------|---|--|----------|---------------|
| E45-WBP02Z-1 | 12 LED Premium 11.5" Aluminum Extrusion Lamp White Black Housing With M-Connector   |  | -        | M Connector   |
| E45-WBP05-1  | 30 LED Premium 25" Aluminum Extrusion Lamp White Black Housing                      |  | -        | -             |
| E45-WBP05W-1 | 30 LED Premium 25" Aluminum Extrusion Lamp White Black Housing With M/F Connector   |  | -        | M/F Connector |
| E45-WBP05X-1 | 30 LED Premium 25" Aluminum Extrusion Lamp White Black Housing W/Dual Wire          |  | -        | Dual Pigtail  |
| E45-WBP05Y-1 | 30 LED Premium 25" Aluminum Extrusion Lamp White Black Housing With F-Connector     |  | -        | F Connector   |
| E45-WBP05Z-1 | 30 LED Premium 25" Aluminum Extrusion Lamp White Black Housing With M-Connector     |  | -        | M Connector   |
| E45-WBP08-1  | 48 LED Premium 38.5" Aluminum Extrusion Lamp White Black Housing                    |  | -        | -             |
| E45-WBP10-1  | 60 LED Premium 47.5" Aluminum Extrusion Lamp White Black Housing                    |  | -        | -             |
| E45-WBP10W-1 | 60 LED Premium 47.5" Aluminum Extrusion Lamp White Black Housing With M/F Connector |  | -        | M/F Connector |
| E45-WBP10X-1 | 60 LED Premium 47.5" Aluminum Extrusion Lamp White Black Housing W/Dual Wire        |  | -        | Dual Pigtail  |
| E45-WBP10Y-1 | 60 LED Premium 47.5" Aluminum Extrusion Lamp White Black Housing With F-Connector   |  | -        | F Connector   |
| E45-WBP10Z-1 | 60 LED Premium 47.5" Aluminum Extrusion Lamp White Black Housing With M-Connector   |  | -        | M Connector   |
| E45-WBP12-1  | 72 LED Premium 56.5" Aluminum Extrusion Lamp White                                  |  | -        | -             |
| E45-WBP12X-1 | 72 LED Premium 57" Aluminum Extrusion Lamp White Black Housing w/ Dual Wire         |  | -        | Dual Pigtail  |

**E46 - Water Resistant LED Flexible LED Light**

|             |  |  |   |   |
|-------------|--|--|---|---|
| E46-402V-1  | Water resistant Flexible LED Light RGBW 4.5" w/ 5C wire  |  | - | - |
| E46-403V-1  | Water Resistant Flexible LED Light RGBW 6" with 5C wire  |  | - | - |
| E46-407V-1  | Water Resistant Flexible LED Light RGBW 12" with 5C wire |  | - | - |
| E46-410V-1  | Water resistant Flexible LED Light RGBW 16.5" w/ 5C wire |  | - | - |
| E46-413V-1  | Water Resistant Flexible LED Light RGBW 21" with 5C wire |  | - | - |
| E46-419V-1  | Water Resistant Flexible LED Light RGBW 30" with 5C wire |  | - | - |
| E46-422V-1  | Water Resistant Flexible LED Light RGBW 34.5" with       |  | - | - |
| E46-423V-1  | Water Resistant Flexible LED Light RGBW 36" with 5C wire |  | - | - |
| E46-436V-1  | Water resistant Flexible LED Light RGBW 55.5" w/ 5C wire |  | - | - |
| E46-447V-1  | Water resistant Flexible LED Light RGBW 72" w/ 5C wire   |  | - | - |
| E46-448VS-1 | Flexible LED Light RGBW 73.5" with 5C shrink-wrapp       |  | - | - |

























**E47 -Wide Body Diffuse RGB Strip Light**

|             |  |  |   |   |
|-------------|--|--|---|---|
| E47-0W01-1  | E47 Extruded Mounting Strip 72"              |  | - | - |
| E47-3D040-1 | Wide Body Diffuse RGB Strip Light 14in       |  | - | - |
| E47-3D14V-1 | Wide Body Diffuse RGB Strip Light 14in w VHB |  | - | - |
| E47-3D310-1 | Wide Body Diffuse RGB Strip Light 31"        |  | - | - |
| E47-3D31V-1 | Wide Body Diffuse RGB Strip Light 31in w VHB |  | - | - |
| E47-3D360-1 | Wide Body Diffuse RGB Strip Light 36in       |  | - | - |
| E47-3D55V-1 | Wide Body Diffuse RGB Strip Light 55in w VHB |  | - | - |

**E48 - Ultra Thin Diffuse Strip Light**

|             |  |  |   |   |
|-------------|--|--|---|---|
| E48-0W01-1  | Ultra Thin Strip Light Mounting Channel 36in |  | - | - |
| E48-0W02-1  | Ultra Thin Strip Light Mounting Channel 72"  |  | - | - |
| E48-3D04L-1 | Ultra Thin Diffuse Strip Light 4in w LH Wire |  | - | - |
| E48-3D04R-1 | Ultra Thin Diffuse Strip Light 4in w RH Wire |  | - | - |

Index

| Part No.                                      | Part Description   |   | Std Pack | Connector              |
|---|--|---|----------|------------------------|
| E48-3D06LF-1                                  | Ultra Thin Diffuse Strip Light 6in w LH Wire and ATM06-4S  |  ○   | -        | -                      |
| E48-3D06R-1                                   | Ultra Thin Diffuse Strip Light 6in w RH Wire               |  ○   | -        | -                      |
| E48-3D08L-1                                   | Ultra Thin Diffuse Strip Light 8in w LH Wire               |  ○   | -        | -                      |
| E48-3D12R-1                                   | Ultra Thin Diffuse Strip Light 12in w RH Wire              |  ○   | -        | -                      |
| E48-3D12RF-1                                  | Ultra Thin Diffuse Strip Light 12in w RH Wire and ATM06-4S |  ○   | -        | -                      |
| E48-3D16L-1                                   | Ultra Thin Diffuse Strip Light 16in w LH Wire              |  ○   | -        | -                      |
| E48-3D16R-1                                   | Ultra Thin Diffuse Strip Light 16in w RH Wire              |  ○   | -        | -                      |
| E48-3D40L-1                                   | Ultra Thin Diffuse Strip Light 40in w LH Wire              |  ○   | -        | -                      |
| E48-3D40LF-1                                  | Ultra Thin Diffuse Strip Light 40in w LH Wire and ATM06-4S |  ○   | -        | -                      |
| E48-3D40R-1                                   | Ultra Thin Diffuse Strip Light 40in w RH Wire              |  ○   | -        | -                      |
| E48-3D40RF-1                                  | Ultra Thin Diffuse Strip Light 40in w RH Wire and ATM06-4S |  ○   | -        | -                      |
| E48-3D45L-1                                   | Ultra Thin Diffuse Strip Light 45in w LH Wire              |  ○   | -        | -                      |
| E48-3D45LF-1                                  | Ultra Thin Diffuse Strip Light 45in w LH Wire and ATM06-4S |  ○   | -        | -                      |
| E48-3D45R-1                                   | Ultra Thin Diffuse Strip Light 45in w RH Wire              |  ○   | -        | -                      |
| E48-3D45RF-1                                  | Ultra Thin Diffuse Strip Light 45in w RH Wire and ATM06-4S |  ○   | -        | -                      |
| E48-3D55L-1                                   | Ultra Thin Diffuse Strip Light 55in w LH Wire              |  ○   | -        | -                      |
| E48-3D55LF-1                                  | Ultra Thin Diffuse Strip Light 55in w LH Wire and ATM06-4S |  ○   | -        | -                      |
| E48-3D55R-1                                   | Ultra Thin Diffuse Strip Light 55in w RH Wire              |  ○   | -        | -                      |
| E48-3D55RF-1                                  | Ultra Thin Diffuse Strip Light 55in w RH Wire and ATM06-4S |  ○   | -        | -                      |
| <b>E49 - Rigid Black Aluminum Strip Light</b> |  |   |          |                        |
| E49-0B05-1                                    | E49 Black Powder Coated Parallel Mounting Clips - Pair     |   | -        | -                      |
| E49-BWB20-1                                   | Blue White Rigid Black Alu Strip Light 24in                |  ○ | -        | Sheathed Pigtail (12") |
| E49-BWB20-K                                   | Blue White Rigid Black Alu Strip Light 24in w Clips        |  ○ | -        | Sheathed Pigtail (12") |
| E49-BWB30-1                                   | Blue White Rigid Black Alu Strip Light 36in                |  ○ | -        | Sheathed Pigtail (12") |
| E49-BWB30-K                                   | Blue White Rigid Black Alu Strip Light 36in w Clips        |  ○ | -        | Sheathed Pigtail (12") |
| E49-BWB40-1                                   | Blue White Rigid Black Alu Strip Light 48in                |  ○ | -        | Sheathed Pigtail (12") |
| E49-BWB40-K                                   | Blue White Rigid Black Alu Strip Light 48in w Clips        |  ○ | -        | Sheathed Pigtail (12") |
| E49-WB20-1                                    | White Rigid Black Alu Strip Ligth 24"                      |  ○ | -        | Sheathed Pigtail (24") |
| E49-WB30-1                                    | White Rigid Black Alu Strip Ligth 36"                      |  ○ | -        | Sheathed Pigtail (36") |
| E49-WB40-1                                    | White Rigid Black Alu Strip Ligth 48"                      |  ○ | -        | Sheathed Pigtail (48") |
| <b>E50 - Round Surface Mount Dome Light</b>   |  |   |          |                        |
| E50-LC00-1                                    | 4.5" Round Interior Lamp 12 LED No Switch Neutral LED      |  ○ | 20       | Pigtail (8")           |
| E50-LCS0-1                                    | 4.5" Round Interior Lamp 12 LED With Switch Neutral LED    |  ○ | 20       | Pigtail (8")           |
| E50-MC00-1                                    | 4.5" Round Interior Lamp 12 LED No Switch                  |  ○ | 20       | Pigtail (8")           |
| E50-MCS0-1                                    | 4.5" Round Interior Lamp 12 LED With Switch                |  ○ | 20       | Pigtail (8")           |
| E50-WC00-1                                    | 4.5" Round Interior Lamp 12 LED No Switch Cool LED         |  ○ | 20       | Pigtail (8")           |
| E50-WCS0-1                                    | 4.5" Round Interior Lamp 12 LED With Switch Cool LED       |  ○ | 20       | Pigtail (8")           |
| <b>E51 - Oval Surface Mount Dome Light</b>    |  |   |          |                        |
| E51-LC00-1                                    | 4.5" Round Interior Lamp 12 LED No Switch Neutral LED      |  ○ | 20       | Pigtail (8")           |



































































| Part No.  | Part Description   |   | Std Pack | Connector              |
|---|--|---|----------|------------------------|
| E51-LCS0-1  | 4.5" Round Interior Lamp 12 LED With Switch Neutral LED                  |       | 20       | Pigtail (8")           |
| E51-MC00-1  | 6" x 3.5" Oval Interior Lamp 12 LED No Switch                            |       | 20       | Pigtail (8")           |
| E51-MCS0-1  | 6" x 3.5" Oval Interior Lamp 12 LED With Switch                          |       | 20       | Pigtail (8")           |
| E51-WC00-1  | 6" x 3.5" Oval Interior Lamp 12 LED No Switch Cool LED                   |       | 20       | Pigtail (8")           |
| E51-WCS0-1  | 6" x 3.5" Oval Interior Lamp 12 LED With Switch Cool LED                 |       | 20       | Pigtail (8")           |
| <b>E57 -Wide Body Diffuse Strip Light</b>                           |  |   |          |                        |
| E57-4D060-1   | Wide Body Diffuse RGBW Strip Light 6in                                   |       | TBD      | 9" Pigtail             |
| E57-4D120-1   | Wide Body Diffuse RGBW Strip Light 12in                                  |       | TBD      | 9" Pigtail             |
| E57-4D330-1   | Wide Body Diffuse RGBW Strip Light 33in                                  |       | TBD      | 9" Pigtail             |
| E57-4D680-1   | Wide Body Diffuse RGBW Strip Light 68in                                  |       | TBD      | 9" Pigtail             |
| <b>E58 -Narrow Body Diffuse Strip Light</b>                         |  |   |          |                        |
| E58-4D060-1   | Narrow Body Diffuse RGBW Strip Light 6in                                 |       | TBD      | 9" Pigtail             |
| E58-4D120-1   | Narrow Body Diffuse RGBW Strip Light 12in                                |       | TBD      | 9" Pigtail             |
| E58-4D330-1   | Narrow Body Diffuse RGBW Strip Light 33in                                |       | TBD      | 9" Pigtail             |
| <b>E60 - Trailer/Marine LED Recessed Mount Spotlight - One Pair</b> |  |   |          |                        |
| E60-WS20-1  | E60 Through Hull Docking Light Dual Intensity                            |       | 6 Pairs  | Sheathed Pigtail (12") |
| <b>E61 - Trailer/Marine LED Surface Mount Spotlight - One Pair</b>  |  |   |          |                        |
| E61-WS00-1  | Surface Mount Docking Light  |       | 6 Pairs  | Sheathed Pigtail (12") |
| E61-WS0E-1  | Surface Mount Docking Light W/Metri-Pack Connector                       |       | 6 Pairs  | Metri-Pack Connector   |
| E61-WS0F-1  | Surface Mount Docking Light w xT04-2P Connector                          |   | 6 Pairs  | xT04-2P                |
| <b>E96 - Trailer/Marine LED Surface Mount Spotlight - One Pair</b>  |  |   |          |                        |
| E96-WS00-1  | Docking Light TecNiq   |   | 12       | 9" Pigtail             |
| <b>E99 - Dimmer Switches</b>  |  |   |          |                        |
| E99-D001-1  | Dimmer Rotary  |   | -        | -                      |
| E99-D002-1  | Dimmer Slide   |   | -        | -                      |
| <b>E100 - High Intensity Scene Light</b>                            |  |   |          |                        |
| E100-0BR32-1  | E100 Brow Mount Brackets Black w/ 3.2" Radius.                           |   | -        | -                      |
| E100-0PMKB-1  | E100 Pole Mount Kit Black  |   | -        | -                      |
| E100-0PMKW-1  | E100 Pole Mount Kit White  |   | -        | -                      |
| E100-1C00-1   | High Int Scene Light Chrome Ring   |   | -        | -                      |
| E100-WB00-1   | High Int Scene Light 12/24V dc Sf Mt Black Housing                       |   | -        | Pigtail (12")          |
| E100-WB0F-1   | High Intensity Scene Light 12/24Vdc SM Black Housing w/ xTP04-2P         |   | -        | Deutsch (12")          |
| E100-WBP0-1   | High Intensity Scene Light 12/24Vdc Pole Mount Black Housing             |   | -        | Pigtail (12")          |
| E100-WBPF-1   | High Intensity Scene Light 12/24Vdc Pole Mount Black Housing w/ xTP04-2P |   | -        | Deutsch (12")          |
| E100-WW00-1   | High Int Scene Light 12/24V dc Sf Mt white housing                       |   | -        | Pigtail (12")          |
| E100-WW0F-1   | High Intensity Scene Light 12/24Vdc SM White Housing w/ xTP04-2P         |   | -        | Deutsch (12")          |
| E100-WWP0-1   | High Intensity Scene Light 12/24vdc Pole Mount White Housing             |   | -        | Pigtail (12")          |
| E100-WWPF-1   | High Intensity Scene Light 12/24Vdc Pole Mount White Housing w/ xTP04-2P |   | -        | Deutsch (12")          |
| E100-WXPX-1   | High Int Scene Light 12/24V dc Sf Mt white housing Pole Mount            |   | -        | Pigtail (12")          |







































































| Part No.                                    | Part Description   |  | Std Pack | Connector    |
|---|--|--|----------|--------------|
| <b>J00 - Vent Cover</b>                     |  |  |          |              |
| J00-0B00-1                                  | Exterior Vent Cover Black  |  | 1        | -            |
| J00-0B01-1                                  | Interior Circular Vent Cover Black   |  | 1        | -            |
| J00-0W00-1                                  | Exterior Vent Cover White  |  | 1        | -            |
| J00-0W01-1                                  | Interior Circular Vent Cover White   |  | 1        | -            |
| J01-0B00-1                                  | Injection Molded Wiring Box  |  | -        | -            |
| J05-0B00-1                                  | Marine Speaker Cover - Black   |  | -        | -            |
| J05-WBHD-1                                  | Marine Speaker Cover Light w/Harness & Weatherpack   |  | -        | -            |
| J07-0B00-1                                  | Wire Harness Cover   |  | -        | -            |
| <b>K10 - Flashing Beacon</b>                |  |  |          |              |
| K10-0CB0-1                                  | K10 Chrome Brush Guard   |  | 1        | -            |
| K10-AA0P-1                                  | K10 Amber Beacon Light Amber Lens Single Flash Pattern W/Pigtail                                 |  | 1        | 8.5" Pigtail |
| K10-AAAD-1                                  | K10 Amber Beacon Light Amber Lens Single Flash Pattern W/Pigtail Deutsch Connector & Brush Guard |  | 1        | 8.5" Deutsch |
| K10-AADP-1                                  | Amber Beacon Light Amber Lens Autosync Multi-Flash Pattern W/Pigtail                             |  | 1        | 8.5" Pigtail |
| K10-AGDP-1                                  | Amber Green Dual Color Beacon Light Autosync Multi-Flash Pattern w/ Pigtail                      |  | 1        | 8.5" Pigtail |
| K10-AWDP-1                                  | Amber White Dual Color Beacon Light Autosync Multi-Flash Pattern w/ Pigtail                      |  | 1        | 8.5" Pigtail |
| K10-BCDP-1                                  | Blue Beacon Light Clear Lens Autosync Multi-Flash Pattern W/ Pigtail                             |  | 1        | 8.5" Pigtail |
| K10-GCDP-1                                  | Green Beacon Light Clear Lens Autosync Multi-Flash Pattern W/Pigtail                             |  | 1        | 8.5" Pigtail |
| K10-RCDP-1                                  | Red Beacon Light Clear Lens Autosync Multi-Flash Pattern W/ Pigtail                              |  | 1        | 8.5" Pigtail |
| K10-RR0P-1                                  | Red Beacon Light Red Lens Single Flash Pattern W/ Pigtail  |  | 1        | 8.5" Pigtail |
| K10-RRDP-1                                  | Red Beacon Light Red Lens Autosync Multi-Flash Pattern W/ Pigtail                                |  | 1        | 8.5" Pigtail |
| <b>K20 - High Visibility Stop/Tail/Turn</b> |  |  |          |              |
| K20-AAA0-1                                  | 7in Round Amber Arrow Flasher Lamp Amber Lens  |  | 15       | 8.3" Pigtail |
| K20-AAS0-1                                  | Steady 7in Round Amber Flasher Lamp Amber Lens   |  | 15       | 8.3" Pigtail |
| K20-AAT0-1                                  | Steady 7in Round Amber Turn Amber Lens   |  | 15       | 8.3" Pigtail |
| K20-RRS0-1                                  | Steady 7in Round Red Flasher Lamp Red Lens   |  | 15       | 8.3" Pigtail |
| K20-STR0-1                                  | Steady 7in Round Red STT Red Lens  |  | 15       | 8.3" Pigtail |
| K20-WBU0-1                                  | Steady 7in Round White Backup Lamp   |  | 15       | 8.3" Pigtail |
| <b>K30 - Grille Light</b>                   |  |  |          |              |
| K30-0S02-1                                  | K30 3 LED Trim Ring SS   |  | -        | -            |
| K30-0S09-1                                  | K30 6 LED Trim Ring SS   |  | -        | -            |
| K30-0S14-1                                  | K30 12 LED Trin Ring SS  |  | -        | -            |
| K30-AA030-1                                 | Amber Grille Flasher 3 LED Amber Lens  |  | 80       | 12" Pigtail  |
| K30-AA060-1                                 | Amber Grille Flasher 6 LED Amber Lens  |  | 100      | 12" Pigtail  |
| K30-AA120-1                                 | Amber Grille Flasher 12 LED Amber Lens   |  | 40       | 12" Pigtail  |
| K30-AAS30-1                                 | K30 3 LED Steady Burn Flasher Amber Lens   |  | 80       | 12" Pigtail  |
| K30-AAS60-1                                 | Amber Grill Steady Flasher 6 LED Amber Lens  |  | 100      | 12" Pigtail  |
| K30-AB060-1                                 | Amber/Blue Dual (Split) Color Grille Flasher 6 LED Clear Lens                                    |  | 100      | 12" Pigtail  |
| K30-AB120-1                                 | Amber/Blue Dual (Split) Color Grille Flasher 12 LED Clear Lens                                   |  | 40       | 12" Pigtail  |

| Part No.    | Part Description  |  | Std Pack | Connector   |
|-------------|---|--|----------|-------------|
| K30-AC030-1 | Amber Grille Flasher 3 LED Clear Lens                           |  | 80       | 12" Pigtail |
| K30-AC03B-1 | Amber Grill Flasher 3 LED Programmable Clear Len                |  | 80       | 12" Pigtail |
| K30-AC060-1 | Amber Grille Flasher 6 LED Clear Lens                           |  | 100      | 12" Pigtail |
| K30-AC120-1 | Amber Grille Flasher 12 LED Clear Lens                          |  | 40       | 12" Pigtail |
| K30-ACS30-1 | K30 3 LED Amber Steady Burn Flasher Clear Lens                  |  | 80       | 12" Pigtail |
| K30-ACS60-1 | Amber Grill Steady Flasher 6 LED Clear Lens                     |  | 100      | 12" Pigtail |
| K30-AG060-1 | Amber/Green Dual (Split) Color Grille Flasher 6 LED Clear Lens  |  | 100      | 12" Pigtail |
| K30-AG120-1 | Amber/Green Dual (Split) Color Grille Flasher 12 LED Clear Lens |  | 40       | 12" Pigtail |
| K30-AR060-1 | Amber/Red Dual (Split) Color Grille Flasher 6 LED Clear Lens    |  | 100      | 12" Pigtail |
| K30-AR120-1 | Amber/Red Dual (Split) Color Grille Flasher 12 LED Clear Lens   |  | 40       | 12" Pigtail |
| K30-AW060-1 | Amber/White Dual (Split) Color Grille Flasher 6 LED Clear Lens  |  | 100      | 12" Pigtail |
| K30-AW120-1 | Amber/White Dual (Split) Color Grille Flasher 12 LED Clear Lens |  | 40       | 12" Pigtail |
| K30-BB030-1 | Blue Grille Flasher 3 LED Blue Lens                             |  | 80       | 12" Pigtail |
| K30-BB060-1 | Blue Grille Flasher 6 LED Blue Lens                             |  | 100      | 12" Pigtail |
| K30-BB120-1 | Blue Grille Flasher 12 LED Blue Lens                            |  | 40       | 12" Pigtail |
| K30-BC030-1 | Blue Grille Flasher 3 LED Clear Lens                            |  | 80       | 12" Pigtail |
| K30-BC060-1 | Blue Grille Flasher 6 LED Clear Lens                            |  | 100      | 12" Pigtail |
| K30-BC120-1 | Blue Grille Flasher 12 LED Clear Lens                           |  | 40       | 12" Pigtail |
| K30-BCS30-1 | K30 3 LED Blue Steady Burn Flasher Clear Lens                   |  | 80       | 12" Pigtail |
| K30-BCS60-1 | Blue Grill Steady Flasher 6 LED Clear Lens                      |  | 100      | 12" Pigtail |
| K30-BR060-1 | Blue/Red Dual (Split) Color Grille Flasher 6 LED Clear Lens     |  | 100      | 12" Pigtail |
| K30-BW060-1 | Blue/White Dual (Split) Color Grille Flasher 6 LED Clear Lens   |  | 100      | 12" Pigtail |
| K30-BW120-1 | Blue/White Dual (Split) Color Grille Flasher 12 LED Clear Lens  |  | 40       | 12" Pigtail |
| K30-GC030-1 | Green Grille Flasher 3 LED Clear Lens                           |  | 80       | 12" Pigtail |
| K30-GC060-1 | Green Grille Flasher 6 LED Clear Lens                           |  | 100      | 12" Pigtail |
| K30-GC120-1 | Green Grille Flasher 12 LED Clear Lens                          |  | 40       | 12" Pigtail |
| K30-GCS30-1 | K30 3 LED Green Steady Burn Flasher Clear Lens                  |  | 80       | 12" Pigtail |
| K30-GCS60-1 | Green Grill Steady Flasher 6 LED Clear Lens                     |  | 100      | 12" Pigtail |
| K30-GG030-1 | Green Grille Flasher 3 LED Green Lens                           |  | 80       | 12" Pigtail |
| K30-GG060-1 | Green Grille Flasher 6 LED Green Lens                           |  | 100      | 12" Pigtail |
| K30-GG120-1 | Green Grille Flasher 12 LED Green Lens                          |  | 40       | 12" Pigtail |
| K30-GR060-1 | Green/Red Dual (Split) Color Grille Flasher 6 LED Clear Lens    |  | 100      | 12" Pigtail |
| K30-GR120-1 | Green/Red Dual (Split) Color Grille Flasher 12 LED Clear Lens   |  | 40       | 12" Pigtail |
| K30-GW060-1 | Green/White Dual (Split) Color Grille Flasher 6 LED Clear       |  | 100      | 12" Pigtail |
| K30-GW060-1 | Green/White Dual (Split) Color Grille Flasher 6 LED Clear Lens  |  | 100      | 12" Pigtail |
| K30-GW120-1 | Green/White Dual (Split) Color Grille Flasher 12 LED Clear Lens |  | 40       | 12" Pigtail |
| K30-RC030-1 | Red Grille Flasher 3 LED Clear Lens                             |  | 80       | 12" Pigtail |
| K30-RC060-1 | Red Grille Flasher 6 LED Clear Lens                             |  | 100      | 12" Pigtail |
| K30-RC120-1 | Red Grille Flasher 12 LED Clear Lens                            |  | 40       | 12" Pigtail |



| Part No.                              | Part Description   |  | Std Pack | Connector   |
|---------------------------------------|--|--|----------|-------------|
| K30-RCS30-1                           | K30 3 LED Red Steady Burn Flasher Clear Lens   |  | 80       | 12" Pigtail |
| K30-RCS60-1                           | Red Grill Steady Flasher 6 LED Clear Lens  |  | 100      | 12" Pigtail |
| K30-RR030-1                           | Red Grille Flasher 3 LED Red Lens  |  | 80       | 12" Pigtail |
| K30-RR060-1                           | Red Grille Flasher 6 LED Red Lens  |  | 100      | 12" Pigtail |
| K30-RR120-1                           | Red Grille Flasher 12 LED Red Lens   |  | 40       | 12" Pigtail |
| K30-RRS30-1                           | K30 3 LED Red Steady Burn Flasher Red Lens   |  | 80       | 12" Pigtail |
| K30-RRS60-1                           | K30 6 LED Red Steady Burn Flasher Red Lens   |  | 100      | 12" Pigtail |
| K30-RW060-1                           | Red/White Dual (Split) Color Grille Flasher 6 LED Clear Lens                             |  | 100      | 12" Pigtail |
| K30-RW120-1                           | Red/White Dual (Split) Color Grille Flasher 12 LED Clear Lens                            |  | 40       | 12" Pigtail |
| K30-WC030-1                           | White Grille Flasher 3 LED Clear Lens  |  | 80       | 12" Pigtail |
| K30-WC060-1                           | White Grille Flasher 6 LED Clear Lens  |  | 100      | 12" Pigtail |
| K30-WC120-1                           | White Grille Flasher 12 LED Clear Lens   |  | 40       | 12" Pigtail |
| K30-WCS30-1                           | K30 3 LED Steady Burn Flasher  |  | 80       | 12" Pigtail |
| K30-WCS60-1                           | White Grill Steady Flasher 6 LED Clear Lens  |  | 100      | 12" Pigtail |
| <b>K40 5"x 3.3" Emergency Flasher</b> |  |  |          |             |
| K40-0100-1                            | K40 K50 Anchor Screw Kit   |  | 1        | -           |
| K40-1B00-1                            | K40 Black Trim and Gasket Kit  |  | 1        | -           |
| K40-1C00-1                            | K40 Chrome Trim and Gasket Kit   |  | 1        | -           |
| K40-AA00-1                            | K40 AutoSync Amber Flasher Lamp Amber Lens   |  | 1        | Pigtail     |
| K40-AAS0-1                            | K40 Steady Amber Flasher Lamp Amber Lens   |  | 1        | Pigtail     |
| K40-AC00-1                            | K40 AutoSync Amber Flasher Lamp Clear Lens   |  | 1        | Pigtail     |
| K40-ACS0-1                            | K40 Steady Amber Flasher Lamp Clear Lens   |  | 1        | Pigtail     |
| K40-AR00-1                            | K40 AutoSync Amber Red Combo Flasher Lamp Clear Lens                                     |  | 1        | Pigtail     |
| K40-BA00-1                            | K40 AutoSync Blue Amber Combo Flasher Lamp Clear Lens                                    |  | 1        | Pigtail     |
| K40-BB00-1                            | K40 AutoSync Blue Flasher Lamp Blue Lens   |  | 1        | Pigtail     |
| K40-BBS0-1                            | K40 Steady Blue Flasher Lamp Blue Lens   |  | 1        | Pigtail     |
| K40-BC00-1                            | K40 AutoSync Blue Flasher Lamp Clear Lens  |  | 1        | Pigtail     |
| K40-BCS0-1                            | K40 Steady Blue Flasher Lamp Clear Lens  |  | 1        | Pigtail     |
| K40-BR00-1                            | K40 AutoSync Blue Red Combo Flasher Lamp Clear Lens                                      |  | 1        | Pigtail     |
| K40-GC00-1                            | K40 AutoSync Green Flasher Lamp Clear Lens   |  | 1        | Pigtail     |
| K40-GCS0-1                            | K40 Steady Green Flasher Lamp Clear Lens   |  | 1        | Pigtail     |
| K40-GG00-1                            | K40 AutoSync Green Flasher Lamp Green Lens <i>*Please contact us for min. quantities</i> |  | 1        | Pigtail     |
| K40-GGS0-1                            | K40 Steady Green Flasher Lamp Green Lens <i>*Please contact us for min. quantities</i>   |  | 1        | Pigtail     |
| K40-RC00-1                            | K40 AutoSync Red Flasher Lamp Clear Lens   |  | 1        | Pigtail     |
| K40-RCS0-1                            | K40 Steady Red Flasher Lamp Clear Lens   |  | 1        | Pigtail     |
| K40-RR00-1                            | K40 AutoSync Red Flasher Lamp Red Lens   |  | 1        | Pigtail     |
| K40-RRS0-1                            | K40 Steady Red Flasher Lamp Red Lens   |  | 1        | Pigtail     |
| K40-WA00-1                            | K40 AutoSync White Amber Combo Flasher Lamp Clear Lens                                   |  | 1        | Pigtail     |
| K40-WB00-1                            | K40 AutoSync White Blue Combo Flasher Lamp Clear Lens                                    |  | 1        | Pigtail     |

| Part No.                            | Part Description                                       |   | Std Pack | Connector |
|-------------------------------------|--|---|----------|-----------|
| K40-WC00-1                          | K40 AutoSync White Flasher Lamp Clear Lens             |       | 1        | Pigtail   |
| K40-WCS0-1                          | K40 Steady White Flasher Lamp Clear Lens               |       | 1        | Pigtail   |
| K40-WR00-1                          | K40 AutoSync White Red Combo Flasher Lamp Clear Lens   |       | 1        | Pigtail   |
| <b>K50 5"x 2" Emergency Flasher</b> |  |   |          |           |
| K50-1B00-1                          | K50 Black Trim and Gasket Kit                          |   | 1        | -         |
| K50-1C00-1                          | K50 Chrome Trim and Gasket Kit                         |   | 1        | -         |
| K50-AA00-1                          | K50 AutoSync Amber Flasher Lamp Amber Lens             |       | 1        | Pigtail   |
| K50-AAS0-1                          | K50 Steady Amber Flasher Lamp Amber Lens               |       | 1        | Pigtail   |
| K50-AC00-1                          | K50 AutoSync Amber Flasher Lamp Clear Lens             |       | 1        | Pigtail   |
| K50-ACS0-1                          | K50 Steady Amber Flasher Lamp Clear Lens               |       | 1        | Pigtail   |
| K50-AG00-1                          | K50 AutoSync Amber Green Combo Flasher Lamp Clear Lens |       | 1        | Pigtail   |
| K50-AR00-1                          | K50 AutoSync Amber Red Combo Flasher Lamp Clear Lens   |       | 1        | Pigtail   |
| K50-BA00-1                          | K50 AutoSync Blue Amber Combo Flasher Lamp Clear Lens  |       | 1        | Pigtail   |
| K50-BB00-1                          | K50 AutoSync Blue Flasher Lamp Blue Lens               |       | 1        | Pigtail   |
| K50-BBS0-1                          | K50 Steady Blue Flasher Lamp Blue Lens                 |       | 1        | Pigtail   |
| K50-BC00-1                          | K50 AutoSync Blue Flasher Lamp Clear Lens              |       | 1        | Pigtail   |
| K50-BCS0-1                          | K50 Steady Blue Flasher Lamp Clear Lens                |       | 1        | Pigtail   |
| K50-BR00-1                          | K50 AutoSync Blue Red Combo Flasher Lamp Clear Lens    |       | 1        | Pigtail   |
| K50-GC00-1                          | K50 AutoSync Green Flasher Lamp Clear Lens             |       | 1        | Pigtail   |
| K50-GCS0-1                          | K50 Steady Green Flasher Lamp Clear Lens               |   | 1        | Pigtail   |
| K50-GG00-1                          | K50 AutoSync Green Flasher Lamp Green Lens             |   | 1        | Pigtail   |
| K50-GGS0-1                          | K50 Steady Green Flasher Lamp Green Lens               |   | 1        | Pigtail   |
| K50-RC00-1                          | K50 AutoSync Red Flasher Lamp Clear Lens               |   | 1        | Pigtail   |
| K50-RCS0-1                          | K50 Steady Red Flasher Lamp Clear Lens                 |   | 1        | Pigtail   |
| K50-RR00-1                          | K50 AutoSync Red Flasher Lamp Red Lens                 |   | 1        | Pigtail   |
| K50-RRS0-1                          | K50 Steady Red Flasher Lamp Red Lens                   |   | 1        | Pigtail   |
| K50-WA00-1                          | K50 AutoSync White Amber Combo Flasher Lamp Clear Lens |   | 1        | Pigtail   |
| K50-WB00-1                          | K50 AutoSync White Blue Combo Flasher Lamp Clear Lens  |   | 1        | Pigtail   |
| K50-WC00-1                          | K50 AutoSync White Flasher Lamp Clear Lens             |   | 1        | Pigtail   |
| K50-WCS0-1                          | K50 Steady White Flasher Lamp Clear Lens               |   | 1        | Pigtail   |
| K50-WR00-1                          | K50 AutoSync White Red Combo Flasher Lamp Clear Lens   |   | 1        | Pigtail   |
| <b>K60 6"x 4" Emergency Flasher</b> |  |   |          |           |
| K60-0C40-1                          | K60 Quad Bezel Chromed                                 |   | 1        | -         |
| K60-1B00-1                          | K60 Black Trim and Gasket Kit                          |   | 1        | -         |
| K60-1C00-1                          | K60 Chrome Trim and Gasket Kit                         |   | 1        | -         |
| K60-A3S0-1                          | K60 Steady Amber Turn Amber Lens Arrow Mask            |   | 1        | Pigtail   |
| K60-AA00-1                          | K60 AutoSync Amber Flasher Lamp Amber Lens             |   | 1        | Pigtail   |
| K60-AAA0-1                          | K60 AutoSync Amber Flasher Lamp Amber Lens Arrow Mask  |   | 1        | Pigtail   |
| K60-AAS0-1                          | K60 Steady Amber Flasher Amber Lens                    |   | 1        | Pigtail   |

| Part No.                            | Part Description   |   | Std Pack | Connector |
|-------------------------------------|--|---|----------|-----------|
| K60-AAT0-1                          | K60 Steady Amber Turn Amber Lens   |       | 1        | Pigtail   |
| K60-AC00-1                          | K60 AutoSync Amber Flasher Lamp Clear Lens   |       | 1        | Pigtail   |
| K60-ACA0-1                          | K60 AutoSync Amber Flasher Lamp Clear Lens Arrow Mask                                    |       | 1        | Pigtail   |
| K60-ACAS0-1                         | K60 Steady Amber Turn Clear Lens Arrow Mask  |       | 1        | Pigtail   |
| K60-ACS0-1                          | K60 Steady Amber Flasher Clear Lens  |       | 1        | Pigtail   |
| K60-ACT0-1                          | K60 Steady Amber Turn Clear Lens   |       | 1        | Pigtail   |
| K60-BB00-1                          | K60 AutoSync Blue Flasher Lamp Blue Lens   |       | 1        | Pigtail   |
| K60-BBS0-1                          | K60 Steady Blue Flasher Blue Lens  |       | 1        | Pigtail   |
| K60-BC00-1                          | K60 AutoSync Blue Flasher Lamp Clear Lens  |       | 1        | Pigtail   |
| K60-BCS0-1                          | K60 Steady Blue Flasher Clear Lens   |       | 1        | Pigtail   |
| K60-GC00-1                          | K60 AutoSync Green Flasher Lamp Clear Lens   |       | 1        | Pigtail   |
| K60-GCS0-1                          | K60 Steady Green Flasher Clear Lens  |       | 1        | Pigtail   |
| K60-GG00-1                          | K60 AutoSync Green Flasher Lamp Green Lens <i>*Please contact us for min. quantities</i> |       | 1        | Pigtail   |
| K60-GGS0-1                          | K60 Steady Green Flasher Green Lens <i>*Please contact us for min. quantities</i>        |       | 1        | Pigtail   |
| K60-RC00-1                          | K60 AutoSync Red Flasher Lamp Clear Lens   |       | 1        | Pigtail   |
| K60-RCS0-1                          | K60 Steady Red Flasher Clear Lens  |       | 1        | Pigtail   |
| K60-RR00-1                          | K60 AutoSync Red Flasher Lamp Red Lens   |       | 1        | Pigtail   |
| K60-RRS0-1                          | K60 Steady Red Flasher Red Lens  |       | 1        | Pigtail   |
| K60-STC0-1                          | K60 Steady Red STT Clear Lens  |       | 1        | Pigtail   |
| K60-STR0-1                          | K60 Steady Red STT Red Lens  |   | 1        | Pigtail   |
| K60-SW00-1                          | K60 Scene Light  |   | 1        | Pigtail   |
| K60-WBU0-1                          | K60 White Backup Lamp  |   | 1        | Pigtail   |
| K60-WC00-1                          | K60 AutoSync White Flasher Lamp  |   | 1        | Pigtail   |
| K60-WCS0-1                          | K60 Steady White Flasher Clear Lens  |   | 1        | Pigtail   |
| <b>K70 7"x 3" Emergency Flasher</b> |  |   |          |           |
| K70-0100-1                          | K60 & K70 Anchor/Screw Kit   |   | 1        | -         |
| K70-1B00-1                          | K70 Black Trim and Gasket Kit  |   | 1        | -         |
| K70-1C00-1                          | K70 Chrome Trim and Gasket Kit   |   | 1        | -         |
| K70-AA00-1                          | K70 AutoSync Amber Flasher Lamp Amber Lens   |   | 1        | Pigtail   |
| K70-AAS0-1                          | K70 Steady Amber Flasher Amber Lens  |   | 1        | Pigtail   |
| K70-AAT0-1                          | K70 Steady Amber Turn Amber Lens   |   | 1        | Pigtail   |
| K70-AC00-1                          | K70 AutoSync Amber Flasher Lamp Clear Lens   |   | 1        | Pigtail   |
| K70-ACS0-1                          | K70 Steady Amber Flasher Clear Lens  |   | 1        | Pigtail   |
| K70-ACT0-1                          | K70 Steady Amber Turn Clear Lens   |   | 1        | Pigtail   |
| K70-BB00-1                          | K70 AutoSync Blue Flasher Lamp Blue Lens   |   | 1        | Pigtail   |
| K70-BBS0-1                          | K70 Steady Blue Flasher Blue Lens  |   | 1        | Pigtail   |
| K70-BC00-1                          | K70 AutoSync Blue Flasher Lamp Clear Lens  |   | 1        | Pigtail   |
| K70-BCS0-1                          | K70 Steady Blue Flasher Clear Lens   |   | 1        | Pigtail   |
| K70-GC00-1                          | K70 AutoSync Green Flasher Lamp Clear Lens   |   | 1        | Pigtail   |







| Part No.                           | Part Description   |  | Std Pack | Connector |
|------------------------------------|--|--|----------|-----------|
| K70-GCS0-1                         | K70 Steady Green Flasher Clear Lens  |  | 1        | Pigtail   |
| K70-GG00-1                         | K70 AutoSync Green Flasher Lamp Green Lens <i>*Please contact us for min. quantities</i> |  | 1        | Pigtail   |
| K70-GGS0-1                         | K70 Steady Green Flasher Green Lens <i>*Please contact us for min. quantities</i>        |  | 1        | Pigtail   |
| K70-RC00-1                         | K70 AutoSync Red Flasher Lamp Clear Lens   |  | 1        | Pigtail   |
| K70-RCS0-1                         | K70 Steady Red Flasher Clear Lens  |  | 1        | Pigtail   |
| K70-RR00-1                         | K70 AutoSync Red Flasher Lamp Red Lens   |  | 1        | Pigtail   |
| K70-RRS0-1                         | K70 Steady Red Flasher Red Lens  |  | 1        | Pigtail   |
| K70-STC0-1                         | K70 Steady Red STT Clear Lens  |  | 1        | Pigtail   |
| K70-STR0-1                         | K70 Steady Red STT Red Lens  |  | 1        | Pigtail   |
| K70-SW00-1                         | K70 High Output Scene Light  |  | 1        | Pigtail   |
| K70-WBU0-1                         | K70 White Backup Lamp  |  | 1        | Pigtail   |
| K70-WC00-1                         | K70 AutoSync White Flasher Lamp  |  | 1        | Pigtail   |
| K70-WCS0-1                         | K70 Steady White Flasher Clear Lens  |  | 1        | Pigtail   |
| <b>K90 9"x7" Emergency Flasher</b> |  |  |          |           |
| K90-0100-1                         | K90 Anchor/Screw Kit   |  | 1        | -         |
| K90-1B00-1                         | K90 Black Trim and Gasket Kit  |  | 1        | -         |
| K90-1C00-1                         | K90 Chrome Trim and Gasket Kit   |  | 1        | -         |
| K90-AA00-1                         | K90 AutoSync Amber Amber Flasher Lamp Amber Lens   |  | 1        | Pigtail   |
| K90-AAS0-1                         | K90 Steady Amber Amber Flasher Lamp Amber Lens   |  | 1        | Pigtail   |
| K90-AAT0-1                         | K90 Steady Amber Turn Amber Lens   |  | 1        | Pigtail   |
| K90-AC00-1                         | K90 AutoSync Amber Amber Flasher Lamp Clear Lens   |  | 1        | Pigtail   |
| K90-ACS0-1                         | K90 Steady Amber Amber Flasher Lamp Clear Lens   |  | 1        | Pigtail   |
| K90-ACT0-1                         | K90 Steady Amber Turn Clear Lens   |  | 1        | Pigtail   |
| K90-AS00-1                         | K90 AutoSync Amber Flasher Lamp With Scene Lens  |  | 1        | Pigtail   |
| K90-ASS0-1                         | K90 Steady Amber Scene Lamp Clear Lens   |  | 1        | Pigtail   |
| K90-AW00-1                         | K90 AutoSync Amber White Flasher Lamp Clear Lens   |  | 1        | Pigtail   |
| K90-BB00-1                         | K90 AutoSync Blue Blue Flasher Lamp Blue Lens  |  | 1        | Pigtail   |
| K90-BBS0-1                         | K90 Steady Blue Blue Flasher Lamp Blue Lens  |  | 1        | Pigtail   |
| K90-BBU0-1                         | K90 Blue Backup Lamp   |  | 1        | Pigtail   |
| K90-BC00-1                         | K90 AutoSync Blue Blue Flasher Lamp Clear Lens   |  | 1        | Pigtail   |
| K90-BCS0-1                         | K90 Steady Blue Blue Flasher Lamp Clear Lens   |  | 1        | Pigtail   |
| K90-BS00-1                         | K90 AutoSync Blue Scene Flasher Lamp Clear Lens  |  | 1        | Pigtail   |
| K90-GC00-1                         | K90 AutoSync Green Green Flasher Lamp Clear Lens   |  | 1        | Pigtail   |
| K90-GCS0-1                         | K90 Steady Green Flasher Lamp Clear Lens   |  | 1        | Pigtail   |
| K90-GG00-1                         | K90 AutoSync Green Flasher Lamp Green Lens <i>*Please contact us for min. quantities</i> |  | 1        | Pigtail   |
| K90-GGS0-1                         | K90 Steady Green Flasher Lamp Green Lens <i>*Please contact us for min. quantities</i>   |  | 1        | Pigtail   |
| K90-R0SC0-1                        | K90 Red AutoSync Top STT Bottom Clear Lens   |  | 1        | Pigtail   |
| K90-RA00-1                         | K90 AutoSync Red Amber Flasher Lamp Clear Lens   |  | 1        | Pigtail   |
| K90-RAS0-1                         | K90 Steady Red Amber Flasher Lamp Clear Lens   |  | 1        | Pigtail   |







































































| Part No.   | Part Description  |  | Std Pack | Connector |
|------------|---|--|----------|-----------|
| K90-RB00-1 | K90 AutoSync Red Blue Flasher Lamp Clear Lens           |  | 1        | Pigtail   |
| K90-RBS0-1 | K90 Steady Red Blue Flasher Lamp Clear Lens             |  | 1        | Pigtail   |
| K90-RC00-1 | K90 AutoSync Red Red Flasher Lamp Clear Lens            |  | 1        | Pigtail   |
| K90-RCS0-1 | K90 Steady Red Red Flasher Lamp Clear Lens              |  | 1        | Pigtail   |
| K90-RR00-1 | K90 AutoSync Red Red Flasher Lamp Red Lens              |  | 1        | Pigtail   |
| K90-RRS0-1 | K90 Steady Red Red Flasher Lamp Red Lens                |  | 1        | Pigtail   |
| K90-RS00-1 | K90 AutoSync Red Scene Flasher Lamp Clear Lens          |  | 1        | Pigtail   |
| K90-RSS0-1 | K90 Steady Red Scene Lamp Clear Lens                    |  | 1        | Pigtail   |
| K90-RW00-1 | K90 AutoSync Red White Flasher Lamp Clear Lens          |  | 1        | Pigtail   |
| K90-RWS0-1 | K90 Steady Red White Flasher Lamp Clear Lens            |  | 1        | Pigtail   |
| K90-STAO-1 | K90 Steady Red STT Top Amber Autosync Bottom Clear Lens |  | 1        | Pigtail   |
| K90-STC0-1 | K90 Steady Red STT Clear Lens                           |  | 1        | Pigtail   |
| K90-STR0-1 | K90 Steady Red STT Red Lens                             |  | 1        | Pigtail   |
| K90-STS0-1 | K90 Steady Red STT Bottom Scene Clear Lens              |  | 1        | Pigtail   |
| K90-SW00-1 | K90 High Output Scene Light                             |  | 1        | Pigtail   |
| K90-SW00-K | K90 High Output Scene Light W/Chrome Trim Ring          |  | 1        | Pigtail   |
| K90-WA00-1 | K90 AutoSync White Amber Flasher Lamp Clear Lens        |  | 1        | Pigtail   |
| K90-WB00-1 | K90 AutoSync White Blue Flasher Lamp Clear Lens         |  | 1        | Pigtail   |
| K90-WBS0-1 | K90 Steady White Blue Flasher Lamp Clear Lens           |  | 1        | Pigtail   |
| K90-WBU0-1 | K90 White Backup Lamp                                   |  | 1        | Pigtail   |
| K90-WC00-1 | K90 AutoSync White White Flasher Lamp Clear Lens        |  | 1        | Pigtail   |
| K90-WCS0-1 | K90 Steady White White Flasher Lamp Clear Lens          |  | 1        | Pigtail   |
| K90-WR00-1 | K90 AutoSync White Red Flasher Lamp Clear Lens          |  | 1        | Pigtail   |

Other Combinations Available. Call for Details



































| Lxx - License Plate Lamp |  |  |    |                        |
|--------------------------|--|--|----|------------------------|
| L10-0G00-1               | License Lamp Gasket  |  | 10 | -                      |
| L10-WB00-1               | Black Base License Lamp Vertical Plane Mount   |  | 10 | Sheathed Pigtail       |
| L10-WB0D-1               | License Lamp Vertical Plane Mount 21.5" wire w/ Delphi Con.  |  | 10 | Delphi Connector       |
| L10-WB0G-1               | Black Base License Lamp Vertical Plane Mount with 9" black wire, 2.5" white wire & #10 ground ring |  | 10 | Pigtail w/ Ground Ring |
| L10-WB9B-1               | Black Base License Lamp Vertical Plane Mount w/.180 Bullet   |  | 10 | 0.180" Bullets         |
| L10-WB9M-1               | Black Base License Lamp Vertical Plane Mount W/.156 Bullet   |  | 10 | 0.156" Bullets         |
| L10-WC00-1               | Chrome Base License Lamp Vertical Plane Mount  |  | 10 | Sheathed Pigtail       |
| L10-WC0F-1               | Chrome Base License Lamp Vertical Plane Mount w xT06-2S Connector                                  |  | 10 | T06-2S Connector       |
| L10-WC9B-1               | Chrome Base License Lamp Vertical Plane Mount w/.180 bullet  |  | 10 | Sheathed Pigtail       |
| L11-WB00-1               | Black Base License Lamp Vertical Plane Mount   |  | 10 | Sheathed Pigtail       |
| L11-WB0F-1               | Black Base License Lamp Vertical Plane Mount w/ATM06-2S conn                                       |  | 10 | ATM06-2S               |
| L11-WB0G-1               | Black Base License Lamp Vertical Plane Mount W/ 9" wires & 1/4" Ground Ring                        |  | 10 | Pigtail w/ Ground Ring |
| L11-WB1B-1               | Black Base License Lamp Vertical Plane Mount 13" Wires w 180 Bullets                               |  | 10 | 0.180" Bullets         |
| L11-WB9B-1               | Black Base License Lamp Vertical Plane Mount w/.180" Bullets                                       |  | 10 | 0.180" Bullets         |





















































| Part No.  | Part Description  |   | Std Pack      | Connector        |
|---|---|---|---------------|------------------|
| L11-WB9N-1  | Black Base License Lamp Vertical Plane Mount w/.156" Barrels        | <input type="checkbox"/> <input type="radio"/>  | 10            | 0.156" Barrels   |
| L11-WC00-1  | Chrome Base License Lamp Vertical Plane Mount                       | <input type="checkbox"/> <input type="radio"/>  | 10            | Sheathed Pigtail |
| L11-WC9B-1  | Chrome Base License Lamp V-Plane Mount w/.180" Bullets              | <input type="checkbox"/> <input type="radio"/>  | 10            | 0.180" Bullets   |
| L11-WC9M-1  | Chrome Base License Lamp Vertical Plane Mount W/.156 Bullets        | <input type="checkbox"/> <input type="radio"/>  | 10            | 0.156" Bullets   |
| L11-WC9N-1  | Chrome Base License Lamp V-Plane Mount w/.156" Barrels              | <input type="checkbox"/> <input type="radio"/>  | 10            | 0.156" Barrels   |
| L12-WB00-1  | Black Base License Lamp Vertical Plane Mount                        | <input type="checkbox"/> <input type="radio"/>  | 10            | Sheathed Pigtail |
| L12-WB5B-1  | Black Base License Lamp Vertical Plane Mount w/.180" Bullets        | <input type="checkbox"/> <input type="radio"/>  | 10            | 0.180" Bullets   |
| L12-WB8B-1  | Black Base License Lamp Vertical Plane Mount 18" Lead W/.180 Bullet | <input type="checkbox"/> <input type="radio"/>  | 10            | 0.180" Bullets   |
| L12-WC00-1  | Chrome Base License Lamp Vertical Plane Mount                       | <input type="checkbox"/> <input type="radio"/>  | 10            | Sheathed Pigtail |
| L14-WB00-1  | Black Base License Lamp Vertical Plane Mount                        | <input type="checkbox"/> <input type="radio"/>  | 10            | Sheathed Pigtail |
| L14-WG00-1  | Grey Base License Lamp Vertical Plane Mount                         | <input type="checkbox"/> <input type="radio"/>  | 10            | Sheathed Pigtail |
| L30-WB00-1  | L34 Large Diameter Grommet  | <input type="checkbox"/> <input type="radio"/>  | 10            | Sheathed Pigtail |
| L31-WB00-1  | License Plate Frame with Light                                      | <input type="checkbox"/> <input type="radio"/>  | 10            | Pigtail (9")     |
| L31-WB0F-1  | License Plate Frame with ATM06-2S Connector                         | <input type="checkbox"/> <input type="radio"/>  | 10            | ATM06-2S         |
| L31-WB10-1  | License Plate Frame with Light, 15" Wire                            | <input type="checkbox"/> <input type="radio"/>  | 10            | Pigtail (15")    |
| L34-0G00-1  | L34 Large Diameter Grommet  | <input type="checkbox"/> <input type="radio"/>  | 10            | Sheathed Pigtail |
| L34-WB9B-1  | License Lamp Black Bracket w/ .180 Bullets                          | <input type="checkbox"/> <input type="radio"/>  | 10            | Sheathed Pigtail |
| L34-WC9B-1  | License Lamp Large Grommet w/ .180 Bullets                          | <input type="checkbox"/> <input type="radio"/>  | 10            | 0.180" Bullets   |
| L34-WG90-1  | License Lamp Standard Grommet 12in Pigtails                         | <input type="checkbox"/> <input type="radio"/>  | 10            | Pigtail (12")    |
| L34-WG9A-1  | License Lamp Standard Grommet w/ Amp Connector                      | <input type="checkbox"/> <input type="radio"/>  | 10            | Amp              |
| L34-WG9B-1  | License Lamp Standard Grommet w/ .180 Bullets                       | <input type="checkbox"/> <input type="radio"/>  | 10            | 0.180" Bullets   |
| L90-0B00-1  | License plate Full Back No Lamp Black                               |   | 10            | -                |
| L90-0B00-K  | License plate frame no light with screw kit                         |   | 10            | -                |
| L90-0G00-1  | License plate frame grey no light                                   |   | 10            | -                |
| L90-0G00-K  | License plate frame grey no light with screw kit                    |   | 10            | -                |
| L95-0B00-1  | License Plate Bracket Black Tecniq                                  |   | 10            | -                |
| L95-1B00-1  | Elevated License Plate Bracket Black                                |   | Made to Order | -                |
| <b>M03 - Customized Projector Light</b>           |   |   |               |                  |
| M03-300A-1  | M03 RGB Projector Lamp Sample                                       |  <input type="radio"/> | Made to Order | -                |
| M03-xxxx-1  | M03 White Projector Lamp  | <input type="checkbox"/> <input type="radio"/>  | Made to Order | Pigtail (9")     |
| <b>M07 - 3 LED RGB Seat Light</b>                 |   |   |               |                  |
| M07-3S00-1  | 3 LED RGB Seat Light SS Cover w Pigtails                            |  <input type="radio"/> |               |                  |
| M07-3S0F-1  | 3 LED RGB Seat Light SS Cover w xT04-4P                             |  <input type="radio"/> |               |                  |
| M07-3S0H-1  | 3 LED RGB Seat Light SS Cover w Bullets/Barrels Harness             |  <input type="radio"/> |               |                  |
| M07-BS00-1  | 3 LED Blue Seat Light SS Cover w Pigtails                           |  <input type="radio"/> |               |                  |
| M07-BS0D-1  | 3 LED Blue Seat Light SS Cover w Weatherpack                        |  <input type="radio"/> |               |                  |
| M07-BSBS-1  | 3 LED Blue Seat Light SS Cover w 180 Bullet/Barrel                  |  <input type="radio"/> |               |                  |
| <b>M10 - Waketower All-Round Navigation Light</b> |   |   |               |                  |
| M10-WA00-1  | M10- All around Lamp Aluminum w Twist Lock                          | <input type="checkbox"/> <input type="radio"/>  | 12            | Pigtail (9")     |



























| Part No.                                   | Part Description   |   | Std Pack | Connector              |
|--|--|---|----------|------------------------|
| M10-WB00-1                                 | M10 All Round Lamp Black Cover   |       | 12       | Pigtail (13")          |
| M10-WB10-1                                 | M10 All Round Lamp Black Cover 16' Wire                                  |       | 12       | Pigtail (16")          |
| <b>M12 - All Around Pole Light</b>         |  |   |          |                        |
| M12-WC120-1                                | M12 All Around Pole Light Chromed Metal Base 12in                        |       | -        | Pigtail (10")          |
| M12-WC140-1                                | M12 All Around Pole Light Chromed Metal Base 14in                        |       | -        | Pigtail (10")          |
| M12-WC180-1                                | M12 All Around Pole Light Chromed Metal Base 18in                        |       | -        | Pigtail (10")          |
| M12-WC240-1                                | M12 All Around Pole Light Chromed Metal Base 24in                        |       | -        | Pigtail (10")          |
| M12-WC300-1                                | M12 All Around Pole Light Chromed Metal Base 30in                        |       | -        | Pigtail (10")          |
| M12-WC360-1                                | M12 All Around Pole Light Chromed Metal Base 36in                        |       | -        | Pigtail (10")          |
| M12-WC420-1                                | M12 All Around Pole Light Chromed Metal Base 42in                        |       | -        | Pigtail (10")          |
| <b>M20 - Navigation Light</b>              |  |   |          |                        |
| M20-2S00-1                                 | Bi color navigation light stainless cover                                |       | 100      | Pigtail (6")           |
| M20-G000-1                                 | Starboard Light Engine with Lens Using Backer                            |       | 100      | Pigtail (6")           |
| M20-GS00-1                                 | Starboard navigation light stainless cover                               |       | 100      | Pigtail (6")           |
| M20-R000-1                                 | Port Light Engine with Lens Using Backer                                 |       | 100      | Pigtail (6")           |
| M20-RS00-1                                 | Port navigation light stainless cover                                    |       | 100      | Pigtail (6")           |
| <b>M21 - Side Mount Navigation Light</b>   |  |   |          |                        |
| M21-GSS0-1                                 | Sidemount Navigation Light w SS Cover Starboard Side                     |       | 10       | Pigtail (9")           |
| M21-GSSD-1                                 | Sidemount Navigation Light w SS Cover Starboard Side w xT06-2S Connector |     | 10       | 9" Deutsch (xT06-2S)   |
| M21-GSSG0-1                                | Sidemount Nav Light w SS Cover Starboard w 4 Degree Angled Gasket        |   | 10       | Pigtail (9")           |
| M21-GSSPF-1                                | Sidemount Navigation Light w SS cover Starboard Side w DT04-3P           |   | 10       | Pigtail (6")           |
| M21-RSP0-1                                 | Sidemount Navigation Light w SS Cover Port Side                          |   | 10       | Pigtail (9")           |
| M21-RSPD-1                                 | Sidemount Navigation Light w SS Cover Port Side w xT06-2S Connector      |   | 10       | 9" Deutsch (xT06-2S)   |
| M21-RSPF-1                                 | Sidemount Navigation Light w SS Cover Port Side w xT04-2P                |   | 10       | xT04-2P                |
| M21-RSPG0-1                                | Sidemount Nav Light w SS Cover Port w 4 Degree Angled Gasket             |   | 10       | Pigtail (9")           |
| M21-RSPPF-1                                | Sidemount Navigation Light w SS cover Port Side w DT04-3P                |   | 10       | Pigtail (6")           |
| <b>M30 - Pontoon Docking Lights</b>        |  |   |          |                        |
| M30-WB030-1                                | White Marine Steady Burn 3 LED Clear Lens                                |   | TBD      | 12" Pigtail            |
| M30-WB060-1                                | White Marine Steady Burn 6 LED Clear Lens                                |   | TBD      | 12" Pigtail            |
| M30-WS030-1                                | White Docking Light 3 LED w SS Trim Ring                                 |   | TBD      | 12" Pigtail            |
| M30-WS03D-1                                | White Docking Light 3 LED w SS Trim Ring W/Deutsch Connector             |   | TBD      | 12" Deutsch Connector  |
| M30-WS060-1                                | White Docking Light 6 LED w SS Trim Ring                                 |   | TBD      | 12" Pigtail            |
| <b>M50 - Water Dragon Underwater Light</b> |  |   |          |                        |
| M50-3S03-1                                 | 3 LED Underwater Light RGB Stainless Cover                               |   | 10       | Sheathed Pigtail (72") |
| M50-3S03R-1                                | Water Dragon Underwater Light Resistive Design, RGB 3 LED                |   | 10       | Sheathed Pigtail (72") |
| M50-3S06-1                                 | 6 LED Underwater Light RGB Stainless Cover                               |   | 10       | Sheathed Pigtail (72") |
| M50-3S06R-1                                | Water Dragon Underwater Light Resistive Design, RGB 6 LED                |   | 10       | Sheathed Pigtail (72") |
| M50-3S12-1                                 | 12 LED Underwater Light RGB Stainless Cover                              |   | 10       | Sheathed Pigtail (72") |
| M50-BS03-1                                 | 3 LED Underwater Light Blue Stainless Cover                              |   | 10       | Sheathed Pigtail (36") |





























| Part No.                               | Part Description  |   | Std Pack | Connector              |
|--|---|---|----------|------------------------|
| M50-BS06-1                             | 6 LED Underwater Light Blue Stainless Cover                               |       | 10       | Sheathed Pigtail (36") |
| M50-BS12-1                             | 12 LED Underwater Light Blue Stainless Cover                              |       | 10       | Sheathed Pigtail (36") |
| M50-BS12D-1                            | 12 LED Underwater Light Blue Stainless Cover w/ Delphi Connector          |       | 10       | Sheathed Pigtail (36") |
| M50-GS03-1                             | 3 LED Underwater Light Green Stainless Cover                              |       | 10       | Sheathed Pigtail (36") |
| M50-GS06-1                             | 6 LED Underwater Light Green Stainless Cover                              |       | 10       | Sheathed Pigtail (36") |
| M50-GS12-1                             | 12 LED Underwater Light Green Stainless Cover                             |       | 10       | Sheathed Pigtail (36") |
| M50-WS03-1                             | 3 LED Underwater Light White Stainless Cover                              |       | 10       | Sheathed Pigtail (36") |
| M50-WS06-1                             | 6 LED Underwater Light White Stainless Cover                              |       | 10       | Sheathed Pigtail (36") |
| M50-WS12-1                             | 12 LED Underwater Light White Stainless Cover                             |       | 10       | Sheathed Pigtail (36") |
| M50-WS12F-1                            | 12 LED Underwater Light White SS Cover w/ DT06-2S Pinned and Kitted       |       | 10       | DT06-2S                |
| M50-WYS12F-1                           | 12 LED Abovewater Light White Stainless Cover w/DT06-2S Pinned and Kitted |       | 10       | DT06-2S                |
| M51-BB03-1                             | Water Dragon Underwater Light, Blue 3 LED                                 |       | 10       | Sheathed Pigtail (36") |
| M51-GB03-1                             | Water Dragon Underwater Light Green, 3 LED                                |       | 10       | Sheathed Pigtail (36") |
| M51-WB03-1                             | Water Dragon Underwater Light,White 3 LED                                 |       | 10       | Sheathed Pigtail (36") |
| M52-4S24F-1                            | RGBW High Output Underwater Light w Dual Deutsch                          |       | TBD      | Dual Deutsch           |
| <b>M51x - Docking/Navigation Light</b> |   |   |          |                        |
| M510-OS03-1                            | M510 Stainless Cover Starboard  |   | TBD      | -                      |
| M510-OS08-1                            | M510 Stainless Cover Port   |   | TBD      | -                      |
| M510-WSP0-1                            | Docking/Navigation Light White LED SS Cover Port Side                     |       | TBD      | Sheathed Pigtail (11") |
| M510-WSPF-1                            | Docking/Nav Light White LED SS Cover Port Side w/ xT06-3S 30" Wire        |   | TBD      | Sheathed (30")         |
| M510-WSS0-1                            | Docking/Navigation Light White LED SS Cover Starboard Side                |   | TBD      | Sheathed Pigtail (11") |
| M511-OS03-1                            | M511 Stainless Cover Starboard  |   | TBD      | Sheathed Pigtail (11") |
| M511-OS08-1                            | M511 Stainless Cover Port   |   | TBD      | Sheathed Pigtail (11") |
| M511-WSP0-1                            | Docking/Navigation Light White Light SS Cover Port Side                   |   | TBD      | Sheathed Pigtail (30") |
| M511-WSPD-1                            | Docking/Nav Light White LED SS Cover Port Side w/ xT04-6P 30" Wire        |   | TBD      | xT04-6P (30")          |
| M511-WSPF-1                            | Docking/Nav Light White LED SS Cover Port Side w/ xT06-3S 30" Wire        |   | TBD      | xT06-6S (30")          |
| M511-WSPPF-1                           | Docking/Navigation Light White Light SS cover Port Side w/ DT04-3P        |   | TBD      | Sheathed Pigtail (30") |
| M511-WSS0-1                            | Docking/Navigation light White Light SS Cover Starboard Side              |   | TBD      | Sheathed Pigtail (30") |
| M511-WSSD-1                            | Docking/Nav Light White LED SS Cover Starboard Side w/ xT04-6P 30" Wire   |   | TBD      | xT04-6P (30")          |
| M511-WSSF-1                            | Docking/Nav Light White LED SS Cover Starboard Side w/ xT06-3S 30" Wire   |   | TBD      | xT06-6S (30")          |
| M511-WSPPF-1                           | Docking/Navigation Light White Light SS cover Starboard Side w/ DT04-3P   |   | TBD      | Sheathed Pigtail (30") |
| M512-WSP0-1                            | Docking/Navigation light White Light SS Cover Port Side                   |   | TBD      | Sheathed Pigtail (30") |
| M512-WSPF-1                            | Sidemount Docking Light White LED SS Cover Port Side w/ xT04-2P           |   | TBD      | xT04-2P (30")          |
| M512-WSS0-1                            | Docking/Navigation light White Light SS Cover Starboard Side              |   | TBD      | Sheathed Pigtail (30") |
| M512-WSSF-1                            | Sidemount Docking Light White LED SS Cover Starboard Side w/ xT04-2P      |   | TBD      | xT04-2P (30")          |
| <b>M57 - Docking/Spreader Light</b>    |   |   |          |                        |
| M57-WB00-1                             | M57 Docking/Spreader Light White light Black Base                         |   | TBD      | 12" Pigtail            |
| M57-WB01-1                             | M57 Docking/Spreader Light White light Black Base/VHB Gasket              |   | TBD      | 12" Pigtail            |
| M57-WW01-1                             | M57 Docking/Spreader Light White light White Base/VHB Gasket              |   | TBD      | 12" Pigtail            |





























































| Part No.                           | Part Description  |   | Std Pack | Connector             |
|------------------------------------|---|---|----------|-----------------------|
| <b>M90 - Interior Accent Light</b> |   |   |          |                       |
| M90-3C00-1                         | Interior Accent Light, RGB LED                              |  ○   | 50       | Sheathed Pigtail (9") |
| M90-3S00-1                         | Interior Accent Light,Red Green Blue, TPU Gasket, Nylon Nut |  ○   | 50       | Sheathed Pigtail (9") |
| M90-BC00-1                         | Live Well Light, Blue, TPU Gasket, Nylon Nut                |  ○   | 50       | Sheathed Pigtail (9") |
| M90-BC0F-1                         | Live Well Light, Blue, TPU Gasket, Nylon Nut w xTM06-2S     |  ○   | 50       | Sheathed Pigtail (9") |
| M90-BS00-1                         | Interior Accent Light, Blue LED, SS Cover                   |  ○   | 50       | Sheathed Pigtail (9") |
| M90-GC00-1                         | Live Well Light, Green, TPU Gasket, Nylon Nut               |  ○   | 50       | Sheathed Pigtail (9") |
| M90-GS00-1                         | Interior Accent Light, Green LED, SS Cover                  |  ○   | 50       | Sheathed Pigtail (9") |
| M90-RC00-1                         | Live Well Light, Red, TPU Gasket, Nylon Nut                 |  ○   | 50       | Sheathed Pigtail (9") |
| M90-RS00-1                         | Interior Accent Light, Red LED, SS Cover                    |  ○   | 50       | Sheathed Pigtail (9") |
| M90-WC00-1                         | Live Well Light, White, TPU Gasket, Nylon Nut               |  ○   | 50       | Sheathed Pigtail (9") |
| M90-WS00-1                         | Interior Accent Light, White LED, SS Cover                  |  ○   | 50       | Sheathed Pigtail (9") |
| M91-4F00-1                         | 1" Round RGBW LED Diffused Accent Light                     |  ○   | -        | Pigtail (9")          |
| <b>P0x - SteelHead Work Lights</b> |   |   |          |                       |
| P02-HWKIT-1                        | P02/P04 Mounting Hardware Kit                               |   | 4        | Sheathed Pigtail      |
| P02-WBFP-1                         | SteelHead Flood Lamp 2 LED Black Finish Pigtail Wires       |  ○   | 4        | Sheathed Pigtail      |
| P02-WBSP-1                         | SteelHead Spot Lamp 2 LED Black Finish Pigtail Wires        |  ○   | 4        | Sheathed Pigtail      |
| P02-WWFP-1                         | SteelHead Flood Lamp 2 LED White Finish Pigtail Wires       |  ○   | 4        | Sheathed Pigtail      |
| P02-WWSP-1                         | SteelHead Spot Lamp 2 LED White Finish Pigtail Wires        |  ○   | 4        | Sheathed Pigtail      |
| P04-ABFP-1                         | Amber SteelHead Flood Lamp 4 LED Black Finish Pigtail Wire  |  ○ | 2        | Sheathed Pigtail      |
| P04-ABSP-1                         | Amber SteelHead Spot Lamp 4 LED Black Finish Pigtail Wires  |  ○ | 2        | Sheathed Pigtail      |
| P04-BBFP-1                         | Blue SteelHead Flood Lamp 4 LED Black Finish Pigtail Wire   |  ○ | 2        | Sheathed Pigtail      |
| P04-BBSP-1                         | Blue SteelHead Spot Lamp 4 LED Black Finish Pigtail Wires   |  ○ | 2        | Sheathed Pigtail      |
| P04-GBFP-1                         | Green SteelHead Flood Lamp 4 LED Black Finish Pigtail Wire  |  ○ | 2        | Sheathed Pigtail      |
| P04-GBSP-1                         | Green SteelHead Spot Lamp 4 LED Black Finish Pigtail Wires  |  ○ | 2        | Sheathed Pigtail      |
| P04-RBFP-1                         | Red SteelHead Flood Lamp 4 LED Black Finish Pigtail Wire    |  ○ | 2        | Sheathed Pigtail      |
| P04-RBSP-1                         | Red SteelHead Spot Lamp 4 LED Black Finish Pigtail Wires    |  ○ | 2        | Sheathed Pigtail      |
| P04-WBFA-1                         | White SteelHead Flood Lamp 4 LED Black Finish w 2 pin Amp   |  ○ | 2        | Sheathed Pigtail      |
| P04-WBFP-1                         | White SteelHead Flood Lamp 4 LED Black Finish Pigtail Wire  |  ○ | 2        | Sheathed Pigtail      |
| P04-WBSP-1                         | White SteelHead Spot Lamp 4 LED Black Finish Pigtail Wires  |  ○ | 2        | Sheathed Pigtail      |
| P04-WWFP-1                         | SteelHead Flood Lamp 4 LED White Finish Pigtail Wires       |  ○ | 2        | Sheathed Pigtail      |
| P04-WWSP-1                         | SteelHead Spot Lamp 4 LED White Finish Pigtail Wires        |  ○ | 2        | Sheathed Pigtail      |
| P06-ABFP-1                         | Amber SteelHead Flood Lamp 6 LED Black Finish Pigtail Wires |  ○ | 2        | Sheathed Pigtail      |
| P06-ABSP-1                         | Amber SteelHead Spot Lamp 6 LED Black Finish Pigtail Wires  |  ○ | 2        | Sheathed Pigtail      |
| P06-BBFP-1                         | Blue SteelHead Flood Lamp 6 LED Black Finish Pigtail Wires  |  ○ | 2        | Sheathed Pigtail      |
| P06-BBSP-1                         | Blue SteelHead Spot Lamp 6 LED Black Finish Pigtail Wires   |  ○ | 2        | Sheathed Pigtail      |
| P06-GBFP-1                         | Green SteelHead Flood Lamp 6 LED Black Finish Pigtail Wires |  ○ | 2        | Sheathed Pigtail      |
| P06-GBSP-1                         | Green SteelHead Spot Lamp 6 LED Black Finish Pigtail Wires  |  ○ | 2        | Sheathed Pigtail      |
| P06-HWKIT-1                        | P06 Mounting Hardware Kit                                   |   | 2        | Sheathed Pigtail      |













































































| Part No.                                    | Part Description  |   | Std Pack | Connector               |
|---|---|---|----------|-------------------------|
| P06-RBFP-1                                  | Red SteelHead Flood Lamp 6 LED Black Finish Pigtail Wires                       |       | 2        | Sheathed Pigtail        |
| P06-RBSP-1                                  | Red SteelHead Spot Lamp 6 LED Black Finish Pigtail Wires                        |       | 2        | Sheathed Pigtail        |
| P06-WBFP-1                                  | White SteelHead Flood Lamp 6 LED Black Finish Pigtail Wires                     |       | 2        | Sheathed Pigtail        |
| P06-WBSP-1                                  | White SteelHead Spot Lamp 6 LED Black Finish Pigtail Wires                      |       | 2        | Sheathed Pigtail        |
| P06-WWFP-1                                  | SteelHead Flood Lamp 6 LED White Finish Pigtail Wires                           |       | 2        | Sheathed Pigtail        |
| P06-WWSP-1                                  | SteelHead Spot Lamp 6 LED White Finish Pigtail Wires                            |       | 2        | Sheathed Pigtail        |
| <b>P10 - Flush Mount Spreader Light</b>     |   |   |          |                         |
| P10-WBFP-1                                  | Spreader Light, White LED, Flush Mt. Black Finish, Pigtail Wires                |       | 2        | Sheathed Pigtail (9")   |
| P10-WRBFP-1                                 | Spreader Light, White & Red LED, Flush Mt. Black Finish, Pigtail Wires          |       | 2        | Sheathed Pigtail (9")   |
| P10-WRFP-1                                  | Spreader Light, White & Red LED, Flush Mt. White Finish, Pigtail Wires          |       | 2        | Sheathed Pigtail (9")   |
| P10-WWFP-1                                  | Spreader Light, White LED, Flush Mt. White Finish, Pigtail Wires                |       | 2        | Sheathed Pigtail (9")   |
| <b>P11 - Surface Mount Spreader Light</b>   |   |   |          |                         |
| P11-HWKIT-1                                 | P11 Mounting Hardware Kit   |   | 2        | Sheathed Pigtail (9")   |
| P11-WBFP-1                                  | Spreader Light, White LED Surface Mt. Black Finish Pigtail Wires                |       | 2        | Sheathed Pigtail (9")   |
| P11-WRBFP-1                                 | Spreader Light, White & Red LED, Surface Mt. Black Finish, Pigtail Wires        |       | 2        | Sheathed Pigtail (9")   |
| P11-WRFP-1                                  | Spreader Light, White & Red LED, Surface Mt. White Finish, Pigtail Wires        |       | 2        | Sheathed Pigtail (9")   |
| P11-WWFP-1                                  | Spreader Light, White LED Surface Mt. White Finish Pigtail Wires                |       | 2        | Sheathed Pigtail (9")   |
| <b>Rxx - Conspicuity Reflectors</b>         |   |   |          |                         |
| R03-0A00-1                                  | Amber 3" Round Reflector Orafol - V32-1749-030026                               |   | 1        | -                       |
| R03-0R00-1                                  | Red 3" Round Reflector Orafol - V32-1249-030026                                 |   | 1        | -                       |
| R05-0A00-1                                  | Amber 2" x 3.5" Rectangular SAE Reflector Orafol - V32-1749-020168              |   | 1        | -                       |
| R05-0R00-1                                  | Red 2" x 3.5" Rectangular SAE Reflector Orafol - V32-1249-020168                |   | 1        | -                       |
| R10-0RW0-1                                  | Red 11" x White 7" OEM Grade DOT - V82-5549-020150                              |   | 1        | -                       |
| R10-0W00-1                                  | White 2" x 150' OEM Grade DOT   |   | 1        | -                       |
| <b>S12 - 2.5" Round P2 Rated Sidemarker</b> |   |   |          |                         |
| S10-0G00-1                                  | 2.5" Round Sidemarker Grommet   |   | 150      | -                       |
| S12-AA00-1                                  | 2 1/2 Inch Round Marker Amber   |   | 150      | Fem 2 Pole (S99-0010-1) |
| S12-AA40-1                                  | 2 1/2 Inch Round 4 LED Marker Amber   |   | 150      | Fem 2 Pole (S99-0010-1) |
| S12-RR00-1                                  | 2 1/2 Inch Round Marker Red   |   | 150      | Fem 2 Pole (S99-0010-1) |
| S12-RR40-1                                  | 2 1/2 Inch Round 4 LED Marker Red   |   | 150      | Fem 2 Pole (S99-0010-1) |
| <b>S14 - PC/P2 Rated Sidemarker</b>         |   |   |          |                         |
| S14-AAP0-1                                  | S14 Amber PCP2 Stud Mount Stainless Steel Marker Light Amber Lens Pigtail       |   | 100      | Pigtail                 |
| S14-AAP1-1                                  | S14 Amber PCP2 Stud Mount Stainless Steel Marker Light Amber Lens W/24" Pigtail |   | 100      | Pigtail                 |
| S14-AAS0-1                                  | S14 Amber PCP2 Stud Mount Marker Light Amber Lens Pigtail                       |   | 100      | Pigtail                 |
| S14-AAS1-1                                  | S14 Amber PCP2 Stud Mount Marker Amber Lens, 24" Wire                           |   | 100      | Pigtail                 |
| S14-ACS0-1                                  | S14 Amber PCP2 Stud Mount Marker Light Clear Lens Pigtail                       |   | 100      | Pigtail                 |
| S14-RCS0-1                                  | S14 Red PCP2 Stud Mount Marker Light Clear Lens Pigtail                         |   | 100      | Pigtail                 |
| S14-RRP0-1                                  | S14 Red PCP2 Stud Mount Stainless Steel Marker Light Red Lens Pigtail           |   | 100      | Pigtail                 |
| S14-RRP1-1                                  | S14 Red PCP2 Stud Mount Stainless Steel Marker Light Red Lens W/24" Pigtail     |   | 100      | Pigtail                 |















































































| Part No.                            | Part Description  |   | Std Pack | Connector               |
|-------------------------------------|---|---|----------|-------------------------|
| S14-RRS0-1                          | S14 Red PCP2 Stud Mount Marker Light Red Lens Pigtail             |    | 100      | Pigtail                 |
| S14-RRS1-1                          | S14 Red PCP2 Stud Mount Marker Red Lens, 24" Wire                 |    | 100      | Pigtail                 |
| <b>S15 - PC Rated Sidemarker</b>    |   |   |          |                         |
| S15-0B00-1                          | Model S150 Base Black   |   | 100      | -                       |
| S15-0G00-1                          | Model S150 Grommet Black  |   | 100      | -                       |
| S15-0S00-1                          | Model S150 Base Chrome  |   | 100      | -                       |
| S15-AA00-1                          | Model S150 Amber PC Sidemarker Amber Lens                         |    | 120      | Fem 2 Pole              |
| S15-AA0P-1                          | Model S150 Amber PC Sidemarker Amber Lens 14" Pigtail             |    | 200      | Pigtail                 |
| S15-AC00-1                          | Model S150 Amber PC Sidemarker Clear Lens                         |    | 120      | Fem 2 Pole              |
| S15-AC0P-1                          | Model S150 Amber PC Sidemarker Clear Lens 14" Pigtail             |    | 200      | Pigtail                 |
| S15-RC00-1                          | Model S150 Red PC Sidemarker Clear Lens                           |    | 120      | Fem 2 Pole              |
| S15-RC0P-1                          | Model S150 Red PC Sidemarker Clear Lens 14" Pigtail               |    | 200      | Pigtail                 |
| S15-RR00-1                          | Model S150 Red PC Sidemarker Red Lens                             |    | 120      | Fem 2 Pole              |
| S15-RR0P-1                          | Model S150 Red PC Sidemarker Red Lens 14" Pigtail                 |    | 200      | Pigtail                 |
| <b>S17 - PC/P2 Rated Sidemarker</b> |   |   |          |                         |
| S17-0AS0-1                          | S17 Sidemarker Aluminum Mounting Bracket                          |   | 100      | -                       |
| S17-0B00-1                          | S17 Black Back  |   | 100      | -                       |
| S17-0C00-1                          | S17 Chrome Back   |   | 100      | -                       |
| S17-0G00-1                          | S17 Small Gasket  |   | 100      | -                       |
| S17-0G20-1                          | S17 Large Gasket  |   | 100      | -                       |
| S17-0GB0-1                          | S17 Large Gasket with Black Back Kit                              |   | 100      | -                       |
| S17-0GC0-1                          | S17 Large Gasket with Chrome Back Kit                             |   | 100      | -                       |
| S17-0SS0-1                          | S17-Sidemarker SS Mounting Bracket                                |   | 100      | -                       |
| S17-AA0P-1                          | S17 Amber PCP2 Marker Light Amber Lens Pigtail                    |  | 100      | Pigtail                 |
| S17-AA20-1                          | S17 Amber PCP2 Marker Dual Intensity Light Amber Lens Pigtail     |  | 100      | Pigtail                 |
| S17-AA2G0-1                         | Amber PCP2 Marker Dual intensity with gasket 12" wire             |  | 100      | Pigtail                 |
| S17-AAG0-1                          | S17 Amber PCP2 Marker Light Amber Lens Self Ground Pigtail        |  | 100      | Pigtail / Self grounded |
| S17-AAGB-1                          | S17 Amber PCP2 Marker Light Amber Lens .180 Bullet w/#10 GND Ring |  | 100      | 0.180" Bul / GND Ring   |
| S17-AC0M-1                          | S17 Amber P2PC SM Light Clear Lens w/.156" Bullets                |  | 100      | Pigtail / 0.156" Bullet |
| S17-AC0P-1                          | S17 Amber PCP2 Marker Light Clear Lens Pigtail                    |  | 100      | Pigtail                 |
| S17-ACG0-1                          | S17 Amber PCP2 Marker Light Clear Lens Self Ground Pigtail        |  | 100      | Pigtail / Self grounded |
| S17-AT0P-1                          | S17 Amber PCP2 Marker Light Tinted Lens Pigtail                   |  | 100      | Pigtail                 |
| S17-ATG0-1                          | S17 Amber PCP2 Marker Light Tinted Lens Self Ground Pigtail       |  | 100      | Pigtail                 |
| S17-RC0M-1                          | S17 Red P2PC SM Light Clear Lens w/.156" Bullets                  |  | 100      | 0.156" Bullets          |
| S17-RC0P-1                          | S17 Red PCP2 Marker Light Clear Lens Pigtail                      |  | 100      | Pigtail                 |
| S17-RCG0-1                          | S17 Red PCP2 Marker Light Clear Lens Self Ground Pigtail          |  | 100      | Pigtail / Self grounded |
| S17-RR0P-1                          | S17 Red PCP2 Marker Light Red Lens Pigtail                        |  | 100      | Pigtail                 |
| S17-RR2G0-1                         | Red PCP2 Marker Dual intensity with gasket                        |  | 100      | Pigtail                 |
| S17-RRG0-1                          | S17 Red PCP2 Marker Light Red Lens Self Ground Pigtail            |  | 100      | Pigtail / Self grounded |











































































| Part No.                            | Part Description   |   | Std Pack | Connector               |
|-------------------------------------|--|---|----------|-------------------------|
| S17-RRGB-1                          | S17 Red PCP2 Marker Light Red Lens .180 Bullet w/#10 GND Ring    |    | 100      | 0.180" Bul / GND Ring   |
| S17-RT0P-1                          | S17 Red PCP2 Marker Light Tinted Lens Pigtail                    |    | 100      | Pigtail                 |
| S17-RTG0-1                          | S17 Red PCP2 Marker Light Tinted Lens Self Ground Pigtail        |    | 100      | Pigtail / Self grounded |
| <b>S18 - PC/P2 Rated Sidemarker</b> |  |   |          |                         |
| S18-0G00-1                          | S18 Neoprene Gasket  |   | 100      | -                       |
| S18-AA00-1                          | S18 Sidemarker Amber Lens Amber LED                              |    | 100      | Pigtail                 |
| S18-AAG0-1                          | S18 Sidemarker Amber Lens Amber LED Self Grounding               |    | 100      | Pigtail / Self grounded |
| S18-AC00-1                          | S18 Sidemarker Clear Lens Amber LED                              |    | 100      | Pigtail                 |
| S18-ACG0-1                          | S18 Sidemarker Clear Lens Amber LED Self Grounding               |    | 100      | Pigtail / Self grounded |
| S18-RC00-1                          | S18 Sidemarker Clear Lens Red LED                                |    | 100      | Pigtail                 |
| S18-RCG0-1                          | S18 Sidemarker Clear Lens Red LED Self Grounding                 |    | 100      | Pigtail / Self grounded |
| S18-RR00-1                          | S18 Sidemarker Red Lens Red LED                                  |    | 100      | Pigtail                 |
| S18-RRG0-1                          | S18 Sidemarker Red Lens Red LED Self Grounding                   |    | 100      | Pigtail / Self grounded |
| S18-WC00-1                          | S18 Area Lamp Clear Lens White LED                               |    | 100      | Pigtail                 |
| S18-WC0D-1                          | S18 Area Lamp Clear Lens White LED W/Delphi                      |    | 100      | Delphi                  |
| <b>S19 - PC Rated Sidemarker</b>    |  |   |          |                         |
| S19-0B00-1                          | Black 1" x4" Self Grounding Base                                 |   | 120      | -                       |
| S19-0C00-1                          | Chrome 1" x4" Self Grounding Base                                |   | 120      | -                       |
| S19-AA00-1                          | 1"x4" Amber PC Sidemarker Amber Lens                             |    | 120      | Self-grounding base     |
| S19-AC00-1                          | 1"x4" Amber PC Sidemarker Clear Lens                             |  | 120      | Self-grounding base     |
| S19-RC00-1                          | 1"x4" Red PC Sidemarker Clear Lens                               |  | 120      | Self-grounding base     |
| S19-RR00-1                          | 1"x4" Red PC Sidemarker Red Lens                                 |  | 120      | Self-grounding base     |
| <b>S21 - P2 Rated Sidemarker</b>    |  |   |          |                         |
| S21-0G00-1                          | Sidemarker Gasket  |   | 100      | -                       |
| S21-0G20-1                          | Sidemarker Molded Rubber Gasket                                  |   | 100      | -                       |
| S21-0S00-1                          | 2" Oval Sidemarker SS Trim Ring                                  |   | 100      | -                       |
| S21-AA00-1                          | 2" Oval Amber Sidemarker Amber Lens                              |  | 100      | Sheathed Pigtail        |
| S21-AAG0-1                          | 2" Oval Amber Sidemarker Amber Lens Self Grounding               |  | 100      | Pigtail / Self grounded |
| S21-AAGB-1                          | 2" Oval Amber Sidemarker Amber Lens Self Grounding w/.180 bullet |  | 100      | Pigtail / 0.180" Bul    |
| S21-AAGBS-1                         | 2" Oval Amber Sidemarker Amber Lens Self Grounding               |  | 100      | Pigtail / Self grounded |
| S21-AC00-1                          | 2" Oval Amber Sidemarker Clear Lens                              |  | 100      | Sheathed Pigtail        |
| S21-ACG0-1                          | 2" Oval Amber Sidemarker Clear Lens Self Grounding               |  | 100      | Pigtail / Self grounded |
| S21-RC00-1                          | 2" Oval Red Sidemarker Clear Lens                                |  | 100      | Sheathed Pigtail        |
| S21-RCG0-1                          | 2" Oval Red Sidemarker Clear Lens Self Grounding                 |  | 100      | Pigtail / Self grounded |
| S21-RR00-1                          | 2" Oval Red Sidemarker Red Lens                                  |  | 100      | Sheathed Pigtail        |
| S21-RRG0-1                          | 2" Oval Red Sidemarker Red Lens Self Grounding                   |  | 100      | Pigtail / Self grounded |
| S21-RRGB-1                          | 2" Oval Red Sidemarker Red Lens Self Grounding / .180 bullet     |  | 100      | Pigtail / 0.180" Bul    |
| S21-RRGBS-1                         | 2" Oval Red Sidemarker Red Lens Self Grounding w/                |  | 100      | Pigtail / Self grounded |
| <b>S22 - 2"x 6" PC Sidemarker</b>   |  |   |          |                         |



| Part No.  | Part Description  |   | Std Pack | Connector                |
|---|---|---|----------|--------------------------|
| S22-AA00-1  | Amber 2" x 6" PC Sidemarker with reflector                        |       | 100      | Two Pole (S99-3600-1)    |
| S22-AADT-1  | Amber 2" x 6" Dual Intensity PC Sidemarker with reflector         |       | 100      | Pigtail                  |
| S22-RR00-1  | Red 2" x 6" PC Sidemarker with reflector                          |       | 100      | Two Pole (S99-3600-1)    |
| <b>S24 - 2.5" PC sidemarker w/reflector</b>       |   |   |          |                          |
| S24-AA00-1  | 2.5" Round Amber PC Sidemarker w/Reflector                        |       | 125      | Fem 2 Pole (S99-0010-1)  |
| S24-RR00-1  | 2.5" Round Red PC Sidemarker w/Reflector                          |       | 125      | Fem 2 Pole (S99-0010-1)  |
| <b>S25 - Surface Mount Sidemarker w/reflector</b> |   |   |          |                          |
| S25-AA00-1  | 2" x 3" Amber SM w Reflector                                      |       | TBD      | Unsheathed Pigtail (11") |
| S25-AA0MN-1                                       | 2" x 3" Amber SM w Reflector w 156 bullet and barr                |       | TBD      | 0.156" Bul / Barrel      |
| S25-AAGBS-1                                       | 2" x 3" Amber SM w Reflector w/ gnd ring and 180 bullet/barrel    |       | TBD      | 0.180" Bul / GND Ring    |
| S25-RR00-1  | 2" x 3" Red SM w Reflector  |       | TBD      | Unsheathed Pigtail (11") |
| S25-RR0MN-1                                       | 2" x 3" Red SM w Reflector w 156 bullet and barrel                |       | TBD      | 0.156" Bul / Barrel      |
| S25-RRGBS-1                                       | 2" x 3" Red SM w Reflector w/ gnd ring and 180 bullet/barrel      |       | TBD      | 0.180" Bul / GND Ring    |
| <b>S27 - 3" Round SM Reflector</b>                |   |   |          |                          |
| S27-AA0A-1  | 3" Round Amber SM Reflector W 2P Amp                              |       | TBD      | 0                        |
| S27-RR0A-1  | 3" Round Red SM Reflector W 2P Amp                                |       | TBD      | 0                        |
| <b>S30 - 2" round P2 Rated Sidemarker</b>         |   |   |          |                          |
| S30-0G00-1  | 2" Round Sidemarker Grommet                                       |   | 125      | -                        |
| S30-AA00-1  | 2" Round Amber Sidemarker Amber Lens                              |       | 125      | Fem 2 Pole (S99-0010-1)  |
| S30-AA0F-1  | 2" Round Amber Sidemarker Amber Lens w xT06-2S Connector          |   | 125      | xT06-6S                  |
| S30-AA0P-1  | 2" Round Amber Sidemarker Amber Lens w/ Pig Tail                  |   | 125      | Pigtail                  |
| S30-AC00-1  | 2" Round Amber Sidemarker Clear Lens                              |   | 125      | Fem 2 Pole (S99-0010-1)  |
| S30-AC0F-1  | 2" Round Amber Sidemarker Clear Lens w xT06-2S Connector          |   | 125      | xT06-6S                  |
| S30-AC0P-1  | 2" Round Amber Sidemarker Clear Lens w/ Pig Tail                  |   | 125      | Pigtail                  |
| S30-RC00-1  | 2" Round Red Sidemarker Clear Lens                                |   | 125      | Fem 2 Pole (S99-0010-1)  |
| S30-RC0F-1  | 2" Round Red Sidemarker Red Lens w xT06-2S Connector              |   | 125      | xT06-6S                  |
| S30-RC0P-1  | 2" Round Red Sidemarker Clear Lens w/ Pig Tail                    |   | 125      | Pigtail                  |
| S30-RR00-1  | 2" Round Red Sidemarker Red Lens                                  |   | 125      | Fem 2 Pole (S99-0010-1)  |
| S30-RR0P-1  | 2" Round Red Sidemarker Red Lens w/ Pig Tail                      |   | 125      | Pigtail                  |
| S30-WC00-1  | 2" Round White Area Light Clear Lens                              |   | 125      | Fem 2 Pole (S99-0010-1)  |
| <b>S33 - P2 Rated Sidemarker</b>                  |   |   |          |                          |
| S33-0G00-1  | S33 Grommet Black   |   | 100      | -                        |
| S33-0G10-1  | S33 Gasket w/O-Ring Thick Material                                |   | 100      | -                        |
| S33-0G1A-1  | Gasket w/O-Ring Thick Material High Durometer                     |   | 100      | -                        |
| S33-0S00-1  | S33/S34 Stainless Steel Trim Ring                                 |   | 100      | -                        |
| S33-AA00-1  | 3/4" Mini P2 Amber Sidemarker Amber Lens 12" Wire                 |   | 100      | Sheathed Pigtail         |
| S33-AA09-1  | 3/4" Mini P2 Amber Sidemarker Amber Lens, Black Positive 12" Wire |   | 100      | Sheathed Pigtail         |
| S33-AA9B-1  | 3/4" Mini P2 Amber Sidemarker Amber Lens w/.180 Bullet & 12" Wire |   | 100      | 0.180" Bullets           |
| S33-AA9H-1  | Amber Mini P2 Sidemarker Amber Lens Black Positive 18" Wire       |   | 100      | Sheathed Pigtail (18")   |

























| Part No.                         | Part Description   |   | Std Pack | Connector              |
|----------------------------------|--|---|----------|------------------------|
| S33-AAFB-1                       | 3/4" Mini P2 Amber Sidemarker Amber Lens w/.180 Bullets & 18" Wire                   |       | 100      | 0.180" Bullets (18")   |
| S33-AC00-1                       | 3/4" Mini P2 Amber Sidemarker Clear Lens 12" Wire                                    |       | 100      | Sheathed Pigtail       |
| S33-AC09-1                       | 3/4" Mini P2 Amber Sidemarker Clear Lens Black Positive, 12" Wire                    |       | 100      | Sheathed Pigtail       |
| S33-AC9B-1                       | 3/4" Mini P2 Amber Sidemarker Clear Lens w/.180 Bullet & 12" Wire                    |       | 100      | 0.180" Bullets         |
| S33-AC9H-1                       | Amber Mini P2 Sidemarker Amber Lens Black Positive, 18" Wire                         |       | 100      | Sheathed Pigtail (18") |
| S33-ACFB-1                       | 3/4" Mini P2 Amber Sidemarker Clear Lens W/.180 Bullets & 18" Wire                   |       | 100      | 0.180" Bullets (18")   |
| S33-BC00-1                       | 3/4" Round Low Profile Blue Indicator 12" Wire                                       |       | 100      | Sheathed Pigtail       |
| S33-GC00-1                       | 3/4" Round Low Profile Green Indicator 12" Wire                                      |       | 100      | Sheathed Pigtail       |
| S33-RC00-1                       | 3/4" Mini P2 Red Sidemarker Clear Lens 12" Wire                                      |       | 100      | Sheathed Pigtail       |
| S33-RC09-1                       | 3/4" Mini P2 Red Sidemarker Clear Lens Black Positive 12" Wire                       |       | 100      | Sheathed Pigtail       |
| S33-RC9B-1                       | 3/4" Mini P2 Red Sidemarker Clear Lens W/.180 Bullets & 12" Wire                     |       | 100      | 0.180" Bullets         |
| S33-RC9H-1                       | Red P2 Sidemarker Clear Lens Black Positive 18" Wire                                 |       | 100      | Sheathed Pigtail (18") |
| S33-RCFB-1                       | 3/4" Mini P2 Red Sidemarker Clear Lens W/.180 Bullets & 18" Wire                     |       | 100      | 0.180" Bullets (18")   |
| S33-RR00-1                       | 3/4" Mini P2 Red Sidemarker Red Lens 12" Wire  |       | 100      | Sheathed Pigtail       |
| S33-RR09-1                       | 3/4" Mini P2 Red Sidemarker Red Lens Black Positive 12" Wire                         |       | 100      | Sheathed Pigtail       |
| S33-RR9B-1                       | 3/4" Mini P2 Red Sidemarker Red Lens W/.180 Bullet & 12" Wire                        |       | 100      | 0.180" Bullets         |
| S33-RR9H-1                       | Red P2 Sidemarker Red Lens Black Positive 18" Wire                                   |       | 100      | Sheathed Pigtail (18") |
| S33-RRFB-1                       | 3/4" Mini P2 Red Sidemarker Red Lens W/.180 Bullets & 18" Wire                       |       | 100      | 0.180" Bullets (18")   |
| S33-WC00-1                       | 3/4" Round Low Profile White Indicator 12" Wire                                      |       | 100      | Sheathed Pigtail       |
| S33-WC0B-1                       | 3/4" Round Low Profile White Indicator W/.180 Bullets & 12" Wire                     |   | 100      | 0.180" Bullets         |
| S33-WC0V-1                       | 3/4" Round Low Profile White Indicator with Butt connector 12" Wire                  |   | 100      | Butt Connector (12")   |
| <b>S34 - PC Rated Sidemarker</b> |  |   |          |                        |
| S34-3C00-1                       | S34 RGB Light W/Pigtails 7.5" Wire   |   | 100      | Sheathed Pigtail       |
| S34-3CHF-1                       | S34 RGB Light w Harness and xT04-4P  |   | 100      | Sheathed Pigtail       |
| S34-AA00-1                       | Amber Mini PC Sidemarker Amber Lens 8.5" Wire  |   | 100      | Sheathed Pigtail       |
| S34-AA09-1                       | Amber Mini PC Sidemarker Amber Lens Black Positive 8.5" Wire                         |   | 100      | Sheathed Pigtail       |
| S34-AA0B-1                       | Amber Mini PC Sidemarker Amber Lens w/.180 Bullet 12" Wire                           |   | 100      | 0.180" Bullets (12")   |
| S34-AA0F-1                       | Amber Mini PC Sidemarker Amber Lens xTMO6-2S   |   | 100      | xTMO6-2S               |
| S34-AA14C-1                      | Amber PC sidemarker Amber Lens with 14inc 2C Wire and 2P C Connector                 |   | 100      | 2P C Connector         |
| S34-AA17B-1                      | S34 Amber Mini PC Sidemarker Amber Lens with 11" Wire and Grommet and 0.180" Barrels |   | 100      | 0.180" Bullets (11")   |
| S34-AA20-1                       | Amber Mini PC Sidemarker Amber Lens dual intensity pigtail 6" Wire                   |   | 100      | Sheathed Pigtail       |
| S34-AA30C-1                      | Amber PC Sidemarker Amber Lens w/2 Pole Connector Thin Grommet                       |   | 100      | 2 Pole                 |
| S34-AA23-1                       | Amber Mini PC Sidemarker Amber Lens Dual intensity Pigtail 12" Wire                  |   | 100      | Sheathed Pigtail       |
| S34-AA2B-1                       | Dual Intensity Amber Mini PC Sidemarker Amber Lens w/.180 Bullet 6" Wire             |   | 100      | 0.180" Bullets (6")    |
| S34-AA39P-1                      | Amber Mini PC Sidemarker Amber Lens Thin Grommet w                                   |   | 100      | 0                      |
| S34-AA49B-1                      | Amber Mini PC Sidemarker Amber Lens w/.180 Bullet 40" wire                           |   | 100      | Sheathed Pigtail       |
| S34-AA9A-1                       | Amber Mini PC Sidemarker Amber Lens w/.156 Bullet                                    |   | 100      | 0.156" Bullets         |
| S34-AA9B-1                       | Amber Mini PC Sidemarker Amber Lens w/.180 Bullet 12" reverse wire                   |   | 100      | 0.180" Bullets         |
| S34-AA9F-1                       | Amber Mini PC Sidemarker Amber Lens 2P Deutsch Connector 8.5" wire                   |   | 100      | Deutsch Conn (8.5")    |



































| Part No.    | Part Description  |   | Std Pack | Connector                  |
|-------------|---|---|----------|----------------------------|
| S34-AA9G-1  | Amber Mini PC Sidemarker Amber Lens 11 inch wire with Ground Ring               |       | 100      | Pigtail (11")/<br>Gnd Ring |
| S34-AA9H-1  | Amber Mini PC Sidemarker Amber Lens 18" Wire Black Positive                     |       | 100      | Sheathed Pigtail<br>(18")  |
| S34-AA9HM-1 | Amber Mini PC Sidemarker Amber Lens 18" Wire Lead W/.156 Bullets Black Positive |       | 100      | 0.156" Bullets<br>(18")    |
| S34-AA9L-1  | Amber Mini PC Sidemarker Amber Lens 11 inch wire                                |       | 100      | Sheathed Pigtail<br>(11")  |
| S34-AA9M-1  | Amber Mini PC SM Amber Lens Black Positive Wire w/.156" Bullets 8.5" Wire       |       | 100      | 0.156" Bullets             |
| S34-AA9N-1  | Amber Mini PC Amber Lens Black Positive Wire w .156" Barrels 8.5" Wire          |       | 100      | 0.156" Barrels             |
| S34-AA9U-1  | Amber Mini PC SideMarker Amber Lens .156 Barrel w/ Shroud                       |       | 100      | 0.156" Bullets             |
| S34-AAE05-1 | Amber Mini PC SM Amber Lens 5' Wire   |       | 100      | 0.180" Bullets             |
| S34-AAE20-1 | Amber Mini PC SM Amber Lens 20' Wire  |       | 100      | 0.180" Bullets             |
| S34-AAE40-1 | Amber Mini PC SM Amber Lens 40' Wire  |       | 100      | 0.180" Bullets             |
| S34-AAN9-1  | Amber Mini PC Sidemarker Amber Lens W/ NO sheath NO TIN w/8.5" wire             |       | 100      | Pigtail (9")               |
| S34-AC00-1  | Amber Mini PC Sidemarker Clear Lens with 12' Wire                               |       | 100      | Sheathed Pigtail           |
| S34-AC09-1  | Amber Mini PC Sidemarker Clear Lens Black Positive 12" wire                     |       | 100      | Sheathed Pigtail           |
| S34-AC9B-1  | Amber Mini PC Sidemarker Clear Lens w/.180 Bullet 12" wire                      |       | 100      | 0.180" Bullets             |
| S34-AC9H-1  | Amber Mini PC Sidemarker Clear Lens 18` Black Positive wire                     |       | 100      | Sheathed Pigtail<br>(18")  |
| S34-AT09-1  | Amber Mini PC Sidemarker Tinted Lens w Pigtail Wire                             |       | 100      | 0                          |
| S34-BC00-1  | Blue Accent Light Clear Lens w/8.5" wire  |       | 100      | Sheathed Pigtail           |
| S34-BC0M-1  | Blue Mini PC Sidemarker Clear Lens w/.156" Bullets                              |       | 100      | 0.156" Bullets             |
| S34-GC0M-1  | Green Mini PC Sidemarker Clear Lens w/.156" Bullets                             |       | 100      | 0.156" Bullets             |
| S34-RC00-1  | Red Mini PC Sidemarker Clear Lens w/8.5" wire                                   |   | 100      | Sheathed Pigtail           |
| S34-RC09-1  | Red Mini PC Sidemarker Clear Lens Black Positive 12"wire                        |   | 100      | Sheathed Pigtail           |
| S34-RC0F-1  | Red Mini PC Sidemarker Clear Lens xTM06-2S Connector                            |   | 100      | xTM06-2S                   |
| S34-RC9A-1  | Red Mini PC Sidemarker Clear Lens 12` Wire with .156` Bullets                   |   | 100      | 0.156" Bullets             |
| S34-RC9B-1  | Red Mini PC Sidemarker Clear Lens w/.180 Bullet w/12" wire                      |   | 100      | 0.180" Bullets             |
| S34-RC9H-1  | Red Mini PC Sidemarker Clear Lens 18` Black Positive wire                       |   | 100      | Sheathed Pigtail<br>(18")  |
| S34-RR00-1  | Red Mini PC Sidemarker Red Lens w/8.5" wire                                     |   | 100      | Sheathed Pigtail           |
| S34-RR09-1  | Red Mini PC Sidemarker Red Lens 8.5" wire black positive                        |   | 100      | Sheathed Pigtail           |
| S34-RR0B-1  | Red Mini PC Sidemarker Red Lens w/.180 Bullet 12" wire                          |   | 100      | 0.180" Bullets<br>(12")    |
| S34-RR0C-1  | Red PC sidemarker Red Lens w/2 Pole Connector                                   |   | 100      | 2 Pole                     |
| S34-RR0F-1  | Red Mini PC Sidemarker Red Lens xTM06-2S  |   | 100      | xTM06-2S                   |
| S34-RR20-1  | Red Mini PC Sidemarker Red Lens dual intensity pigtail 6" wire                  |   | 100      | Sheathed Pigtail           |
| S34-RR29A-1 | Red Mini PC Sidemarker Red Lens Dual Intensity 12"                              |   | 100      | Sheathed Pigtail           |
| S34-RR2B-1  | Dual Intensity Red Mini PC Sidemarker Red Lens w/.180 Bullet 6" Wire            |   | 100      | 0.180" Bullets<br>(6")     |
| S34-RR30-1  | Red Mini PC ID Bar Assembly Red Lens 12" Wire lead                              |   | 100      | Sheathed Pigtail<br>(12")  |
| S34-RR31-1  | Red Mini PC ID Bar Assembly Red Lens 48" Wire Lead                              |   | 100      | Sheathed Pigtail<br>(48")  |
| S34-RR39P-1 | Red Mini PC Sidemarker Red Lens Thin Grommet                                    |   | 100      | 0                          |
| S34-RR3F-1  | Red Mini PC ID Bar Assembly Red Lens 12" Wire 2P Deutsch                        |   | 100      | Deutsch Conn<br>(12")      |
| S34-RR30C-1 | Red PC Sidemarker Red Lens w/2 Pole Connector Thin Grommet                      |   | 100      | 2 Pole                     |
| S34-RR49B-1 | Red Mini PC Sidemarker Red Lens w/.180 Bullet 40" wire                          |   | 100      | Sheathed Pigtail<br>(40")  |

































| Part No.                | Part Description   |   | Std Pack | Connector                  |
|-------------------------|--|---|----------|----------------------------|
| S34-RR9B-1              | Red Mini PC Sidemarker Red Lens w/.180 Bullet 12" wire                                     |       | 100      | 0.180" Bullets             |
| S34-RR9F-1              | Red Mini PC Sidemarker Red Lens w 2P Deutsch Conn.   |       | 100      | Deutsch Conn<br>(8.5")     |
| S34-RR9G-1              | Red Mini PC Sidemarker Red Lens 11 inch wire with Ground Ring                              |       | 100      | Pigtail (11")/<br>Gnd Ring |
| S34-RR9H-1              | Red Mini PC Sidemarker Red Lens 18" Black Positive wire                                    |       | 100      | Sheathed Pigtail<br>(18")  |
| S34-RR9L-1              | Red Mini PC Sidemarker Red Lens 11 inch wire   |       | 100      | Pigtail (11")              |
| S34-RR9M-1              | Red Mini PC SM Red Lens Black Positive Wire w/.156" Bullets 8.5"wire                       |       | 100      | 0.156" Bullets             |
| S34-RR9N-1              | Red Mini PC Red Lens Black Positive Wire w .156" Barrels 8.5" wire                         |       | 100      | 0.156" Barrels             |
| S34-RR9U-1              | Red Mini PC SideMarker Amber Lens .156 Barrel w/ Shroud                                    |       | 100      | 0.156" Barrels             |
| S34-RR9HM-1             | Red Mini PC Sidemarker Red Lens 18" wire Lead W/.156 Bullets Black Positive                |       | 100      | Sheathed Pigtail           |
| S34-RRE05-1             | Red Mini PC SM Red Lens 5' Wire  |       | 100      | 0.180" Bullets             |
| S34-RRE20-1             | Red Mini PC SM Red Lens 20' Wire   |       | 100      | 0.180" Bullets             |
| S34-RRE40-1             | Red Mini PC SM Red Lens 40' Wire   |       | 100      | 0.180" Bullets             |
| S34-RRN9-1              | Red Mini PC Sidemarker Red Lens W/ No Sheath NO TIN 8.5" wire                              |       | 100      | Pigtail (9")               |
| S34-RT09-1              | Red Mini PC Sidemarker Tinted Lens w/ 8.5" wire  |       | 100      | Pigtail (9")               |
| S34-WC00-1              | 3/4" Round Mini White Indicator Light 8.5" wire  |       | 100      | Sheathed Pigtail           |
| S34-WC09-1              | 3/4" Round Mini White Indicator Light Black Positive Wire                                  |       | 100      | Sheathed Pigtail           |
| S34-WC0B-1              | 3/4" Round Mini White Indicator Light W/.180 Bullets                                       |       | 100      | 0.180" Bullets             |
| S34-WC0M-1              | 3/4" Round Mini White Indicator Light w/ .156" Bullets 8.5" wire                           |       | 100      | 0.156" Bullets             |
| <b>S36 - Sidemarker</b> |  |   |          |                            |
| S36-AA10-1              | S36 Amber P2 Sidemarker Amber Lens   |   | 100      | Two Pole<br>(S99-3600-1)   |
| S36-AA20-1              | S36 Amber PC Sidemarker Amber Lens   |   | 100      | Two Pole<br>(S99-3600-1)   |
| S36-AC10-1              | S36 Amber PC Sidemarker Clear Lens   |   | 100      | Two Pole<br>(S99-3600-1)   |
| S36-AC20-1              | S36 Amber PC Sidemarker Clear Lens   |   | 100      | Two Pole<br>(S99-3600-1)   |
| S36-RC10-1              | S36 Red PC Sidemarker Clear Lens   |   | 100      | Two Pole<br>(S99-3600-1)   |
| S36-RC20-1              | S36 Red PC Sidemarker Clear Lens   |   | 100      | Two Pole<br>(S99-3600-1)   |
| S36-RR10-1              | S36 Red P2 Sidemarker Red Lens   |   | 100      | Two Pole<br>(S99-3600-1)   |
| S36-RR20-1              | S36 Red PC Sidemarker Red Lens   |   | 100      | Two Pole<br>(S99-3600-1)   |
| <b>S37 - Sidemarker</b> |  |   |          |                            |
| S37-AA09-1              | Amber 3/4 PC Sidemarker Amber Lens 5" Wire White GND                                       |   | 100      | Pigtail (5")               |
| S37-AA90-1              | Amber 3/4 PC Sidemarker Amber Lens 9" Wire   |   | 100      | Pigtail (9")               |
| S37-AA9A-1              | S37 Amber 3/4" PC SM Amber Lens W/.156 Bullet & 5" Wire                                    |   | 100      | 0.156" Bullets             |
| S37-AA9B-1              | Amber 3/4 PC Sidemarker Amber Lens W/.180 Bullet & 5" Wire                                 |   | 100      | 0.180" Bullets             |
| S37-AA9E-1              | AAmber 3/4 PC Sidemarker Amber Lens Black Positive Wire with .156" Bullets & 12" wire      |   | 100      | 0.156" Bullets             |
| S37-AA9H-1              | Amber 3/4 PC Sidemarker Amber Lens 18" Wire W/Sheath                                       |   | 100      | Sheathed Pigtail<br>(18")  |
| S37-AA9N-1              | Amber 3/4 PC Sidemarker Amber Lens Black Positive Wire with .156" Barrels                  |   | 100      | 0.156" Bullets             |
| S37-AA9U-1              | Amber 3/4 PC Sidemarker Amber Lens Black Positive Wire .156 Barrel w/<br>Shroud & 12" Wire |   | 100      | 0.156" Bullets<br>(12")    |
| S37-AAS9V-1             | Amber 3/4 PC Sidemarker Amber Lens W/9" Wire   |   | 100      | Sheathed Pigtail<br>(9")   |
| S37-AC09-1              | Amber 3/4 PC Sidemarker Clear Lens 5" Wire   |   | 100      | Pigtail (5")               |
| S37-AC90-1              | Amber 3/4 PC Sidemarker Clear Lens 9" Wire   |   | 100      | Pigtail (9")               |



| Part No.   | Part Description   |  | Std Pack | Connector               |
|--|--|--|----------|-------------------------|
| S37-AC9B-1   | Amber 3/4 PC Sidemarker Clear Lens W/.180 Bullet Connector 5" Wire                             |  | 100      | 0.180" Bullets (5")     |
| S37-AC9H-1   | Amber 3/4 PC Sidemarker Clear Lens 18" Wire W/Sheath   |  | 100      | Sheathed Pigtail (18")  |
| S37-ACS9V-1  | Amber Mini Grommet Mount PC Sidemarker Clear Lens w/9" Sheathed Wire                           |  | 100      | Sheathed Pigtail (9")   |
| S37-BC09-1   | Blue 3/4 PC Sidemarker Clear Lens 5" Wire  |  | 100      | Pigtail (5")            |
| S37-GC09-1   | Green Mini Grommet Mount Accent Light Clear Lens   |  | 100      | Pigtail (5")            |
| S37-RC09-1   | Red 3/4 PC Sidemarker Clear Lens 5" Wire   |  | 100      | Pigtail (5")            |
| S37-RC90-1   | Red 3/4 PC Sidemarker Clear Lens 9" Wire   |  | 100      | Pigtail (9")            |
| S37-RC9B-1   | Red 3/4 PC Sidemarker Clear Lens W/.180 Bullet Connector & 5" Wire                             |  | 100      | 0.180" Bullets (5")     |
| S37-RC9H-1   | Red 3/4 PC Sidemarker Clear Lens 18" Wire W/Sheath   |  | 100      | Pigtail (18")           |
| S37-RCS9V-1  | Red Mini Grommet Mount PC Side Marker Clear Lens w/ 9" Sheathed Wire                           |  | 100      | Sheathed Pigtail (9")   |
| S37-RR09-1   | Red 3/4 PC Sidemarker Red Lens 5" Wire White GND   |  | 100      | Pigtail (5")            |
| S37-RR19G-1  | Red 3/4 PC Sidemarker Red Lens 9in Wire w Ground Ring  |  | 100      | Pigtail (9")            |
| S37-RR90-1   | Red 3/4 PC Sidemarker Red Lens 9" Wire   |  | 100      | Pigtail (9")            |
| S37-RR9A-1   | S37 Red 3/4" PC SM Red Lens W/.156 Bullet & 5" Wire  |  | 100      | 0.156" Bullets          |
| S37-RR9B-1   | Red 3/4 PC Sidemarker Red Lens W/.180 Bullet & 5" Wire   |  | 100      | 0.180" Bullets          |
| S37-RR9E-1   | Red 3/4 PC Sidemarker Red Lens Black Positive Wire with .156" Bullets & 12" wire               |  | 100      | 0.156" Bullets          |
| S37-RR9H-1   | Red 3/4 PC Sidemarker Red Lens 18" Wire W/Sheath   |  | 100      | Sheathed Pigtail (18")  |
| S37-RR9N-1   | Red 3/4 PC Sidemarker Red Lens Black Positive Wire with .156" Barrel                           |  | 100      | 0.156" Bullets          |
| S37-RR9U-1   | Red 3/4 PC Sidemarker Red Lens Black Positive .156 Barrel w/ Shroud & 12" Wire                 |  | 100      | 0.156" Bullets (12")    |
| S37-RRS9V-1  | Red 3/4 PC Sidemarker Red Lens W/9" Wire   |  | 100      | Sheathed Pigtail (9")   |
| S37-WC09-1   | White 3/4 PC Sidemarker Clear Lens 5" Wire White GND   |  | 100      | Pigtail (5")            |
| S37-WC9H-1   | White 3/4 PC Sidemarker Clear Lens 18" Wire W/Sheath   |  | 100      | Sheathed Pigtail (18")  |
| <b>S38 - Sidemarker</b>                            |  |  |          |                         |
| S38-0G00-1   | Overmolded Gasket  |  | 100      | -                       |
| S38-AA09-1   | Amber Mini Surface PC Sidemarker Amber Lens 5" wire  |  | 100      | Sheathed Pigtail        |
| S38-AAG0-1   | Amber Mini Surface PC Sidemarker Amber Lens 5" wire Self Grounding                             |  | 100      | Pigtail / Self grounded |
| S38-AC09-1   | Amber Mini Surface PC Sidemarker Clear Lens 5" wire  |  | 100      | Sheathed Pigtail        |
| S38-ACG0-1   | Amber Mini Surface PC Sidemarker Clear Lens 5" wire Self Grounding                             |  | 100      | Pigtail / Self grounded |
| S38-BC09-1   | Blue Mini Surface PC Sidemarker Clear Lens 5" wire   |  | 100      | Sheathed Pigtail        |
| S38-GC09-1   | Green Mini Surface Mount Accent Light Clear Lens <i>*Please contact us for min. quantities</i> |  | 100      | Sheathed Pigtail        |
| S38-RC09-1   | Red Mini Surface PC Sidemarker Clear Lens 5" wire  |  | 100      | Sheathed Pigtail        |
| S38-RCG0-1   | Red Mini Surface PC Sidemarker Clear Lens 5" wire Self Grounding                               |  | 100      | Pigtail / Self grounded |
| S38-RR09-1   | Red Mini Surface PC Sidemarker Red Lens 5" wire  |  | 100      | Sheathed Pigtail        |
| S38-RRG0-1   | Red Mini Surface PC Sidemarker Red Lens 5" wire Self Grounding                                 |  | 100      | Pigtail / Self grounded |
| S38-WC09-1   | White Mini Surface PC Sidemarker Clear Lens 5" wire  |  | 100      | Sheathed Pigtail        |
| <b>S39 - Adhesive Mounted PC Rated Side Marker</b> |  |  |          |                         |
| S39-AA00-1   | S39 Amber Sidemarker Amber Len   |  | 100      | Pigtail (9")            |
| S39-RR00-1   | S39 Red Sidemarker Red Lens  |  | 100      | Pigtail (9")            |
| <b>S50 - Heavy Duty ID Bar</b>                     |  |  |          |                         |







































| Part No.  | Part Description  |   | Std Pack | Connector                   |
|---|---|---|----------|-----------------------------|
| S50-AAB0-1  | S50 Tri-Bar Amber Amber Lens Black Body                       |    | 25       | Sheathed Pigtail            |
| S50-ACB0-1  | Tri-Bar Amber Clear Lens Black Body                           |    | 25       | Sheathed Pigtail            |
| S50-RCB0-1  | Tri-Bar Red Clear Lens Black Body                             |    | 25       | Sheathed Pigtail            |
| S50-RRB0-1  | S50 Tri-Bar Red Red Lens Black Body                           |    | 25       | Sheathed Pigtail            |
| S50-RRBG-1  | S50 Tri-Bar Red Red Lens Black Body with #10 Ground Ring      |    | 25       | Sheathed Pigtail            |
| <b>S51 - Heavy Duty ID Bar</b>                          |   |   |          |                             |
| S51-AA00-1  | S51 Tri-Bar Amber Amber Lens Black Body S18 Markers           |    | 25       | Sheathed Pigtail            |
| S51-AAG0-1  | S51 Tri-Bar Amber Lens Grey Body S18 Markers                  |    | 25       | Sheathed Pigtail            |
| S51-AC00-1  | S51 Tri-Bar Amber Clear Lens Black Body S18 Markers           |    | 25       | Sheathed Pigtail            |
| S51-RC00-1  | S51 Tri-Bar Red Clear Lens Black Body S18 Markers             |    | 25       | Sheathed Pigtail            |
| S51-RR00-1  | S51 Tri-Bar Red Red Lens Black Body S18 Markers               |    | 25       | Sheathed Pigtail            |
| S51-RRG0-1  | S51 Tri-Bar Red Red Lens Grey Body S18 Markers                |    | 25       | Sheathed Pigtail            |
| <b>S52 - V-shaped ID Bar</b>                            |   |   |          |                             |
| S52-RC00-1  | Red ID Bar with Clear Lens V Shape Pigtail                    |    | 25       | Sheathed Pigtail            |
| S52-RC10-1  | Red ID Bar with Clear Lens V Shape W/58" Lead                 |    | 25       | Pigtail (58")               |
| S52-RR00-1  | Red ID Bar with Red Lens V Shape Pigtail                      |    | 25       | Sheathed Pigtail            |
| S52-RR10-1  | Red ID Bar with Red Lens V Shape W/58" Lead                   |    | 25       | Pigtail (58")               |
| <b>S90 - Heavy Duty Miniature Bi-color Fender Light</b> |   |   |          |                             |
| S90-0000-1  | Fender Sidemarker Light                                       |    | 150      | Pigtail (9")                |
| S90-000M-1  | Fender Sidemarker Light W/.156 Bullet                         |  | 150      | 0.156" Bullet               |
| S90-0010-1  | Fender Sidemarker Light 20" Wire                              |  | 150      | Pigtail (20")               |
| S90-002B-1  | Fender Sidemarker Light 20" Wire w/ 1/4" Ring & .180 Bullet   |  | 150      | 0.180" Bullet / Ground Ring |
| S90-00D0-1  | S90 Dual Intensity Fender SM Light                            |  | 150      | Pigtail (9")                |
| S90-00G0-1  | Fender Sidemarker Light Self Grounding                        |  | 150      | Pigtail (9") / Ground Ring  |
| S90-00GB-1  | Fender Sidemarker Light Self Grounding w/.180 bullet          |  | 150      | -                           |
| S90-0B00-1  | Fender Sidemarker Light Wire Guide Black 2 Screw              |   | 150      | -                           |
| S90-0B05-1  | Fender Sidemarker Light Wire Guide Black - 5" Length          |   | 150      | -                           |
| S90-0B20-1  | S90 Wall Cover Black  |   | 150      | -                           |
| S90-0B30-1  | Fender Sidemarker Light SS Stamping W/Black Powder Coat       |   | 150      | -                           |
| S90-0BH0-1  | Fender Sidemarker Light Wire Guide Black 6.5" Length 4 Screw  |   | 150      | -                           |
| S90-0BS0-1  | Fender Sidemarker Light Wire Guide Black 4 Screw Full length  |   | 150      | -                           |
| S90-0C00-1  | Fender Sidemarker Light Wire Guide Chrome 2 Screw             |   | 150      | -                           |
| S90-0C20-1  | Fender Sidemarker Wall Cover Chrome                           |   | 150      | -                           |
| S90-0CH0-1  | Fender Sidemarker Light Wire Guide Chrome 6.5" Length 4 Screw |   | 150      | -                           |
| S90-0CS0-1  | Fender Sidemarker Light Wire Gu Chrome 4 Screw Full Length    |   | 150      | -                           |
| S90-0SS0-1  | Fender Sidemarker Light SS Stamping                           |   | 150      | -                           |
| S90-0T00-1  | Fender Sidemarker Light Tinted Lens.                          |  | 150      | -                           |
| S90-0TGO-1  | Fender Sidemarker Light Tinted Lens Self Ground               |  | 150      | -                           |
| <b>S91 - Heavy Duty Miniature Bi-color Fender Light</b> |   |   |          |                             |







































































| Part No.                                   | Part Description   |  | Std Pack | Connector                 |
|--|--|--|----------|---------------------------|
| S91-0B10-1                                 | Fender light wire guide 7.5" black                                 |  | 100      | -                         |
| S91-AR00-1                                 | Fender Light Amber Red Lens Pigtail                                |                                       | 100      | Pigtail (6")              |
| S91-AR01-1                                 | Fender Light Amber Red Lens Pigtail 11in wire                      |                                       | 100      | Pigtail (11")             |
| S91-ARC0-1                                 | Fender Light Clear Lens Pigtail                                    |                                       | 100      | Pigtail (6")              |
| <b>T1x - Low Profile Tail Light/ID Bar</b> |  |  |          |                           |
| T10-0B00-1                                 | T10 Black Trim Ring  |  | 100      | -                         |
| T10-0C00-1                                 | T10 Chrome Trim Ring   |  | 100      | -                         |
| T10-0G00-1                                 | T10 Noeprene gasket  |  | 100      | -                         |
| T10-AA00-1                                 | Amber Low Profile Turn Sidemarker Amber Lens                       |                                       | 100      | Pigtail                   |
| T10-AC00-1                                 | Amber Low Profile Turn Sidemarker Clear Lens                       |                                       | 100      | Pigtail                   |
| T10-AC0F-1                                 | Amber Low Profile Turn Sidemarker Clear Lens w xTM06-3S Connector  |                                       | 100      | 0                         |
| T10-LC00-1                                 | Low Profile Auxiliary Light  |                                       | 100      | Pigtail                   |
| T10-LC0B-1                                 | Low Profile Auxiliary Light w/ .180 bullet                         |                                       | 100      | 0.180" Bullets            |
| T10-LC0M-1                                 | Low Profile Auxiliary Light w/ .156 bullets (black wire is ground) |                                       | 100      | 0.156" Bullets            |
| T10-LC9M-1                                 | Low Profile Auxiliary Light w/.156" Bullets                        |                   | 100      | 0.156" Bullets            |
| T10-RC00-1                                 | Red Low Profile STT Clear Lens                                     |                                       | 100      | Pigtail                   |
| T10-RC0B-1                                 | Red Low Profile STT Clear Lens w/.180" Bullets                     |                   | 100      | Pigtail                   |
| T10-RC0F-1                                 | Red Low Profile STT Clear Lens w xTM06-3S Connector                |                                       | 100      | 0                         |
| T10-RC0M-1                                 | Red Low Profile STT Clear Lens w/.156" Bullets                     |                   | 100      | 0.156" Bullets            |
| T10-RR00-1                                 | Red Low Profile STT Red Lens                                       |                                     | 100      | Pigtail                   |
| T10-RR0B-1                                 | Red Low Profile STT Red Lens Pigtail w/ 0.180" Bullets             |                 | 100      | 0.180" Bullets            |
| T10-RR0M-1                                 | Red Low Profile STT Red Lens w/.156" Bullets                       |                 | 100      | 0.156" Bullets            |
| T10-RR0T-1                                 | Red Low Profile STT Red Lens w/.156" Barrels w/ grease             |  | 100      | 0.156" Barrels            |
| T10-RT00-1                                 | Red Low Profile STT Tinted Lens                                    |                                     | 100      | Pigtail                   |
| T11-RC00-1                                 | Red Low Profile Third Brake Clear Lens                             |                                     | 100      | Pigtail                   |
| T11-RR00-1                                 | Red Low Profile Third Brake Red Lens                               |                                     | 100      | Pigtail                   |
| T12-AA00-1                                 | Amber Low Profile ID Bar Amber Lens                                |                                     | 100      | Pigtail                   |
| T12-AC00-1                                 | Amber Low Profile ID Bar Clear Lens                                |                                     | 100      | Pigtail                   |
| T12-RC00-1                                 | Red Low Profile ID Bar Clear Lens                                  |                                     | 100      | Pigtail                   |
| T12-RC0B-1                                 | Red Low Profile ID Bar Clear Lens PigTail w/.180" Bullets          |                 | 100      | Pigtail                   |
| T12-RC0M-1                                 | Red Low Profile ID Bar Clear Lens w/.156 Bullets                   |                                     | 100      | 0.156" Bullets            |
| T12-RC0T-1                                 | Red Low Profile ILD Bar Clear Lens .156" Barrels w/ grease         |  | 100      | 0.156" Barrels            |
| T12-RR00-1                                 | Red Low Profile ID Bar Red Lens                                    |                                     | 100      | Pigtail                   |
| T12-RR0B-1                                 | Red Low Profile ID Bar Red Lens PigTail w/.180" Bullets            |                 | 100      | 0.180" Bullets            |
| T12-RR0G-1                                 | Red Low Profile ID Bar Red Lens W/Ground Ring                      |                                     | 100      | Pigtail w/<br>Ground Ring |
| T12-RR0M-1                                 | Red Low Profile ID Bar Red Lens w/.156 Bullets                     |                                     | 100      | 0.180" Bullets            |
| T12-RT00-1                                 | Red Low Profile ID Bar Tinted Lens                                 |                                     | 100      | Pigtail                   |
| T12-RW00-1                                 | Red ID Bar/Load Lamp Clear Lens                                    |                                     | 100      | Pigtail                   |
| T13-AA00-1                                 | Amber Low Profile ID/Turn Bar Amber Lens                           |                                     | 100      | Pigtail                   |







































































| Part No.                             | Part Description  |   | Std Pack | Connector      |
|--------------------------------------|---|---|----------|----------------|
| T13-RC00-1                           | Red Low Profile Turn/ID Bar Clear Lens                        |    | 100      | Pigtail        |
| T13-RR00-1                           | Red Low Profile Turn/ID Bar Red Lens                          |    | 100      | Pigtail        |
| T14-RT00-1                           | Identification and Load Lamp Combo - Tinted                   |    | 100      | Pigtail        |
| T14-RW00-1                           | Identification and Load Lamp Combo                            |    | 100      | Pigtail        |
| T15-RCW0-1                           | Low profile Red LED Clear Lens with Reverse                   |    | 100      | Pigtail        |
| T15-RCWB-1                           | Low profile Red LED Clear Lens with Reverse with .180 bullets |    | 100      | 0.180" Bullets |
| T15-RWTP-1                           | Low Profile Red Tinted Lens with Reverse                      |    | 100      | Pigtail        |
| T16-RC00-1                           | 20" slim profile clear lens STT                               |    | 100      | Pigtail        |
| T16-RCW0-1                           | 20" slim profile clear lens STTR                              |    | 100      | Pigtail        |
| T16-RR00-1                           | 20" slim profile Red lens STT                                 |    | 100      | Pigtail        |
| T16-RT00-1                           | 20" Slim Profile Tinted Lens STT                              |    | 100      | Pigtail        |
| T16-RWT0-1                           | 20" Slim Profile Tinted Lens STTR                             |    | 100      | Pigtail        |
| <b>T23 - Load Lamp</b>               |   |   |          |                |
| T23-4F0F-1                           | 4-Color Indicator Light 12v w/ xTM06-6S                       |    | TBD      | Deutsch        |
| T23-4F10-1                           | Load Lamp pigtail wires                                       |    | TBD      | Pigtail (9")   |
| T23-4F1F-1                           | Load Lamp Deutch DTM06-6S                                     |    | TBD      | Deutsch        |
| <b>T40 - 4" Round Stop-Turn-Tail</b> |   |   |          |                |
| T40-0G00-1                           | 4" Round Grommet  |   | 100      | -              |
| T40-0G20-1                           | 4" Round Grommet High Grip                                    |   | 100      | -              |
| T40-0GG0-1                           | 4" Round Adhesive Flange Gasket                               |   | 100      | -              |
| T40-0S00-1                           | 4" Round Trim Ring SS   |   | 100      | -              |
| T40-AA0A-1                           | 4" Round Amber Turn Lamp Amber Lens                           |  | 100      | Amp            |
| T40-AA0P-1                           | 4" Round Amber Turn Lamp Amber Lens w/Pig Tail                |  | 100      | Pigtail        |
| T40-AA0T-1                           | 4" Round Amber Turn Lamp Amber Lens 3 Pole                    |  | 100      | Tri Pole       |
| T40-AAFA-1                           | 4" Round Amber Turn Lamp Amber Lens Flange Mount              |  | 100      | Amp            |
| T40-AAFB-1                           | 4" Round Amber Turn Lamp Amber Lens Flange 0.180 Bullet       |  | 100      | 0.180" Bullets |
| T40-AAFP-1                           | 4" Round Amber Turn Lamp Amber Lens Flange Mount w/Pig Tail   |  | 100      | Pigtail        |
| T40-AAFT-1                           | 4" Round Amber Turn Lamp Amber Lens Flange Mount 3 Pole       |  | 100      | Tri Pole       |
| T40-AC0A-1                           | 4" Round Amber Turn Lamp Clear Lens                           |  | 100      | Amp            |
| T40-AC0P-1                           | 4" Round Amber Turn Lamp Clear Lens w/Pig Tail                |  | 100      | Pigtail        |
| T40-AC0T-1                           | 4" Round Amber Turn Lamp Clear Lens 3 Pole                    |  | 100      | Tri Pole       |
| T40-ACFA-1                           | 4" Round Amber Turn Lamp Clear Lens Flange Mount              |  | 100      | Amp            |
| T40-ACFP-1                           | 4" Round Amber Turn Lamp Clear Lens Flange Mount w/Pig Tail   |  | 100      | Pigtail        |
| T40-ACFT-1                           | T64" Round Amber Turn Lamp Clear Lens Flange Mount 3 Pole     |  | 100      | Tri Pole       |
| T40-RC0A-1                           | 4" Round STT Lamp Clear Lens Amp                              |  | 100      | Amp            |
| T40-RC0P-1                           | 4" Round STT Lamp Clear Lens w/Pig Tail                       |  | 100      | Pigtail        |
| T40-RC0T-1                           | 4" Round STT Lamp Clear Lens 3 Pole                           |  | 100      | Tri Pole       |
| T40-RCFA-1                           | 4" Round STT Lamp Clear Lens Flange Mount                     |  | 100      | Amp            |
| T40-RCFP-1                           | 4" Round STT Clear Lens Flange Mount w/Pig Tail               |  | 100      | Pigtail        |













































































| Part No.   | Part Description   |             | Std Pack       | Connector                |
|--|--|-------------|----------------|--------------------------|
| T40-RCFT-1   | 4" Round STT Lamp Clear Lens Flange Mount 3 Pole           |             | 100            | Tri Pole                 |
| <del>T40-RR00-1</del>  | <del>4" Round STT Lamp Red Lens Amp</del>                  | <del></del> | <del>100</del> | <del>Amp</del>           |
| T40-RR0A-1   | 4" Round STT Lamp Red Lens Amp                             |             | 100            | Amp                      |
| T40-RR0B-1   | 4" Round STT Lamp Red Lens Pig Tail w/.180 Bullet          |             | 100            | 0.180" Bullets           |
| T40-RR0P-1   | 4" Round STT Lamp Red Lens w/Pig Tail                      |             | 100            | Pigtail                  |
| T40-RR0T-1   | 4" Round STT Lamp Red Lens 3 Pole                          |             | 100            | Tri Pole                 |
| T40-RRFA-1   | 4" Round STT Red Lens Flange Mount Amp                     |             | 100            | Amp                      |
| T40-RRFB-1   | 4" Round STT Lamp Red Lens Pig Tail w/.180 Bullet w/flange |             | 100            | 0.180" Bullets           |
| T40-RRFP-1   | 4" Round STT Red Lens Flange Mount w/Pig Tail              |             | 100            | Pigtail                  |
| T40-RRFT-1   | 4" Round STT Red Lens Flange Mount 3 Pole                  |             | 100            | Tri Pole                 |
| <b>T41 - 4" Round Reverse Lamp</b>                                     |  |             |                |                          |
| T41-WC0A-1   | 4" Round 2x Reverse Lamp Grommet Amp                       |             | 100            | Amp                      |
| T41-WC0B-1   | 4" Round 2X Reverse Lamp Grommet Bullet                    |             | 100            | 0.180" Bullets           |
| T41-WC0P-1   | 4" Round 2x Reverse Lamp Grommet w/Pig Tail                |             | 100            | Pigtail                  |
| T41-WC0T-1   | 4" Round 2x Reverse Lamp Grommet 3 Pole                    |             | 100            | Tri Pole                 |
| T41-WCFA-1   | 4" Round Reverse Lamp Clear Lens Flange Mount Amp          |             | 100            | Amp                      |
| T41-WCFP-1   | 4" Round Reverse Lamp Clear Lens Flange Mount Pigtail      |             | 100            | Pigtail                  |
| T41-WCFT-1   | 4" Round Reverse Lamp Clear Lens Flange Mount 3 Pole       |             | 100            | Tri Pole                 |
| <b>T42 - 4" Round STTR</b>   |  |             |                |                          |
| T42-RW0A-1   | 4" Round STTR Clear Lens Grommet Mount Amp                 |             | 100            | Amp                      |
| T42-RW0T-1   | 4" Round STTR w Large Reverse Grommet Mount Tripole        |             | 100            | Tri Pole                 |
| <b>T44 - 4" Interior Dome Light</b>                                    |  |             |                |                          |
| T44-WD0B-1   | 4" Round Dome Light 0.180 bullets                          |             | 100            | 0.180" Bullets           |
| T44-WDFB-1   | 4" Round Dome Light Flange Mount w/ 0.180 bullets          |             | 100            | 0.180" Bullets           |
| T44-WDFBS-1  | 4" Round Dome Light Flange Mount w 0.180" bullet/barrel    |             | 100            | 0.180" Bullet/<br>Barrel |
| <b>T45 - 4" Round Hi Visibility Stop/Turn/Tail/Reverse Combo Light</b> |  |             |                |                          |
| T45-RC0A-1   | 4" Round STTR Clear Lens Grommet Mount Amp                 |             | 100            | Amp                      |
| T45-RC0P-1   | 4" Round STTR Clear Lens Grommet Mount Pigtail             |             | 100            | Pigtail                  |
| T45-RC0T-1   | 4" Round STTR Clear Lens Grommet Mount Tri-Pole            |             | 100            | Tri Pole                 |
| T45-RCFA-1   | 4" Round STTR Clear Lens Flush Mount Amp                   |             | 100            | Amp                      |
| T45-RCFP-1   | 4" Round STTR Clear Lens Flush Mount Pigtail               |             | 100            | Pigtail                  |
| T45-RCFT-1   | 4" Round STTR Clear Lens Flush Mount Tri-Pole              |             | 100            | Tri Pole                 |
| T45-RW0A-1   | 4" Round STTR Red Lens Grommet Mount Amp                   |             | 100            | Amp                      |
| T45-RW0P-1   | 4" Round STTR Red Lens Grommet Mount Pigtail               |             | 100            | Pigtail                  |
| T45-RW0T-1   | 4" Round STTR Red Lens Grommet Mount Tripole               |             | 100            | Tri Pole                 |
| T45-RWFA-1   | 4" Round STTR Red Lens Flush Mount Amp                     |             | 100            | Amp                      |
| T45-RWFB-1   | 4" Round STTR Red Lens Flush Mount w/ .180 Bullet          |             | 100            | 0.180" Bullets           |
| T45-RWFP-1   | 4" Round STTR Red Lens Flush Mount Pigtail                 |             | 100            | Pigtail                  |
| T45-RWFT-1   | 4" Round STTR Red Lens Flush Mount Tri-Pole                |             | 100            | Tri Pole                 |





































| Part No.   | Part Description   |   | Std Pack | Connector      |
|--|--|---|----------|----------------|
| <b>T46 - 4" Round Hi Visibility Stop/Turn/Tail</b> |  |   |          |                |
| T46-AA0A-1   | Hi Visibility 4" Round Amber STT Amber Lens Amp Conn. Grommet Mt           |    | 100      | Amp            |
| T46-AA0P-1   | Hi Visibility 4" Round Amber STT Amber Lens Pigtail Conn. Grommet Mt       |    | 100      | Pigtail        |
| T46-AA0T-1   | Hi Visibility 4" Round Amber STT Amber Lens Tri Pole Conn. Grommet Mt      |    | 100      | Tri Pole       |
| T46-AAFA-1   | High Visibility 4" Round Amber STT Amber Lens Flange Mount Amp             |    | 100      | Amp            |
| T46-AAZ0A-1  | High Visibility Amber 4" Round Strobe Amber Lens Grommet Amp Connector     |    | 100      | Amp            |
| T46-AAZ0B-1  | High Visibility Amber 4" Round Strobe Amber Lens Grommet Bullet Connector  |    | 100      | 0.180" Bullets |
| T46-AAZ0P-1  | High Visibility Amber 4" Round Strobe Amber Lens Grommet Pigtail Connector |    | 100      | Pigtail        |
| T46-AAZ0T-1  | High Visibility Amber 4" Round Strobe Amber Lens Grommet Tripole Connector |    | 100      | Tri Pole       |
| T46-AAZFA-1  | High Visibility Amber 4" Round Strobe Amber Lens Flange Amp Connector      |    | 100      | Amp            |
| T46-AAZFB-1  | High Visibility Amber 4" Round Strobe Amber Lens Flange Bullet Connector   |    | 100      | 0.180" Bullets |
| T46-AAZFP-1  | High Visibility Amber 4" Round Strobe Amber Lens Flange Pigtail Connector  |    | 100      | Pigtail        |
| T46-AAZFT-1  | High Visibility Amber 4" Round Strobe Amber Lens Flange Tripole Connector  |    | 100      | Tri Pole       |
| T46-AC0A-1   | Hi Visibility 4" Round Amber STT Clear Lens Amp Conn. Grommet Mt           |    | 100      | Amp            |
| T46-AC0P-1   | Hi Visibility 4" Round Amber STT Clear Lens Pigtail Conn. Grommet Mt       |    | 100      | Pigtail        |
| T46-AC0T-1   | Hi Visibility 4" Round Amber STT Clear Lens Tri Pole Conn. Grommet Mt      |    | 100      | Tri Pole       |
| T46-ACZ0A-1  | High Visibility Amber 4" Round Strobe Clear Lens Grommet Amp Connector     |    | 100      | Amp            |
| T46-ACZ0B-1  | High Visibility Amber 4" Round Strobe Clear Lens Grommet Bullet Connector  |    | 100      | 0.180" Bullets |
| T46-ACZ0P-1  | High Visibility Amber 4" Round Strobe Clear Lens Grommet Pigtail Connector |   | 100      | Pigtail        |
| T46-ACZ0T-1  | High Visibility Amber 4" Round Strobe Clear Lens Grommet Tripole Connector |  | 100      | Tri Pole       |
| T46-ACZFA-1  | High Visibility Amber 4" Round Strobe Clear Lens Flange Amp Connector      |  | 100      | Amp            |
| T46-ACZFB-1  | High Visibility Amber 4" Round Strobe Clear Lens Flange Bullet Connector   |  | 100      | 0.180" Bullets |
| T46-ACZFP-1  | High Visibility Amber 4" Round Strobe Clear Lens Flange Pigtail Connector  |  | 100      | Pigtail        |
| T46-ACZFT-1  | High Visibility Amber 4" Round Strobe Clear Lens Flange Tripole Connector  |  | 100      | Tri Pole       |
| T46-RC0A-1   | Hi Visibility 4" Round STT Clear Lens Amp Grommet Mt                       |  | 100      | Amp            |
| T46-RC0P-1   | Hi Visibility 4" Round STT Clear Lens Pigtail Connector Grommet Mount      |  | 100      | Pigtail        |
| T46-RC0T-1   | Hi Visibility 4" Round STT Clear Lens Tri Pole Grommet Mt                  |  | 100      | Tri Pole       |
| T46-RCFA-1   | Hi Visibility 4" Round STT Clear Lens Amp Flange Mt                        |  | 100      | Amp            |
| T46-RCFT-1   | Hi Visibility 4" Round STT Clear Lens Tri Pole Flange Mt                   |  | 100      | Tri Pole       |
| T46-RR0A-1   | Hi Visibility 4" Round STT Red Lens Amp Grommet Mt                         |  | 100      | Amp            |
| T46-RR0P-1   | Hi Visibility 4" Round STT Red Lens Pigtail Connector Grommet Mount        |  | 100      | Pigtail        |
| T46-RR0T-1   | Hi Visibility 4" Round STT Red Lens Tri Pole Grommet Mt                    |  | 100      | Tri Pole       |
| T46-RRFA-1   | Hi Visibility 4" Round STT Red Lens Amp Flange Mt                          |  | 100      | Amp            |
| T46-RRFT-1   | Hi Visibility 4" Round STT Red Lens Tri Pole Flange Mt                     |  | 100      | Tri Pole       |
| T46-WC0A-1   | Hi Visibility 4" Round Reverse Clear Lens Grommet Mount Amp Connector      |  | 100      | Amp            |
| T46-WC0A-1   | Hi Visibility 4" Round Reverse Clear Lens Grommet Mount Amp Connector      |  | 100      | Amp            |
| T46-WC0P-1   | Hi Visibility 4" Round Reverse Clear Lens Grommet Mount Pigtail Connector  |  | 100      | Pigtail        |
| T46-WC0T-1   | Hi Visibility 4" Round Reverse Clear Lens Grommet Mount Tripole Connector  |  | 100      | Tri Pole       |
| T46-WCFA-1   | Hi Visibility 4" Round Reverse Clear Lens Flange Mount Amp Connector       |  | 100      | Amp            |



































| Part No.  | Part Description   |  | Std Pack       | Connector           |
|---|--|--|----------------|---------------------|
| T46-WCFP-1  | Hi Visibility 4" Round Reverse Clear Lens Flange Mount Pigtail Connector     |              | 100            | Pigtail             |
| T46-WCFT-1  | Hi Visibility 4" Round Reverse Clear Lens Flange Mount Tripole Connector     |              | 100            | Tri Pole            |
| <b>T60 - 6" Grommet Mount Oval Stop-Turn-Tail</b> |  |  |                |                     |
| T60-0G00-1  | 6" Oval Grommet  |  | -              | -                   |
| T60-AAHA-1  | Amber Turn Horiz. Grommet Mnt Amber Lens Amp Connect                         |              | 100            | Amp                 |
| T60-AAHP-1  | 6" Oval Amber Turn Horiz. Grommet Mnt Amber Lens Pig Tail                    |              | 140            | Pigtail             |
| T60-AAHT-1  | 6" Oval Amber Turn Horiz. Grommet Mnt Amber Lens 3 Pole                      |              | 100            | Tri Pole            |
| T60-AAVA-1  | 6" Oval Amber Turn Vert. Grommet Mnt Amber Lens Amp Connect                  |              | 100            | Amp                 |
| T60-AAVP-1  | 6" Oval Amber Turn Vertical Grommet Mnt Amber Lens Pig Tail                  |              | 140            | Pigtail             |
| T60-AAVT-1  | 6" Oval Amber Turn Vertical Grommet Mnt Amber Lens 3 Pole                    |              | 100            | Tri Pole            |
| <del>T60-AAZHA-1</del>                            | <del>6" Oval Amber Strobe Horiz. Grommet Mt Amber Lens Amp Connector</del>   | <del> </del> | <del>100</del> | <del>Amp</del>      |
| <del>T60-AAZHP-1</del>                            | <del>6" Oval Amber Strobe Horiz. Grommet Mnt Amber Lens Pig Tail</del>       | <del> </del> | <del>140</del> | <del>Pigtail</del>  |
| <del>T60-AAZHT-1</del>                            | <del>6" Oval Amber Strobe Horiz. Grommet Mnt Amber Lens 3 Pole</del>         | <del> </del> | <del>100</del> | <del>Tri Pole</del> |
| <del>T60-AAZVA-1</del>                            | <del>6" Oval Amber Strobe Vertical Grommet Mt Amber Lens Amp Connector</del> | <del> </del> | <del>100</del> | <del>Amp</del>      |
| <del>T60-AAZVP-1</del>                            | <del>6" Oval Amber Strobe Vertical Grommet Mnt Amber Lens Pig Tail</del>     | <del> </del> | <del>140</del> | <del>Pigtail</del>  |
| <del>T60-AAZVT-1</del>                            | <del>6" Oval Amber Strobe Vertical Grommet Mnt Amber Lens 3 Pole</del>       | <del> </del> | <del>100</del> | <del>Tri Pole</del> |
| T60-ACHA-1  | 6" Oval Amber Turn Horiz. Grommet Mount Clear Lens Amp                       |              | 100            | Amp                 |
| T60-ACHP-1  | 6" Oval Amber Turn Horiz. Grommet Mount Clear Lens Pig Tail                  |              | 140            | Pigtail             |
| T60-ACHT-1  | 6" Oval Amber Turn Horiz. Grommet Mount Clear Lens 3 Pole                    |            | 100            | Tri Pole            |
| T60-ACVA-1  | 6" Oval Amber Turn Vertical Grommet Mount Clear Lens Amp Connector           |          | 100            | Amp                 |
| T60-ACVP-1  | 6" Oval Amber Turn Vertical Grommet Mnt Clear Lens Pig Tail                  |          | 140            | Pigtail             |
| T60-ACVT-1  | 6" Oval Amber Turn Vertical Grommet Mnt Clear Lens 3 Pole                    |          | 100            | Tri Pole            |
| T60-RCHA-1  | 6" Oval Red STT Horiz. Grommet Mount Clear Lens Amp                          |          | 100            | Amp                 |
| T60-RCHP-1  | 6" Oval Red STT Horiz. Grommet Mount Clear Lens Pig Tail                     |          | 140            | Pigtail             |
| T60-RCHT-1  | 6" Oval Red STT Horiz. Grommet Mount Clear Lens 3 Pole                       |          | 100            | Tri Pole            |
| T60-RCVA-1  | 6" Oval Red STT Vertical Grommet Mount Clear Lens Amp                        |          | 100            | Amp                 |
| T60-RCVP-1  | 6" Oval Red STT Vertical Grommet Mount Clear Lens Pig Tail                   |          | 140            | Pigtail             |
| T60-RCVT-1  | 6" Oval Red STT Vertical Grommet Mount Clear Lens 3 Pole                     |          | 100            | Tri Pole            |
| T60-RRHA-1  | 6" Oval Red STT Horiz. Grommet Mount Red Lens Amp                            |          | 100            | Amp                 |
| T60-RRHB-1  | 6" Oval Red STT Horiz. Grommet Mount Red Lens w/.180" Bullet                 |          | 140            | 0.180" Bullets      |
| T60-RRHP-1  | 6" Oval Red STT Horiz. Grommet Mount Red Lens Pig Tail                       |          | 140            | Pigtail             |
| T60-RRHT-1  | 6" Oval Red STT Horiz. Grommet Mount Red Lens 3 Pole                         |          | 100            | Tri Pole            |
| T60-RRVA-1  | 6" Oval Red STT Vertical Grommet Mount Red Lens Amp                          |          | 100            | Amp                 |
| T60-RRVP-1  | 6" Oval Red STT Vertical Grommet Mount Red Lens Pig Tail                     |          | 140            | Pigtail             |
| T60-RRVT-1  | 6" Oval Red STT Vertical Grommet Mount Red Lens 3 Pole                       |          | 100            | Tri Pole            |
| T60-WCHP-1  | 6" Oval White Light  |          | 140            | Pigtail             |
| T60-WCVA-1  | 6" Oval Vertical Mount Reverse Lamp  |          | 100            | Amp                 |
| <b>T61 - Surface mount Oval Stop-Turn-Tail</b>    |  |  |                |                     |
| T61-0B00-1  | 6" Oval Surface Mount Trim Ring Black  |  | -              | -                   |







































































| Part No.                           | Part Description  |   | Std Pack | Connector      |
|------------------------------------|---|---|----------|----------------|
| T61-0C00-1                         | 6" Oval Surface Mount Trim Ring Chrome                            |   | -        | -              |
| T61-0G00-1                         | .090 Thick Neoprene Gasket  |   | -        | -              |
| T61-AAHA-1                         | 6" Oval Amber Turn Horiz. Surface Mount Amber Lens Amp            |       | 120      | Amp            |
| T61-AAHP-1                         | 6" Oval Amber Turn Horiz. Surface Mount Amber Lens Pig Tail       |       | 140      | Pigtail        |
| T61-AAHT-1                         | 6" Oval Amber Turn Horiz. Surface Mount Amber Lens 3 Pole         |       | 120      | Tri Pole       |
| T61-AAVA-1                         | 6" Oval Amber STT Vertical Surface Mount Amber Lens Amp           |       | 120      | Amp            |
| T61-AAVP-1                         | 6" Oval Amber Turn Vertical Surface Mount Amber Len Pig Tail      |       | 140      | Pigtail        |
| T61-AAVT-1                         | 6" Oval Amber Turn Vertical Surface Mount Amber Lens 3 Pole       |       | 120      | Tri Pole       |
| T61-AAZHA-1                        | 6" Oval Amber Strobe Horiz. Surface Mt Amber Lens Amp Connector   |       | 120      | Amp            |
| T61-AAZHP-1                        | 6" Oval Amber Strobe Horiz. Surface Mnt Amber Lens Pig Tail       |       | 140      | Pigtail        |
| T61-AAZHT-1                        | 6" Oval Amber Strobe Horiz. Surface Mnt Amber Lens 3 Pole         |       | 120      | Tri Pole       |
| T61-AAZVA-1                        | 6" Oval Amber Strobe Vertical Surface Mt Amber Lens Amp Connector |       | 120      | Amp            |
| T61-AAZVP-1                        | 6" Oval Amber Strobe Vertical Surface Mnt Amber Lens Pig Tail     |       | 140      | Pigtail        |
| T61-AAZVT-1                        | 6" Oval Amber Strobe Vertical Surface Mnt Amber Lens 3 Pole       |       | 120      | Tri Pole       |
| T61-ACHA-1                         | 6" Oval Amber Turn Horiz. Surface Mount Clear Lens Amp Connector  |       | 120      | Amp            |
| T61-ACHP-1                         | 6" Oval Amber Turn Horiz. Surface Mount Clear Lens Pig Tail       |       | 140      | Pigtail        |
| T61-ACHT-1                         | 6" Oval Amber Turn Horiz. Surface Mount Clear Lens 3 Pole         |       | 120      | Tri Pole       |
| T61-ACVA-1                         | 6" Oval Amber Turn Vert. Surface Mount Clear Lens Amp connector   |       | 120      | Amp            |
| T61-ACVP-1                         | 6" Oval Amber Turn Vertical Surface Mnt Clear Lens Pig Tail       |       | 140      | Pigtail        |
| T61-ACVT-1                         | 6" Oval Amber Turn Vertical Surface Mnt Clear Lens 3 Pole         |   | 120      | Tri Pole       |
| T61-RCHA-1                         | 6" Oval Red STT Horiz. Surface Mount Clear Lens Amp               |   | 120      | Amp            |
| T61-RCHP-1                         | Red STT Horiz. Surface Mount Clear Lens w/Pig-Tail                |   | 140      | Pigtail        |
| T61-RCHT-1                         | 6" Oval Red STT Horiz. Surface Mount Clear Lens 3 Pole            |   | 120      | Tri Pole       |
| T61-RCVA-1                         | 6" Oval Red STT Vertical Surface Mount Clear Lens Amp             |   | 120      | Amp            |
| T61-RCVP-1                         | 6" Oval Red STT Vertical Surface Mount Clear Lens Pig Tail        |   | 140      | Pigtail        |
| T61-RCVT-1                         | 6" Oval Red STT Vertical Surface Mount Clear Lens 3 Pole          |   | 120      | Tri Pole       |
| T61-RRHA-1                         | 6" Oval Red STT Horiz. Surface Mount Red Lens Amp                 |   | 120      | Amp            |
| T61-RRHB-1                         | 6" Oval Red STT Horiz Surf Mnt Red Lns PigTail w/.180 Bullet      |   | 140      | 0.180" Bullets |
| T61-RRHP-1                         | 6" Oval Red STT Horiz. Surface Mount Red Lens w/Pig-Tail          |   | 140      | Pigtail        |
| T61-RRHT-1                         | 6" Oval Red STT Horiz. Surface Mount Red Lens 3 Pole              |   | 120      | Tri Pole       |
| T61-RRVA-1                         | 6" Oval Red STT Vertical Surface Mount Red Lens Amp               |   | 120      | Amp            |
| T61-RRVP-1                         | 6" Oval Red STT Vertical Surface Mount Red Lens Pig Tail          |   | 140      | Pigtail        |
| T61-RRVT-1                         | 6" Oval Red STT Vertical Surface Mount Red Lens 3 Pole            |   | 120      | Tri Pole       |
| T61-WCHP-1                         | 6" Oval Horizontal Surface Mount Light Pigtail                    |   | 140      | Pigtail        |
| T61-WCVP-1                         | 6" Oval Vertical Surface Mount Reverse Light Pigtail              |   | 140      | Pigtail        |
| T61-WCVP-1                         | 6" Oval Vertical Surface Mount Reverse Light Pigtail              |   | 140      | Pigtail        |
| <b>T62 - Flush Mount Oval Tail</b> |   |   |          |                |
| T62-0S00-1                         | SS trim ring for oval tail lamp                                   |   | -        | -              |
| T62-AAHA-1                         | Amber Flush Mount Horizontal Amber Lens Amp Connector             |   | 120      | Amp            |



| Part No.   | Part Description   |   | Std Pack | Connector      |
|--|--|---|----------|----------------|
| T62-AAWA-1                                       | Amber Flush Mount Horizontal White Base Amber Lens Amp             |       | 120      | Amp            |
| T62-RCHA-1                                       | Red Flush Mount Horizontal Oval Tail Clear Lens Amp Connecto       |       | 120      | Amp            |
| T62-RCVA-1                                       | Red Flush Mount Vertical Oval Tail Clear Lens Amp Connector        |       | 120      | Amp            |
| T62-RRHA-1                                       | Red Flush Mount Horizontal Oval Tail Red Lens Amp Connector        |       | 120      | Amp            |
| T62-RRVA-1                                       | Red Flush Mount Vertical Oval Tail Red Lens Amp Connector          |       | 120      | Amp            |
| T62-W0VA-1                                       | Oval Tail Reverse Lamp Flush Vertical Mount                        |       | 120      | Amp            |
| <b>T66 - Universal Mount Oval Stop-Turn-Tail</b> |  |   |          |                |
| T66-AA0A-1                                       | 6" Oval 6 LED Turn Grommet Mount Amber Lens Amp Conn.              |       | 120      | Amp            |
| T66-AA0P-1                                       | 6" Oval 6 LED Turn Grommet Mount Amber Lens Pigtail                |       | 140      | Pigtail        |
| T66-AA0T-1                                       | 6" Oval 6 LED Turn Grommet Mount Amber Lens 3 Pole                 |       | 120      | Tri Pole       |
| T66-AASA-1                                       | Oval 6 LED Turn Surface Mount Amber Lens Amp Conn.                 |       | 120      | Amp            |
| T66-AASP-1                                       | 6" Oval 6 LED Turn Surface Mount Amber Lens Pig-Tail               |       | 140      | Pigtail        |
| T66-AAST-1                                       | 6" Oval 6 LED Turn Surface Mount Amber Lens 3 Pole                 |       | 120      | Tri Pole       |
| T66-AC0A-1                                       | 6" Oval 6 LED Turn Grommet Mount Clear Lens Amp Con                |       | 120      | Amp            |
| T66-AC0P-1                                       | 6" Oval 6 LED Turn Grommet Mount Clear Lens Pigtail                |       | 140      | Pigtail        |
| T66-AC0T-1                                       | 6" Oval 6 LED Ambr Turn Grommet Mount Clear Lens 3 Pole            |       | 120      | Tri Pole       |
| T66-RC0A-1                                       | 6" Oval 6 LED STT Grommet Mount Clear Lens Amp Connector           |       | 120      | Amp            |
| T66-RC0P-1                                       | 6" Oval 6 LED STT Grommet Mount Clear Lens Pigtail                 |       | 140      | Pigtail        |
| T66-RC0T-1                                       | 6" Oval 6 LED STT Grommet Mount Clear Lens 3 Pole                  |       | 120      | Tri Pole       |
| T66-RCSB-1                                       | 6" Oval LED STT Surface Mount Clear Lens with .180 Bullets         |   | 140      | 0.180" Bullets |
| T66-RCSP-1                                       | 6" Oval 6 LED STT Surface Mount Clear Lens Pigtail                 |   | 140      | Pigtail        |
| T66-RCST-1                                       | 6" Oval 6 LED STT Surface Mount ClearLens 3 Pole                   |   | 140      | Tri Pole       |
| T66-RR0A-1                                       | 6" Oval 6 LED STT Grommet Mount Red Lens Amp Connector             |   | 120      | Amp            |
| T66-RR0P-1                                       | 6" Oval 6 LED STT Grommet Mount Red Lens Pigtail                   |   | 140      | Pigtail        |
| T66-RR0T-1                                       | 6" Oval 6 LED STT Grommet Mount Red Lens 3 Pole                    |   | 120      | Tri Pole       |
| T66-RRSA-1                                       | 6" Oval 6 LED STT Surface Mount Red Lens Amp Conn.                 |   | 120      | Amp            |
| T66-RRSB-1                                       | 6" Oval 6 LED STT Surface Mount Red Lens w/180 Bullets             |   | 140      | 0.180" Bullets |
| T66-RRSP-1                                       | 6" Oval 6 LED STT Surface Mount Red Lens Pigtail                   |   | 140      | Pigtail        |
| T66-RRST-1                                       | 6" Oval 6 LED STT Surface Mount Red Lens 3 Pole                    |   | 120      | Tri Pole       |
| T66-WC0T-1                                       | 6" Oval 6 LED White Grommet Mount Clear Lens 3 Pole                |   | 120      | Tri Pole       |
| T66-WCRA-1                                       | 6" Oval Reverse 6 LED White Grommet Mount Clear Lens Amp           |   | 120      | Amp            |
| T66-WCRB-1                                       | 6" Oval Reverse 6 LED White Grommet Clear Crimped 180 bul          |   | 140      | 0.180" Bullets |
| T66-WCRP-1                                       | 6" Oval Reverse 6 LED White Grommet Mount Clear Lens PigTail       |   | 140      | Pigtail        |
| T66-WCRT-1                                       | 6" Oval Reverse 6 LED White Grommet Mount Clear Lens 3 Pole        |   | 120      | Tri Pole       |
| T66-WCSA-1                                       | 6" Oval 6 LED White Reverse Surface Mount Clear Lens Amp Connector |   | 120      | Amp            |
| T66-WCSP-1                                       | 6" Oval 6 LED White Reverse Surface Mount Pig-Tail                 |   | 140      | Pigtail        |
| T66-WCST-1                                       | 6" Oval 6 LED White Reverse Surface Mount Clear Lens 3 Pole        |   | 120      | Tri Pole       |
| <b>T67 - 6" Oval LED Stop/Tail/Turn</b>          |  |   |          |                |
| T67-AWZ0A-1                                      | 6" Oval Grommet, Amber Flasher Diffuse Reverse t w AMP             |   | TBD      | Amp            |

| Part No.  | Part Description  |   | Std Pack | Connector |
|---|---|---|----------|-----------|
| T67-RC0A-1  | 6" Oval Grommet, RED stop Diffuse Tail w AMP                        |    | TBD      | Amp       |
| T67-RW0A-1  | 6" Oval Grommet Red Diffuse STTR w Dual Amp                         |    | TBD      | Amp       |
| T67-WC0A-1  | 6" Oval Grommet Diffuse Reverse w Amp                               |    | TBD      | Amp       |
| <b>T68 - 6" Oval High Visibility LED Stop/Tail/Turn</b> |   |   |          |           |
| T68-AAG0A-1   | 6" Oval High Viz Amber Lens Grommet Mount w Amp Conn                |    | 120      | Amp       |
| T68-AAG0P-1   | 6" Oval High Viz Amber Lens Grommet Mount w Pigtail                 |    | 140      | Pigtail   |
| T68-AAG0T-1   | 6" Oval High Viz Amber Lens Grommet Mount w Tripole Connector       |    | 120      | Tri Pole  |
| T68-AAZ0A-1   | 6" oval high visibility Strobe grommet mount with amp connector     |    | 120      | Amp       |
| T68-AAZ0P-1   | 6" oval high visibility Strobe grommet mount with pigtail wires     |    | 140      | Pigtail   |
| T68-AAZ0T-1   | 6" oval high visibility Strobe grommet mount                        |    | 120      | Tri Pole  |
| T68-ACG0A-1   | 6" Oval High Visibility Clear Lens Grommet Mount S                  |    | 120      | Amp       |
| T68-ACG0P-1   | 6" Oval High Visibility Clear Lens Grommet Mount S                  |    | 140      | Pigtail   |
| T68-ACG0T-1   | 6" Oval High Visibility Clear Lens Grommet Mount S                  |    | 120      | Tri Pole  |
| T68-RCG0T-1   | 6" Oval High Visibility Grommet Mount Clear Lens STT Tripole        |    | 120      | Tri Pole  |
| T68-RRF0A-1   | 6" Oval High Visibility Flange Mount STT Amp Conn.                  |    | 120      | Amp       |
| T68-RRF0P-1   | 6" Oval High Visibility Flange Mount STT Pig-Tail                   |    | 140      | Pigtail   |
| T68-RRF0T-1   | 6" Oval High Visibility Flange Mount STT Tripole Connector          |    | 120      | Tri Pole  |
| T68-RRG0A-1   | 6" Oval High Visibility Grommet Mount STT Amp Conn                  |    | 120      | Amp       |
| T68-RRG0P-1   | 6" Oval High Visibility Grommet Mount STT Pig-Tail                  |    | 140      | Pigtail   |
| T68-RRG0T-1   | 6" Oval High Visibility Grommet Mount STT Tripole Connector         |    | 120      | Tri Pole  |
| T68-RRS0A-1   | 6" Oval High Visibility Surface Mount STT Amp Conn                  |   | 120      | Amp       |
| T68-RRS0P-1   | 6" Oval High Visibility Surface Mount STT Pig-Tail                  |  | 140      | Pigtail   |
| T68-RRS0T-1   | 6" Oval High Visibility Surface Mount STT Tripole Connector         |  | 120      | Tri Pole  |
| T68-RRSPA-1   | 6" Oval High Visibility Surface Mount STT 9in Wires w Amp Connector |  | 120      | Amp       |
| T68-RTG0P-1   | T68 Red STT Grommet Mount Tinted Lens with Pigtails                 |  | 140      | Pigtail   |
| T68-WCF0A-1   | 6" Oval High Vis Reverse Clear Lens Flange Mount Amp Connector      |  | 120      | Amp       |
| T68-WCF0P-1   | 6" Oval High Vis Reverse Clear Lens Flange Mount Pigtail Connector  |  | 140      | Pigtail   |
| T68-WCF0T-1   | 6" Oval High Vis Reverse Clear Lens Flange Mount Tripole Connector  |  | 120      | Tri Pole  |
| T68-WCG0A-1   | 6" Oval High Vis Reverse Clear Lens Grommet Mount Amp Connector     |  | 120      | Amp       |
| T68-WCG0P-1   | 6" Oval High Vis Reverse Clear Lens Grommet Mount Pigtail Connector |  | 140      | Pigtail   |
| T68-WCG0T-1   | 6" Oval High Vis Reverse Clear Lens Grommet Mount Tripole Connector |  | 120      | Tri Pole  |
| <b>T70 - Combination Oval Stop-Turn-Tail-Reverse</b>    |   |   |          |           |
| T70-RC0A-1  | Oval Grommet Stop Tail Reverse Clear 2 Amp Connectors               |  | 100      | Amp       |
| T70-RC0P-1  | Oval Grommet Stop Tail Reverse Clear 2 Pigtail Wire                 |  | 120      | Pigtail   |
| T70-RC0T-1  | Oval Grommet Stop Tail Reverse Clear 2 Tri Pole Connectors          |  | 100      | Tri Pole  |
| T70-RCFA-1  | Oval Flange Stop Tail Reverse Clear 2 Amp Connectors                |  | 120      | Amp       |
| T70-RCFP-1  | Oval Flange Stop Tail Reverse Clear 2 Pigtail Wire                  |  | 140      | Pigtail   |
| T70-RCSA-1  | Oval Surface Stop Tail Reverse Clear 2 Amp Connectors               |  | 120      | Amp       |
| T70-RCSP-1  | Oval Surface Stop Tail Reverse Clear 2 Pigtail Wire                 |  | 140      | Pigtail   |

| Part No.                                       | Part Description   |   | Std Pack | Connector                    |
|--|--|---|----------|------------------------------|
| T70-RCST-1                                     | Oval Surface Stop Tail Reverse Clear 2 Tri Pole Connectors                 |    | 120      | Tri Pole                     |
| T70-RW0A-1                                     | Oval Grommet Stop Tail Reverse 2 Amp Connectors                            |    | 100      | Amp                          |
| T70-RW0P-1                                     | Oval Grommet Stop Tail Reverse 2 Pigtail Wire                              |    | 120      | Pigtail                      |
| T70-RW0T-1                                     | Oval Grommet Stop Tail Reverse 2 Tri Pole Connectors                       |    | 100      | Tri Pole                     |
| T70-RWFA-1                                     | Oval Flange Stop Tail Reverse 2 Amp Connectors                             |    | 100      | Amp                          |
| T70-RWFP-1                                     | Oval Flange Stop Tail Reverse 2 Pigtail Wire                               |    | 140      | Pigtail                      |
| T70-RWSA-1                                     | Oval Surface Stop Tail Reverse 2 Amp Connectors                            |    | 120      | Amp                          |
| T70-RWSB-1                                     | Oval Surface Stop Tail Reverse W/.180 Bullets                              |    | 140      | 0.180" Bullets               |
| T70-RWSP-1                                     | Oval Surface Stop Tail Reverse 2 Pigtail Wire                              |    | 140      | Pigtail                      |
| T70-RWSPA-1                                    | Oval Surface Stop Tail Reverse 2 Pigtail Wire w Amp Connector              |    | 120      | Amp                          |
| T70-RWST-1                                     | Oval Surface Stop Tail Reverse 2 Tri Pole Connectors                       |    | 120      | Tri Pole                     |
| <b>T71 - 4" Rectangular LED Stop/Tail/Turn</b> |  |   |          |                              |
| T71-0G00-1                                     | T71 Grommet  |   | -        | -                            |
| T71-AA0A-1                                     | Rectangular 8 LED Turn Dual Intensity Grommet Mount Amber Lens Amp Con     |    | 24       | Amp                          |
| T71-AA0P-1                                     | 4" Rectangular Amber Lens Amber LED AMP Connector W/Pigtails & Grommet     |    | 24       | Pigtail                      |
| T71-AA0T-1                                     | 4" Rectangular Amber Lens Amber LED Tripole Connector& Grommet             |    | 24       | Tri Pole                     |
| T71-AAZA-1                                     | 4" Rectangular Class 1 Amber AutoSync Flasher                              |    | 24       | Amp                          |
| T71-AAZP-1                                     | 4" Rectangular Class 1 Amber AutoSync Flasher w/Pigtails                   |    | 24       | Pigtail                      |
| T71-AC0A-1                                     | Rectangular 8 LED Turn Dual Intensity Grommet Mount Clear Lens Amp Con     |   | 24       | Amp                          |
| T71-AC0P-1                                     | Rectangular 8 LED Turn Dual Intensity Grommet Mount Clear Lens Pigtail     |  | 24       | Tri Pole                     |
| T71-AC0T-1                                     | Rectangular 8 LED Turn Dual Intensity Grommet Mount Clear Lens T style     |  | 24       | Tri Pole                     |
| T71-RC0A-1                                     | 4" Rectangular Clear Lens Red LED Amp Conn. & Gromet                       |  | 24       | Amp                          |
| T71-RC0P-1                                     | 4" Rectangular Clear Lens Red LED W/Pigtails & Grommet                     |  | 24       | Pigtail                      |
| T71-RC0T-1                                     | 4" Rectangular Clear Lens Red LED Tripole Connector& Grommet               |  | 24       | Tri Pole                     |
| T71-RR0A-1                                     | 4" Rectangular Red Lens Red LED AMP Connector & Grommet                    |  | 24       | Amp                          |
| T71-RR0P-1                                     | 4" Rectangular Red Lens Red LED W/Pigtails & Grommet                       |  | 24       | Pigtail                      |
| T71-RR0T-1                                     | 4" Rectangular Red Lens Red LED Tripole Connector& Grommet                 |  | 24       | Tri Pole                     |
| T71-WCRA-1                                     | Rectangular 8 LED Reverse White Grommet Mount Clear Lens Amp Connector     |  | 24       | Amp                          |
| T71-WCRP-1                                     | 4" Rectangular Clear Lens White LED Pigtail                                |  | 24       | Pigtail                      |
| T71-WCRT-1                                     | 4" Rectangular Clear Lens White LED Tripole Connector & Grommet            |  | 24       | Tri Pole                     |
| <b>T80 - 8" Multifunction Box Tail Light</b>   |  |   |          |                              |
| T80-RRLG-1                                     | 8 Function 8" Box Tail Light L-Side Pig Tail 1/4" GND Ring                 |  | 32       | Pigtail / Self grounded      |
| T80-RRLGC-1                                    | 8 Function 8" Box Tail Light L-Side w Gnd Ring and 2-Pole Conn Bullet Tail |  | 32       | 2-Pole / Self Grounded       |
| T80-RRLP-1                                     | 8 Function 8" Box Tail Light Left Side Pig Tail                            |  | 32       | Pigtail                      |
| T80-RRRG-1                                     | 7 Function 8" Box Tail Light R-Side Pig Tail 1/4" GND Ring                 |  | 32       | Pigtail / Self grounded      |
| T80-RRRGC-1                                    | 7 Function 8" Box Tail Light R-Side w Gnd Ring and 2-Pole Conn Bullet Tail |  | 32       | 2-Pole / Self Grounded       |
| T80-RRRP-1                                     | 7 Function 8" Box Tail Light Right Side Pig Tail                           |  | 32       | Pigtail                      |
| <b>T85 - 4" Multifunction Box Tail Light</b>   |  |   |          |                              |
| T85-RRLB-1                                     | 8 Function 4" Box Tail Light Left Side Pig Tail W/                         |  | 32       | Pigtail w/<br>0.180" Bullets |

| Part No.  | Part Description  |   | Std Pack | Connector                    |
|---|---|---|----------|------------------------------|
| T85-RRLG-1  | 8 Function 4" Box Tail Light Left Pig Tail 1/4" GND Ring                |       | 32       | Pigtail / Self grounded      |
| T85-RRLP-1  | 8 Function 4" Box Tail Light Left Side Pig Tail                         |       | 32       | Pigtail                      |
| T85-RRRB-1  | 7 Function 4" Box Tail Light Right Side Pig Tail W                      |       | 32       | Pigtail w/<br>0.180" Bullets |
| T85-RRRG-1  | 7 Function 4" Box Tail Light Right Pig Tail 1/4" GND Ring               |       | 32       | Pigtail / Self grounded      |
| T85-RRRP-1  | 7 Function 4" Box Tail Light Right Side Pig Tail                        |       | 32       | Pigtail                      |
| <b>T86 - 6" Multifunction Box Tail Light</b>      |   |   |          |                              |
| T86-RR2LG-1                                       | 8 Function 6" Box Slim Line Tail Light Left Side Pig Tail W/Ground Ring |       | 32       | Pigtail / Self grounded      |
| T86-RR2LP-1                                       | 8 Function 6" Box Slim Line Tail Light Left Side Pig Tail               |       | 32       | Pigtail                      |
| T86-RR2LS-1                                       | 8 Function 6" Box Slim Line Tail Light Left Side P                      |       | 32       | 2-Pole / Self Grounded       |
| T86-RR2RG-1                                       | 7 Function 6" Box Slim Line Tail Light Right Side                       |       | 32       | Pigtail / Self grounded      |
| T86-RR2RP-1                                       | 7 Function 6" Box Slim Line Tail Light Right Side                       |       | 32       | Pigtail                      |
| T86-RR2RS-1                                       | 7 Function 6" Box Slim Line Tail Light Right Side                       |       | 32       | 2-Pole / Self Grounded       |
| <b>T88 - 8" TecLoq - Eight Function Box Light</b> |   |   |          |                              |
| T88-RRLT-1  | 8 Function Slim Line Snap Mount Tail Light Left Si                      |       | TBD      | Tri Pole                     |
| T88-RRRT-1  | 7 Function Slim Line Snap Mount Tail Light Right S                      |       | TBD      | Tri Pole                     |
| <b>T89 - 4" TecLoq - Eight Function Box Light</b> |   |   |          |                              |
| T89-RRLP-1  | 8 Function 4" Box Tail Light Snap Mount Left Pigta                      |       | TBD      | Pigtail                      |
| T89-RRRP-1  | 7 Function 4" Box Tail Light Snap Mount Right Pig                       |       | TBD      | Pigtail                      |
| <b>T90 - Mid-Ship Turn Signal/Side Marker</b>     |   |   |          |                              |
| T90-AAFA-1  | Midturn Amber Lens Flange Mount Amp                                     |   | 112      | Amp                          |
| T90-AAFP-1  | Midturn Amber Lens Flange Mount Pigtail                                 |   | 112      | Pigtail                      |
| T90-AAFT-1  | Midturn Amber Lens Flange Mount Tripole                                 |   | 112      | Tri Pole                     |
| T90-AAGA-1  | Midturn Amber Lens Grommet Mount Amp                                    |   | 80       | Amp                          |
| T90-AAGP-1  | Midturn Amber Lens Grommet Mount Pigtail                                |   | 80       | Pigtail                      |
| T90-AAGT-1  | Midturn Amber Lens Grommet Mount Tripole                                |   | 80       | Tri Pole                     |
| T90-AASA-1  | Midturn Amber Lens Surface Mount Amp                                    |   | 80       | Amp                          |
| T90-AASP-1  | Midturn Amber Lens Surface Mount Pigtail                                |   | 80       | Pigtail                      |
| T90-AAST-1  | Midturn Amber Lens Surface Mount Tripole                                |   | 80       | Tri Pole                     |
| T90-ACFA-1  | Midturn Clear Lens Flange Mount Amp                                     |   | 112      | Amp                          |
| T90-ACFP-1  | Midturn Clear Lens Flange Mount Pigtail                                 |   | 112      | Pigtail                      |
| T90-ACFT-1  | Midturn Clear Lens Flange Mount Tripole                                 |   | 112      | Tri Pole                     |
| T90-ACGA-1  | Midturn Clear Lens Grommet Mount Amp                                    |   | 80       | Amp                          |
| T90-ACGP-1  | Midturn Clear Lens Grommet Mount Pigtail                                |   | 80       | Pigtail                      |
| T90-ACGT-1  | Midturn Clear Lens Grommet Mount Tripole                                |   | 80       | Tri Pole                     |
| T90-ACSA-1  | Midturn Clear Lens Surface Mount Amp                                    |   | 80       | Amp                          |
| T90-ACSP-1  | Midturn Clear Lens Surface Mount Pigtail                                |   | 80       | Pigtail                      |
| T90-ACST-1  | Midturn Clear Lens Surface Mount Tripole                                |   | 80       | Tri Pole                     |
| T90-ATGP-1  | Midturn P2 Tinted Lens Grommet Mount Pigtail                            |   | 80       | Pigtail                      |
| T90-ATSP-1  | Midturn Tinted Lens Surface Mount Pigtail                               |   | 80       | Pigtail                      |



| Part No.                      | Part Description   | Std Pack | Connector      |
|-------------------------------|--|----------|----------------|
| <b>Wires &amp; Connectors</b> |  |          |                |
| S99-0010-1                    |  | -        | Male 2 Pole    |
| S99-0035-1                    | S35 2-Pole Sure-Seal w/.180" Bullet and #6 GND Lug 90 deg. | -        | Two Pole       |
| S99-0A35-1                    | S35 2-Pole Sure-Seal w/.180" Bullet and 1" #10 GND Lug     | -        | Two Pole       |
| S99-3600-1                    | 2 Pole Connector W/Bullet Ends                             | -        | Two Pole       |
| S99-3610-1                    | 2 Pole Connector W/Bullet Ends and Grommet                 | -        | Two Pole       |
| T99-0010-1                    | 12" 3-Pole .156" Bullet w/#6 GND Lug - Straight            | -        | Tri Pole       |
| T99-0020-1                    | 12" 3-Pole .156" Bullet w/#6 GND Lug - 90 degree           | -        | Tri Pole       |
| T99-0040-1                    | Amp - Pigtail Wire Adapter                                 | -        | Amp            |
| T99-0050-1                    | Amp - Tripole Adapter                                      | -        | Amp - Tri Pole |
| T99-0060-1                    | Y Style plug with 6" wires                                 | -        | Tri Pole       |
| T99-0090-1                    | 20ft 4 pole Wire Harness                                   | -        | 4-Pin          |
| T99-0091-1                    | 25ft 4 pole Wire Harness                                   | -        | 4-Pin          |
| T99-0092-1                    | 30' 4-Pole Wire Harness                                    | -        | 4-Pin          |
| T99-0093-1                    | 35' 4-Pole Wire Harness                                    | -        | 4-Pin          |

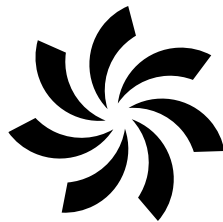

**TecNiq Inc.**

sales@tecniqinc.com

269-629-4440

**TecNiqInc.com**

TecNiq manufactures the highest quality, most technologically advanced LED lighting solutions in the industry. We believe that brighter, longer lasting LED products help keep our customers safe, and we stand behind every light we make with a Lifetime Limited Warranty.



TecNiq lights are produced with **TecSeal**, our proprietary polyurethane potting material. TecSeal is developed to last longer and can withstand more extreme weather than competitors lights.



TecNiq is your premier **OEM Supplier** for LED lighting solutions. We take pride each and every day in our commitment to supporting the manufacturers that rely on us for their lighting needs. With technical support, account, and delivery information readily available, it's easy to see why so many companies are choosing TecNiq.



TecNiq is proud to offer a **No Hagggle, Lifetime Limited Warranty** on all of our LED products. Take the worry out of your OEM experiences, and have piece of mind that TecNiq lights will light up time and time again, or we will replace them.