

# VESSEL®

Screwdrivers & Bits Since 1916



JAPAN  
ORIGIN

JIS DRIVE+

VESSEL Co., Inc.  
Osaka Japan  
[www.vessel.co.jp/english/](http://www.vessel.co.jp/english/)

VESSEL TOOLS U.S.A., INC.  
[vesseltoolsusa.com/](http://vesseltoolsusa.com/)

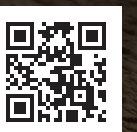

# VESSEL ism



Do not follow the crowd



Constantly adapt to changes



Make no compromise on quality



Value created with customers

## CERTIFICATIONS



# HISTORY 1916-2023



1916 VESSEL® trademark is registered. The company's name represents its aim to deliver international markets



1933 First Hand Screwdriver catalogue

1952 Authorized to display JIS (Japanese Industrial Standards) mark on Screwdrivers



1958 Launch of the first air screwdriver



1962 Foundation of VESSEL® Co. Inc.



1974 Launch of CRYSTALLINE screwdrivers



1981 Win at the Macau Grand Prix



1987 Announcement of the client management system «Q-System»



1999 Launch of the gasoline engine impact wrench



2005 Opening of the french subsidiary and European VESSEL® headquarter



2014 Electric screwdrivers and «power scaler» which drastically improves iron work and shipbuilding



2019 Launch of the USB screwdriver series

1916 1933 1948 1952 1954 1958 1961 1962 1972 1974 1981 1984 1987 1997 1999 2000 2005 2007 2014 2016 2019 2023

1916 Ginosuke Taguchi establishes the Hand Screwdriver manufacturing company in Osaka, Japan



1948 Creation of Nihon Nejimawashi Co.Ltd (transl.: Japan screwdriver)

1954 Begin of manufacturing industrial tools

1961 Invention of the double ended bits



1972 Sunline and Tigerline sets



1974 Launch of Air Nippers



1984 First Ball Grip screwdrivers



1997 The flagship screwdrivers MEGADORA are launched



2000 Anti-static solution product



2007 STAT CLEAN Conductive rubber mat

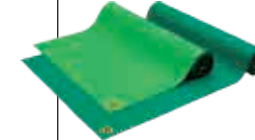

2016 100 Years VESSEL®

**100<sup>th</sup>**  
VESSEL 1916-2016

Starting of VESSEL TOOLS U.S.A., Inc. in California in 2016



# VESSEL HAND TOOLS / SCREWDRIVERS

## VESSEL® SHANK TYPES



**Bolt shank**, diameter of 8 mm or less  
With hexagonal bolster for spanner

**Standard shank**  
Popular shank diameter and length based on various standards

**Thin shank**, diameter of 4 mm  
Long slender shank to avoid interference even in a narrow area

**Long shank**  
Suitable for screw tightening in deep area

**Stubby shank**  
Short shank suitable for work in a confined area

# JIS DRIVE+



**General type**  
Type in which a shank is held in the handle.

**Tang-Thru type**  
A shank is installed through the handle so that the screwdriver can be used for position adjustment or screw-hole correction by tapping the head with a hammer.

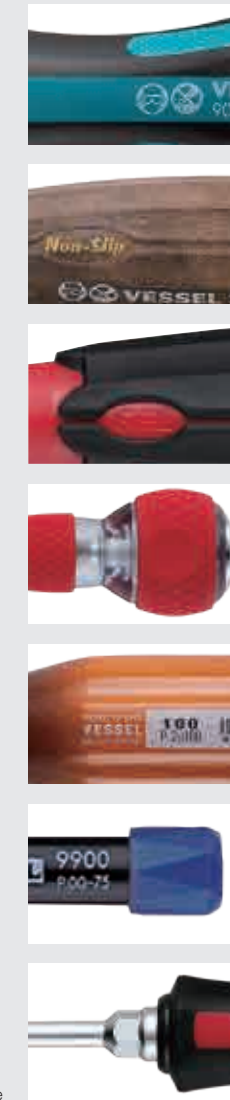

**Ergonomic design**  
The use of design taking into account the shape of the palm ensures comfortable screw tightening.

**Non-slip**  
VESSEL®-developed non-slip surface for the WOOD COMPO range enables torque transmission and screwing even with oily hands.

**Cushion handle**  
Elastic elastomer grip, offering large tightening force.

**Ball Grip**  
Transmits ample tightening force to screw with a comfortable grip fitting to the palm.

**Wood handle**  
Made of natural wood in the tradition of more than a hundred years.

**Precision**  
Designed to transmit a minute force efficiently. Intended for precision work.

**Hexagon bolster**  
This part allows a spanner, etc. to be applied to retighten a screw or undo a hard-tightened screw.



Magnetic

**Magnetized tip end**  
Allows to capture screws for better work efficiency.



**Precision and durability**  
Thanks to high quality materials: Cr (chromium), V (vanadium), Mo (molybdenum)

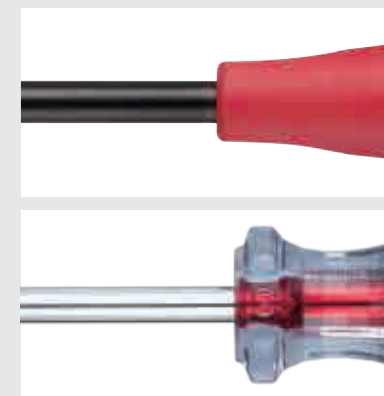

**Taper shape**  
Enabling a screwdriver to be easily taken out of a holder.

**Rolling prevention**  
Avoiding rolling-over, for more security at work

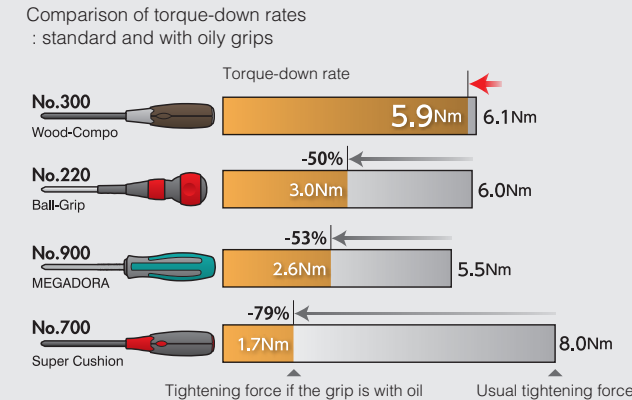

## BENEFITS of "MEGADORA"

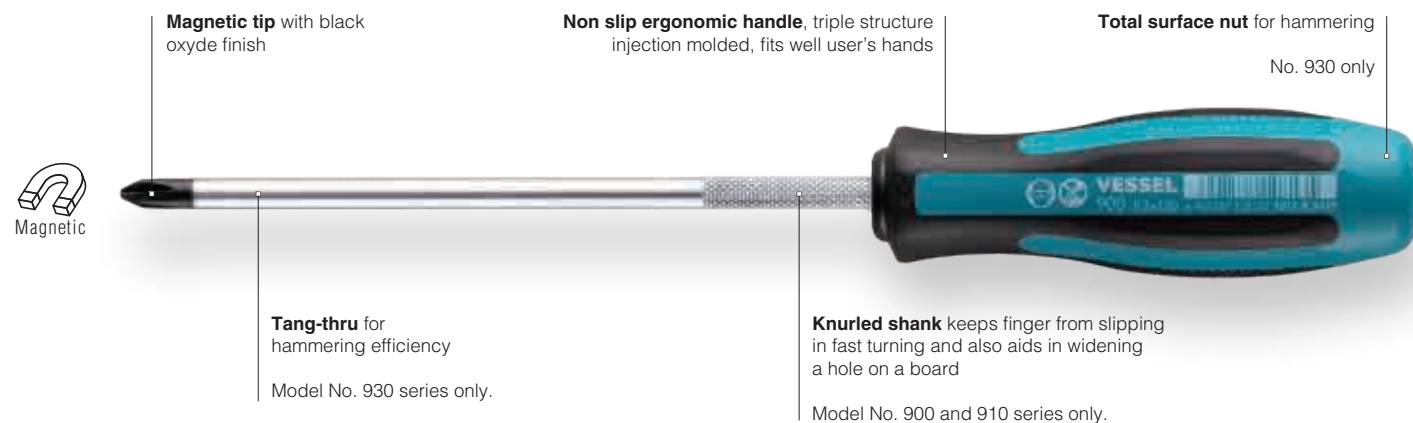

**Magnetic tip** with black oxyde finish

**Non slip ergonomic handle**, triple structure injection molded, fits well user's hands

**Total surface nut** for hammering  
No. 930 only

**Tang-thru** for hammering efficiency  
Model No. 930 series only.

**Knurled shank** keeps finger from slipping in fast turning and also aids in widening a hole on a board  
Model No. 900 and 910 series only.

## JAWSFIT®

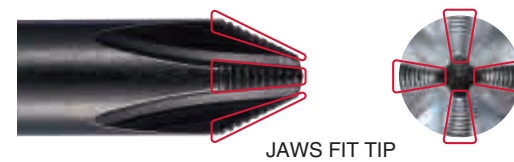

**JAWSFIT®** technology for better compatibility with the screws. Small projections on the blades, enabling the screwdriver to bite finny into a cross-section of the screw and avoiding cam-out.



**IMPACTA**  
For removing stuck, rusted and distorted screws. Our Tang-thru nut incorporates a cam rotation mechanism which turns the driving tip counter-clockwise by 12° when the handle is hit with a hammer. The IMPACTA system leverages impact acceleration to remove stuck screws.

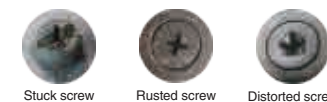

# What's new, BALL GRIP™ USB Series

## Electric X Manual

Electric-powered quick tightening!!  
Manual final tightening!!

Product Video



Make your work more efficiently.  
Easy to use.



USB charging

**Charging port**

Easy charging with USB port

Micro USB type B



High-brightness  
**LED**

**LED light**

High-brightness LED light that can be used even in dark places.



Off-delay function that glows for 5 seconds after use.

VESSEL can offer wide ranges of bits and bit sets for 220USB.



See page 23 for more details.

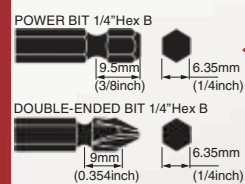

Replacement of the screwdriver bit.

### BALL GRIP™ Rechargeable Screwdriver with 25 PC. Bit Set

- Electric output 17.7lbf-in(2.0N·m), No-load speed 280rpm, Manual torque up to 88.5lbf-in(10.N·m)
- With 24pc of bits and 1pc of bit holder.
- Electric power for quick tightening and Manual for final tightening.
- With High Brightness LED light.
- Built in USB Recharge Li-ion Battery (3.6V-800mAh).
- 6.35mm HEX shank.



Package



**Contents**

- 220USB-1U(Higher Torque model) x 1pc
- Impact Ball Torsion Bit (30mm) x 24pc
- Impact Ball Bit holder x 1pc
- USB Charging Cable (Micro USB Type B) (1m) x 1pc

<b>Electric Output</b> 17.7 lbf-in	<b>No-load Speed</b> 280 rpm	<b>Manual Torque</b> Up to 88.5 lbf-in
---------------------------------------	---------------------------------	---

Model No.	Bit (mm)	Bit (mm)	Package size (mm)	Code
220USB25U	30*1/67*2	140*3	184x123x67	148527

\*1 Bit only \*2 Bit Holder only \*3 Tool only

**INCLUDES** Impact Ball™ Torsion Bit \* BitSize: 1-3/16"(30mm)

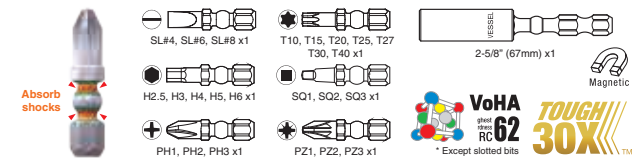

### BALL GRIP™ Rechargeable Screwdriver <Higher Torque Model>

- Electric output 17.7lbf-in (2.0N·m), No-load speed 280rpm, Manual torque up to 88.5lbf-in (10.N·m)
- Electric power for quick tightening and Manual for final tightening.
- With High Brightness LED light.
- Built in USB Recharge Li-ion Battery (3.6V-800mAh).
- 6.35mm HEX shank.



Package



- Contents**
- 220USB-1U x 1pc
  - Impact Ball Torsion Bit (PH2 x 90mm) x 1pc
  - USB Charging Cable (Micro USB Type B) (1m) x 1pc

<b>Electric Output</b> 17.7 lbf-in	<b>No-load Speed</b> 280 rpm	<b>Manual Torque</b> Up to 88.5 lbf-in
---------------------------------------	---------------------------------	---

Model No.	Bit (mm)	Bit (mm)	Bit (mm)	Code
220USB1U	PH2	90*1	43	148514

\*1 Bit \*2 Tool Only

### BALL GRIP™ Rechargeable Screwdriver <Higher Speed model>

- Electric output 3.5lbf-in (0.4N·m), No-load speed 1200rpm, Manual torque up to 88.5lbf-in (10.N·m)
- Electric power for quick tightening and Manual for final tightening.
- With High Brightness LED light.
- Built in USB Recharge Li-ion Battery (3.6V-800mAh).
- 6.35mm HEX shank.



Package



- Contents**
- 220USBS-1U x 1pc
  - Impact Ball Torsion Bit (PH2 x 90mm) x 1pc
  - USB Charging Cable (Micro USB Type B) (1m) x 1pc

<b>Electric Output</b> 3.5 lbf-in	<b>No-load Speed</b> 1200 rpm	<b>Manual Torque</b> Up to 88.5 lbf-in
--------------------------------------	----------------------------------	---

Model No.	Bit (mm)	Bit (mm)	Bit (mm)	Code
220USBS1U	PH2	90*1	43	148515

\*1 Bit \*2 Tool Only

MEGADORA SCREWDRIVER

BALL GRIP SCREWDRIVER

SUPER CUSHION SCREWDRIVER

WOOD COMPO SERIES

FOR ELECTRONICS TOOLS/ USEFUL TOOLS

DRIVER SET SERIES

OTHER HAND TOOLS

L-WRENCH

IMPACT BALL

NECK-TORSION

DRYWALLER/ QB

INSERT BITS

POWER BITS

POWER BITS/ MAG CATCHER

DOUBLE-ENDED POWER BITS

NUT SETTERS

Bit Holder

PRECISION BITS





### BALL GRIP™ Tethered Screwdriver



- 5" (125mm)-long blade that can reach deep in distribution boards
- Easy picking from a working waist bag Turning sleeve for smooth operation
- Connection wire to attach Slim Lanyard Cord (No.SC-90)
- High precision black point tip



Model No.	Bit Size	Length (mm)	Code
210S6125	6x125	6.0(1/4")	225 125577
210P2125	2x125	PH2	225 125576

### Anti-drop Slim Cord

- Cord to tether screwdrivers from dropping
- Tangle-free sleeve to prevent from being caught and stuck



Model No.	Mounted load	Length	Code
SC90	500g or less	482 (maximum length 1500) mm	125405

### "NEON" Screwdriver

- Glow-in-the-dark type.
- High precision black point tip.



Model No.	Bit Size	Length (mm)	Code
265S6100	6x100	6.0(1/4")	185 125561
265S6150	6x150	6.0(1/4")	235 125562
265P2100	2x100	PH2	185 125563
265P2150	2x150	PH2	235 125564

### BALL GRIP™ Interchangeable Screwdriver



- Slotted tip used for quick connection terminal such as outlet and frequently-used +2 are combined into one bit.



Model No. / Code	Set Contents
220W62	BALL GRIP™ Interchangeable Drive Handle
233071	⊖6/⊕2 x110 Carded

### BALL GRIP™ Interchangeable Screwdriver Set



- Convenient set with +1, +3, slotted tip used for quick connection terminal such as outlet, frequently-used +2, and Pz2 and Pz3 widely used for European furniture, appliances, sports equipments, and more



Model No. / Code	Set Contents
220W3	BALL GRIP™ Interchangeable Drive Handle
233072	⊕1/⊕3 x110, ⊖6/⊕2 x110 Carded
	PZ2/PZ3 x110

### Combi Plus Screwdriver



- Three sizes are combined into one bit. Can be used for most of Phillips screws commonly used.



Model No. / Code	Set Contents
220W123	BALL GRIP™ Interchangeable Drive Handle
233073	⊕1•⊕3/⊕2 x110 Carded

# GEL GRIP Screwdrivers

## GEL FUNCTION

GEL GRIP is ideal for a heavy load on the palm, such as working for long wood screws.



### SUPER CUSHION™ Screwdriver



- "Super Cushion" grip fits your hand perfectly
- Anti-corrosion black chrome plated blade



Model No.	Bit Size	Length (mm)	Code
700S5575	5.5x75	5.5(3/16")	29 182 125211
700S6100	6x100	6.0(1/4")	32 215 125212
700S6150	6x150	6.0(1/4")	32 265 125213
700S8150	8x150	8.0(5/16")	34 275 125214
700P175	1x75	PH1	29 182 125215
700P2100	2x100	PH2	32 215 125216
700P2150	2x150	PH2	32 265 125217
700P3150	3x150	PH3	34 275 125218

### Cushion Grip Stubby Screwdriver



- Anti-corrosion black chrome plated blade
- Ideal for working in a narrow place



Model No.	Bit Size	Length (mm)	Code
720S615	6x15	6.0(1/4")	35 68 125221
720P115	1x15	PH1	35 68 125222
720P215	2x15	PH2	35 68 125223

\*Bulk

### SUPER CUSHION™ Tang-Thru Screwdriver



- "Super Cushion" grip fits your hand perfectly
- Star-shaped steel cap for hammering
- Anti-corrosion black chrome plated blade



Model No.	Bit Size	Length (mm)	Code
730S5575	5.5x75	5.5(3/16")	29 182 125231
730S6100	6x100	6.0(1/4")	32 215 125232
730S6150	6x150	6.0(1/4")	32 265 125233
730S8150	8x150	8.0(5/16")	34 276 125234
730P175	1x75	PH1	29 182 125235
730P2100	2x100	PH2	32 215 125236
730P2150	2x150	PH2	32 265 125237
730P3150	3x150	PH3	34 276 125238

### Cushion Grip TORX Screwdriver

- Optimal for fastening screws in precision fields.
- Non-electrolytic plating, keeping the precise tip quality.
- Cushion grip fitting comfortably in a hand.
- Also good for tamper-proof TORX screws (except T5 and T6).



Model No.	Bit Size	Length (mm)	Code
640T540	T5	1.42	40(1 37/64") 20.5 126 123561
640T640	T6	1.69	40(1 37/64") 20.5 126 123562
640T7H40	T7H	1.97	40(1 37/64") 20.5 126 123563
640T8H40	T8H	2.30	40(1 37/64") 20.5 126 123564
640T9H40	T9H	2.48	40(1 37/64") 20.5 126 123565

TORX® is a registered trademark of Acument™ Intellectual Properties, LLC (USA). VESSEL has a manufacturing license in Japan and selling same to the world.

### Cushion Grip Interchangeable Stubby Screwdriver

- Stubby type suited for working in cramped places.
- Slotted tip used for quick connection terminal such as outlet and frequently-used ⊕2 are combined into one bit.



Model No. / Code	Set Contents
270BW62	Bit Interchangeable Cushion Stubby Grip
233075	⊖6/⊕2 x110mm Carded

### Cushion Grip Interchangeable Stubby Screwdriver

- Stubby type suited for working in cramped places.
- Three sizes are combined into one bit. Can be used for most of Phillips screws commonly used.



Model No. / Code	Set Contents
270BW123	Bit Interchangeable Cushion Stubby Grip
233076	⊕1•⊕3/⊕2 x45mm Carded

# WOOD-COMPO™ Ratchet SETS

## NON-SLIP with Oil or Grease

You lose only 3% of torque even with oily or greasy hands. WOOD COMPO improves your performance such as working for car maintenance and ironwork.



## WOOD-COMPO™ Swivel Socket Wrench Set

1/4"sq. (6.35mm) 21pcs.



Model No. / Code	Set Contents
HRW2004MSW	Wood-compo swivel ratchet handle 1/4"sq. (6.35mm)
162102	Extension bar Overall length 55mm 1/4"sq. (6.35mm)
	Extension bar Overall length 150mm 1/4"sq. (6.35mm)
	Quick spinner 1/4"sq. (6.35mm)
	Hex key wrench: H2.5, 3, 4, 5, 6, 8mm
	1/4"sockets: H5, 5.5, 6, 7, 8, 9, 10, 11, 12, 13, 14mm

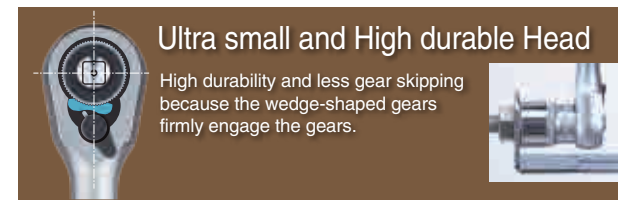

## WOOD-COMPO™ Ratchet Handle

- High durability and less gear skipping by firmly engaging wedge-shaped gears
- Reliable operation as the hand firmly holds the grip from the moment you start fastening

1/4"sq. (6.35mm)



Model No.	□	⌘	⌘	⌘	⌘(mm)	Code
HRH2W	6.35(1/4")	20	20	30	145	162004

3/8"sq. (9.5mm)



Model No.	□	⌘	⌘	⌘	⌘(mm)	Code
HRH3W	9.5(3/8")	25	27	30	180	162005

## WOOD-COMPO™ Socket Wrench Set

1/4"sq. (6.35mm) / 3/8"sq. (9.5mm) 36pcs.



Model No. / Code	Set Contents
HRW2303MW	Wood-compo ratchet handle 3/8"sq. (9.5mm)
162003	Wood-compo spinner handle 1/4"sq. (6.35mm)
	Universal socket adaptor 3/8"sq. (9.5mm)
	Extension bar Overall length 150mm 1/4"sq. (6.35mm)
	Bit socket adaptor 1/4"sq. ⇄ 1/4"hex.
	1/4"sockets: 4, 4.5, 5, 5.5, 6, 7, 8mm
	3/8"sockets: 10, 11, 12, 13, 14, 17, 19, 21, 22mm
	Bits: ⊖ 4, 6, ⊕ 1, 2, 3, H3, H4, H5, H6, T10, T15, T20, T25, T30, T40

## WOOD-COMPO™ Swivel Socket Wrench Set

3/8"sq. (9.5mm) 16pcs.



Model No. / Code	Set Contents
HRW3005MSW	Wood-compo swivel ratchet handle 3/8"sq. (9.5mm)
162103	Extension bar Overall length 55mm 3/8"sq. (9.5mm)
	Quick spinner 3/8"sq. (9.5mm)
	Deep socket 3/8"sq. (9.5mm): H8, 10, 12, 14mm
	3/8"sockets: H8, 10, 12, 13, 14, 17, 19, 21, 24mm

## WOOD-COMPO™ Socket Wrench Set

1/4"sq. (6.35mm) 36pcs.



Model No. / Code	Set Contents
HRW2001MW	Wood-compo ratchet handle 1/4"sq. (6.35mm)
162001	Wood-compo stubby handle 1/4"sq. (6.35mm)
	Universal socket adaptor 1/4"sq. (6.35mm)
	Extension bar Overall length 100mm 1/4"sq. (6.35mm)
	Bit socket adaptor 1/4"sq. ⇄ 1/4"hex.
	1/4"sockets: 4, 4.5, 5, 5.5, 6, 7, 8, 9, 10, 11, 12, 13, 14mm
	Bits: ⊖ 4, 6, ⊕ 1, 2, 3, H1.5, H2, H2.5, H3, H4, H5, T10, T15, T20, T25, T27, T30, T40

## WOOD-COMPO™ Socket Wrench Set

3/8"sq. (9.5mm) 16pcs.



Model No. / Code	Set Contents
HRW3002MW	Wood-compo ratchet handle 3/8"sq. (9.5mm)
162002	Universal socket adaptor 3/8"sq. (9.5mm)
	Sliding T-shaped handle 3/8"sq. (9.5mm)
	Extension bar Overall length 150mm 3/8"sq. (9.5mm)
	Extension bar Overall length 75mm 3/8"sq. (9.5mm)
	3/8" sockets: 7, 8, 10, 11, 12, 13, 14, 17, 19, 21, 22mm









# "L-KEY" Wrenches

## VESSEL's Advanced Technology

The ball point tip-end is designed to be extracted smoothly even if it contacts with obstacles while tightening screws. It does not get caught or trapped in the hexagon screw head.

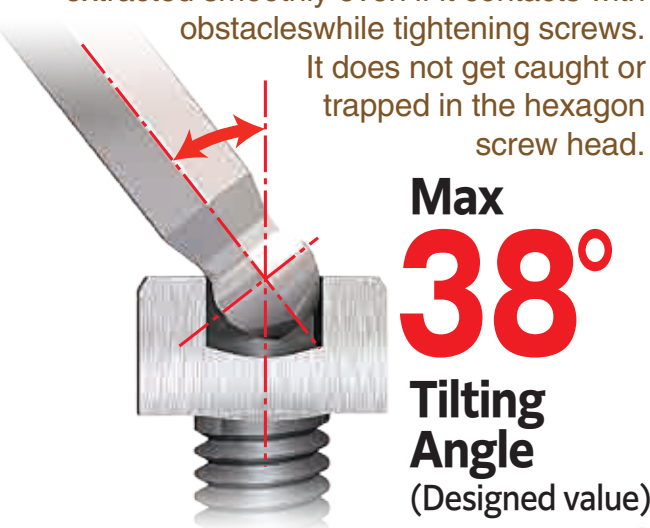

**Max Tilting Angle 38°**  
(Designed value)

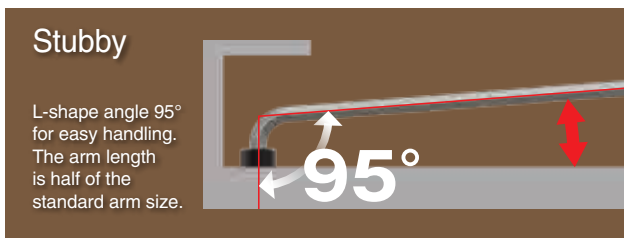
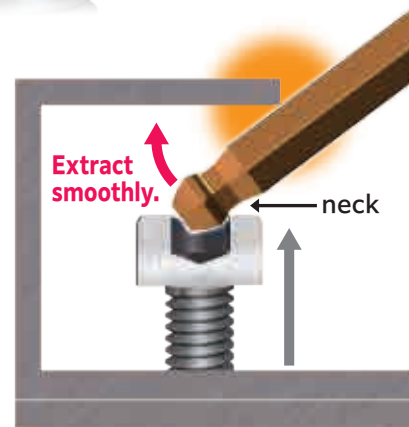

### Ball Point Wrench Stubby (Short Type) 9-pc set

- Stubby ideal for cramped space
- L-shape angle 95° for easy handling



Model No. / Code	Set Contents
8209BPSU 143878	Ball Point Wrench Stubby (Short Type) ● 1.5, 2, 2.5, 3, 4, 5, 6, 8, 10 mm Carded Holder

### Ball Point Wrench Stubby 9-pc set

- Stubby ideal for cramped space
- L-shape angle 95° for easy handling



Model No. / Code	Set Contents
8209BPU 143879	Ball Point Wrench Stubby ● 1.5, 2, 2.5, 3, 4, 5, 6, 8, 10 mm Carded Holder

### Ball Point Wrench Stubby (Long Type) 9-pc set

- Stubby ideal for cramped space
- L-shape angle 95° for easy handling



Model No. / Code	Set Contents
8209BPLU 143880	Ball Point Wrench Stubby (Long Type) ● 1.5, 2, 2.5, 3, 4, 5, 6, 8, 10 mm Carded Holder

### Ball Point Wrench 9-pc set

Model No. / Code	Set Contents
8309BPU 143881	Ball Point Wrench ● 1.5, 2, 2.5, 3, 4, 5, 6, 8, 10 mm Carded Holder

### Ball Point Wrench (Long Type) 9-pc set

Model No. / Code	Set Contents
8309BPLU 143882	Ball Point Wrench (Long Type) ● 1.5, 2, 2.5, 3, 4, 5, 6, 8, 10 mm Carded Holder

**Extra Long** Ball point can reach deep spaces. Also, it is possible to apply force on the arm end.



### Ball Point Wrench (Extra Long Type) 9-pc set

Model No. / Code	Set Contents
8309BPXLU 143883	Ball Point Wrench (Extra Long Type) ● 1.5, 2, 2.5, 3, 4, 5, 6, 8, 10 mm Carded Holder

### Ball Point Wrench (Long Type) (Inch) 9-pc set

Model No. / Code	Set Contents
8309BPLINU 143884	Ball Point Wrench (Long Type) (Inch) ● 1/16, 5/64, 3/32, 1/8, 5/32, 3/16, 1/4, 5/16, 3/8 inch Carded Holder

## Quick Tightening at tilted angle

Ball-shaped TORX wrench can tighten screws quickly even at a tilted angle. It is ideal for a work in a cramped space such as automotive maintenance.



**Max Tilting Angle 25°**  
(Designed value)

## Tamper-proof TORX® system

Tamper-proof TORX screw has a protrusion in the center of the screw recess that cannot be tightened or loosened with a standard TORX screwdriver.

\*Not applicable for non-standard TORX screws



**TORX®**

Tip-end processing based on TORX standards. Corresponds to various screws.

### Ball End TORX Wrench 9-pc set

Model No. / Code	Set Contents
8509BTXU 143885	Ball End TORX Wrench ● T8, T9, T10, T15, T20, T25, T27, T30, T40 mm Carded Holder

### Tamper-proof TORX Wrench 9-pc set

Model No. / Code	Set Contents
8509TXHU 143886	Tamper-proof TORX Wrench ● T8H, T9H, T10H, T15H, T20H, T25H, T27H, T30H, T40H mm Carded Holder

Resistant to twist and breaking  
**Extra Superalloy**

**Made in Japan**

### VESSEL's Unique Steel Material

- Wear resistant material hardness.
- Rust resistant.
- Fully hardened.
- Magnetized.



Special alloy material also used in VESSEL's bits for impact screwdrivers. Special Heat treatment revealing superior material characteristics.

220USB SERIES
MEGADORA SCREWDRIVER
BALL GRIP SCREWDRIVER
SUPER CUSHION SCREWDRIVER
WOOD COMPO SERIES
FOR ELECTRONICS TOOLS/ USEFUL TOOLS
DRIVER SET SERIES
OTHER HAND TOOLS
L-WRENCH
IMPACT BALL
NECK-TORSION
DRYWALLER/ QB
INSERT BITS
POWER BITS
POWER BITS/ MAG CATCHER
DOUBLE-ENDED POWER BITS
NUT SETTERS
Bit Holder
PRECISION BITS



## DRIVER BIT

# WITHSTANDING HIGH IMPACT!

# IMPACT BALL™ Screwdriver Bit



**VoHA**  
Highest Hardness HRC 62  
Using New Alloy Steel "VoHA" Highest Hardness 62 HRC

**2 way use of Insert and Power!**  
Impact Ball™ 30mm (1 3/16") is applicable to Power Tools directly and also to Bit Holder.

### IMPACT BALL™ Torsion Bit

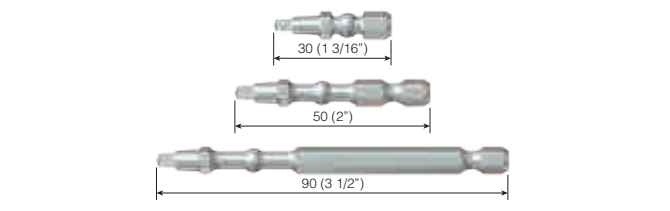

Model No.		mm	inch	Pack QTY		Code
IBSQ130P2	■ SQ1	30	1 3/16"	2	Carded	426037
IBSQ130P25K	SQ1	30	1 3/16"	25	Bulk	426071
IBSQ230P2	SQ2	30	1 3/16"	2	Carded	426038
IBSQ230P25K	SQ2	30	1 3/16"	25	Bulk	426072
IBSQ330P2	SQ3	30	1 3/16"	2	Carded	426039
IBSQ330P25K	SQ3	30	1 3/16"	25	Bulk	426073
IBSQ250P25K	SQ2	50	2"	25	Bulk	426088
IBSQ290P10K	SQ2	90	3 1/2"	10	Bulk	426089

### IMPACT BALL™ Torsion Bit

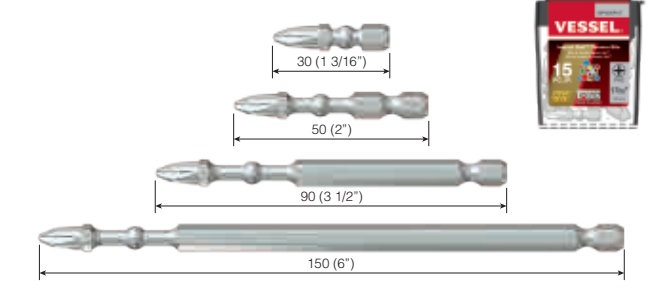

Model No.		mm	inch	Pack QTY		Code
IBPH130P2	⊕ PH1	30	1 3/16"	2	Carded	426030
IBPH130P25K	PH1	30	1 3/16"	25	Bulk	426065
IBPH230P2	PH2	30	1 3/16"	2	Carded	426031
IBPH230P5	PH2	30	1 3/16"	5	Carded	426033
IBPH230P25K	PH2	30	1 3/16"	25	Bulk	426066
IBPH230P15T	PH2	30	1 3/16"	15	TicTac	426102
IBPH330P2	PH3	30	1 3/16"	2	Carded	426032
IBPH330P25K	PH3	30	1 3/16"	25	Bulk	426067
IBPH150P25K	PH1	50	2"	25	Bulk	426083
IBPH250P25K	PH2	50	2"	25	Bulk	426084
IBPH250P15T	PH2	50	2"	15	TicTac	426593
IBPH350P25K	PH3	50	2"	25	Bulk	426085
IBPH290P10K	PH2	90	3 1/2"	10	Bulk	426086
IBPH2150P10K	PH2	150	6"	10	Bulk	426087

### IMPACT BALL™ Torsion Bit

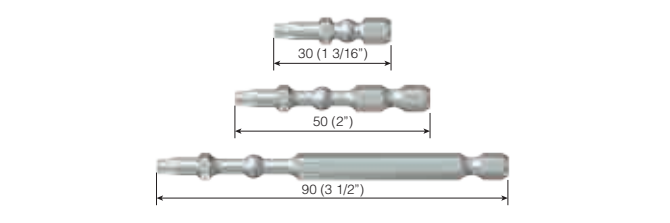

Model No.		mm	inch	Pack QTY		Code
IBTX1030P25K	⊛ T10	30	1 3/16"	25	Bulk	426090
IBTX1530P2	T15	30	1 3/16"	2	Carded	426034
IBTX1530P25K	T15	30	1 3/16"	25	Bulk	426068
IBTX2030P2	T20	30	1 3/16"	2	Carded	426035
IBTX2030P25K	T20	30	1 3/16"	25	Bulk	426069
IBTX2530P2	T25	30	1 3/16"	2	Carded	426036
IBTX2530P25K	T25	30	1 3/16"	25	Bulk	426070
IBTX3030P25K	T30	30	1 3/16"	25	Bulk	426091
IBTX1050P25K	T10	50	2"	25	Bulk	426092
IBTX1550P25K	T15	50	2"	25	Bulk	426093
IBTX2050P25K	T20	50	2"	25	Bulk	426094
IBTX2550P25K	T25	50	2"	25	Bulk	426095
IBTX3050P25K	T30	50	2"	25	Bulk	426096
IBTX2090P10K	T20	90	3 1/2"	10	Bulk	426097
IBTX2590P10K	T25	90	3 1/2"	10	Bulk	426098

220USB SERIES
MEGADORA SCREWDRIVER
BALL GRIP SCREWDRIVER
SUPER CUSHION SCREWDRIVER
WOOD COMPO SERIES
FOR ELECTRONICS TOOLS/ USEFUL TOOLS
DRIVER SET SERIES
OTHER HAND TOOLS
L-WRENCH
IMPACT BALL
NECK-TORSION
DRYWALLER/ QB
INSERT BITS
POWER BITS
POWER BITS/ MAG CATCHER
DOUBLE-ENDED POWER BITS
NUT SETTERS
Bit Holder
PRECISION BITS

# IMPACT BALL™ Screwdriver Bit

## Mag Charge!

Easy Magnetizing and Demagnetizing by friction.

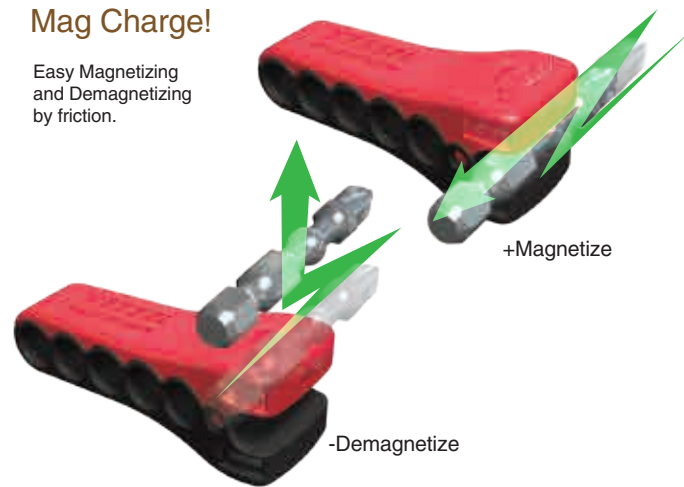

### IMPACT BALL™ Torsion Bit with Mag Charge Holder

Model No. / Code

IBMG50PH2K5	⊕ (5)PH2	50	2"	Holder
426077				

### IMPACT BALL™ Torsion Bit with Mag Charge Holder

Model No. / Code

IBMG50K001	⊕ (1)PH1, (3)PH2, (1)PH3	50	2"	Holder
426078				

### IMPACT BALL™ Torsion Bit with Mag Charge Holder

Model No. / Code

IBMG50K002	⊕ (1)T10, (1)T15, (1)T20, (1)T25, (1)T30	50	2"	Holder
426079				

### IMPACT BALL™ Torsion Bit with Mag Charge Holder

Model No. / Code

IBMG50K003	⊕ (2)PH2	50	2"	Holder
426080	■ (1)SQ2			
	⊕ (1)T20, (1)T25			

### IMPACT BALL™ Torsion Bit with Mag Charge Holder

Model No. / Code

IBMG30K002	⊕ (1)T10, (1)T15, (1)T20, (1)T25, (1)T30	30	1 3/16"	Holder
426076				

### IMPACT BALL™ Torsion Bit with Mag Charge Holder

Model No. / Code

IBMG90PH2K5	⊕ (5)PH2	90	3 1/2"	Holder
426081				

### IMPACT BALL™ Torsion Bit with Mag Charge Holder

Model No. / Code

IBMG90K001	⊕ (1)PH1, (1)PH2, (1)PH3	90	3 1/2"	Carded
426121	⊖ (1)SL4, (1)SL6			

### IMPACT BALL™ Torsion Bit with Mag Charge Holder

Model No. / Code

IBMG90K002	⊕ (1)PH2, ⊖ (1)SL6, ■ (1)SQ2, ⊕ (1)T20, T25	90	3 1/2"	Carded
426122				

### IMPACT BALL™ Torsion Bit with Mag Charge Holder

Model No. / Code

IBMG90K003	⊕ (1)PH2, PH3	90	3 1/2"	Carded
426123	■ (1)SQ1, SQ2, SQ3			

### IMPACT BALL™ Torsion Bit with Mag Charge Holder

Model No. / Code

IBMG150PH2K5	⊕ (5)PH2	150	6"	Holder
426082				

### IMPACT BALL™ Torsion Bit Holder

• Holding bits with a C-ring and a strong magnetic force



Model No.	mm	inch	Pack QTY		Code
IBHBM67P1	67	2 5/8"	1	Hanger	426111
IBHBM67P10K	67	2 5/8"	10	Bulk	426099
IBHBM150P1	150	6"	1	Hanger	426112
IBHBM150P10K	150	6"	10	Bulk	426100
IBHBM300P1	300	12"	1	Hanger	426113
IBHBM300P10K	300	12"	10	Bulk	426101

### IMPACT BALL™ Torsion Bit 10+1 PC. Set in POP-UP CASE



Model No. / Code	Set Contents	mm	inch
IB11P02U	⊕ (1)PH1, (1)PH2, (1)PH3		
426114	⊖ (1)SL6		
	■ (1)SQ2	30	1 3/16"
	⊕ (1)T10, (1)T15, (1)T20		
	(1)T25, (1)T30		
	Magnet Bit Holder 60mm		

### IMPACT BALL™ Torsion Bit 30+1 PC. Set in SLIDE CASE



Model No. / Code	Set Contents	mm	inch
IB31P02U	⊕ (1)PH1, (1)PH2, (1)PH3		
426115	⊕ (1)PZ1, (1)PZ2, (1)PZ3		
	⊖ (1)SL4, (1)SL6, (1)SL8		
	■ (1)SQ1, (1)SQ2, (1)SQ3		
	⊕ (1)T10, (1)T15, (1)T20, (1)T25, (1)T27, (1)T30, (1)T40	30	1 3/16"
	⊕ (1)H3, (1)H4, (1)H5, (1)H6, (1)H3/32, (1)H7/64, (1)H1/8, (1)H9/64, (1)H3/16, (1)H7/32, (1)H1/4"		
	Magnet Bit Holder 50mm		

# NECK TORSION™ Screwdriver Bit

**MEGADORA SCREWDRIVER**

**BALL GRIP SCREWDRIVER**

**SUPER CUSHION SCREWDRIVER**

**WOOD COMPO SERIES**

**FOR ELECTRONICS TOOLS/ USEFUL TOOLS**

**DRIVER SET SERIES**

**OTHER HAND TOOLS**

**L-WRENCH**

**IMPACT BALL**

The reduced shank makes screw head visible. It's optimum to the fastening application in a narrow space.

**Shock Absorption**

**TORSION ZONE**

**10x TOUGH™**

**VoHA**  
Highest Hardness HRC62

Using New Alloy Steel "VoHA" Highest Hardness 62 HRC

**NECK TORSION™ Insert Bit**

Magnetic

25.4 (1")

Model No.		mm	inch	Pack QTY		Code
NNTX10254P25K	T10	25.4	1"	25	Bulk	426045
NNTX15254P3	T15	25.4	1"	3	Carded	426005
NNTX15254P25K	T15	25.4	1"	25	Bulk	426046
NNTX20254P3	T20	25.4	1"	3	Carded	426006
NNTX20254P25K	T20	25.4	1"	25	Bulk	426047
NNTX25254P3	T25	25.4	1"	3	Carded	426007
NNTX25254P25K	T25	25.4	1"	25	Bulk	426048
NNTX30254P25K	T30	25.4	1"	25	Bulk	426049

**NECK TORSION™ Power Bit**

Magnetic

50 (2")

Model No.		mm	inch	Pack QTY		Code
NTPH150P2	PH1	50	2"	2	Carded	426017
NTPH150P25K	PH1	50	2"	25	Bulk	426053
NTPH250P2	PH2	50	2"	2	Carded	426018
NTPH250P5	PH2	50	2"	5	Carded	426022
NTPH250P25K	PH2	50	2"	25	Bulk	426054
NTPH350P2	PH3	50	2"	2	Carded	426021
NTPH350P25K	PH3	50	2"	25	Bulk	426055
NTPH275P2	PH2	75	3"	2	Carded	426019
NTPH275P10K	PH2	75	3"	10	Bulk	426062
NTPH2150P1	PH2	150	6"	1	Carded	426020
NTPH2150P10K	PH2	150	6"	10	Bulk	426063

**NECK-TORSION™ Insert Bit**

Magnetic

25.4 (1")

Model No.		mm	inch	Pack QTY		Code
NTPH1254P3	PH1	25.4	1"	3	Carded	426001
NTPH1254P25K	PH1	25.4	1"	25	Bulk	426042
NTPH2254P3	PH2	25.4	1"	3	Carded	426002
NTPH2254P5	PH2	25.4	1"	5	Carded	426004
NTPH2254P25K	PH2	25.4	1"	25	Bulk	426043
NTPH2254P25T	PH2	25.4	1"	25	TicTac	426041
NTPH3254P3	PH3	25.4	1"	3	Carded	426003
NTPH3254P25K	PH3	25.4	1"	25	Bulk	426044

**NECK TORSION™ Power Bit**

Magnetic

50 (2")

Model No.		mm	inch	Pack QTY		Code
NTSQ150P2	SQ1	50	2"	2	Carded	426026
NTSQ150P25K	SQ1	50	2"	25	Bulk	426059
NTSQ250P2	SQ2	50	2"	2	Carded	426027
NTSQ250P25K	SQ2	50	2"	25	Bulk	426060
NTSQ350P2	SQ3	50	2"	2	Carded	426028
NTSQ350P25K	SQ3	50	2"	25	Bulk	426061

**NECK TORSION™ Insert Bit**

Magnetic

25.4 (1")

Model No.		mm	inch	Pack QTY		Code
NTSQ1254P3	SQ1	25.4	1"	3	Carded	426008
NTSQ1254P25K	SQ1	25.4	1"	25	Bulk	426050
NTSQ2254P3	SQ2	25.4	1"	3	Carded	426009
NTSQ2254P25K	SQ2	25.4	1"	25	Bulk	426051
NTSQ3254P3	SQ3	25.4	1"	3	Carded	426010
NTSQ3254P25K	SQ3	25.4	1"	25	Bulk	426052

**NECK TORSION™ Power Bit**

Magnetic

50 (2")

Model No.		mm	inch	Pack QTY		Code
NNTX1550P2	T15	50	2"	2	Carded	426023
NNTX1550P25K	T15	50	2"	25	Bulk	426056
NNTX2050P2	T20	50	2"	2	Carded	426024
NNTX2050P25K	T20	50	2"	25	Bulk	426057
NNTX2550P2	T25	50	2"	2	Carded	426025
NNTX2550P25K	T25	50	2"	25	Bulk	426058

**Double-Ended Bit is Our Invention.**

2 in 1, Even when one side fails, the other side is drivable.

**20x TOUGH™**

**NECK TORSION™ Double-Ended Power Bit**

Magnetic

50 (2")

Model No.		mm	inch	Pack QTY		Code
DEPH1PH150P2	PH1	50	2"	2	Carded	426011
DEPH2PH250P2	PH2	50	2"	2	Carded	426012
DEPH3PH350P2	PH3	50	2"	2	Carded	426013
DEPH2PH250P5	PH2	50	2"	5	Carded	426016

**NECK TORSION™ Double-Ended Power Bit**

Magnetic

50 (2")

Model No.		mm	inch	Pack QTY		Code
DEPH2SQ250P2	PH2/SQ2	50	2"	2	Carded	426015

**NECK TORSION™ Double-Ended Power Bit**

Magnetic

50 (2")

Model No.		mm	inch	Pack QTY		Code
DEPH2TX2550P2	PH2/T25	50	2"	2	Carded	426014

**Stable fastening in a hollow place**

**20x TOUGH™**

Suitable in a hollow application with a long reach  
Stable fastening with supportive plastic spring

**RIB REINFORCED NECK TORSION™ Power Bit**

Magnetic

150 (6")

Model No.		mm	inch	Pack QTY		Code
RTPH2150P1	PH2	150	6"	1	Carded	426040
RTPH2150P10K	PH2	150	6"	10	Bulk	426064

**NEW TicTac case**

The package that is easy to take out bits

**NECK TORSION™ Power Bits with MAG ENHANCER™**

Magnetic

50 (2")

Model No.		mm	inch	Pack QTY		Code
MGEPH250P10T	PH2	50	2"	10	TicTac	426105

**NECK TORSION™ Power Bits with MAG ENHANCER™**

Magnetic

50 (2")

Model No.		mm	inch	Pack QTY		Code
MGETX1550P10T	T15	50	2"	10	TicTac	426106
MGETX2050P10T	T20	50	2"	10	TicTac	426107
MGETX2550P10T	T25	50	2"	10	TicTac	426108
MGETX3050P10T	T30	50	2"	10	TicTac	426109
MGETX4050P10T	T40	50	2"	10	TicTac	126110

**Catch a screw by strong magnetic force**

Magnetized bits get weakened by heat and vibration from work. Attaching Mag Enhancer maintains the magnetic force. Its holding power has 15 times more magnetic force.

**Magnetic Force X15**

1/4 6.35mm 1/4 6.35mm \*Applicable to smaller diameter than 1/4 inch

**MAG ENHANCER™**

Magnetic

19 (0.75") 21 (0.83")

Model No.		mm	inch	Pack QTY		Code
MGEP2		21	0.83"	2	Blister	426103
MGEP25DSP		21	0.83"	25	TRAY	426104

# Drywaller™ Screwdriver BIT/ Ball Grip™ Carrying Bit Holder

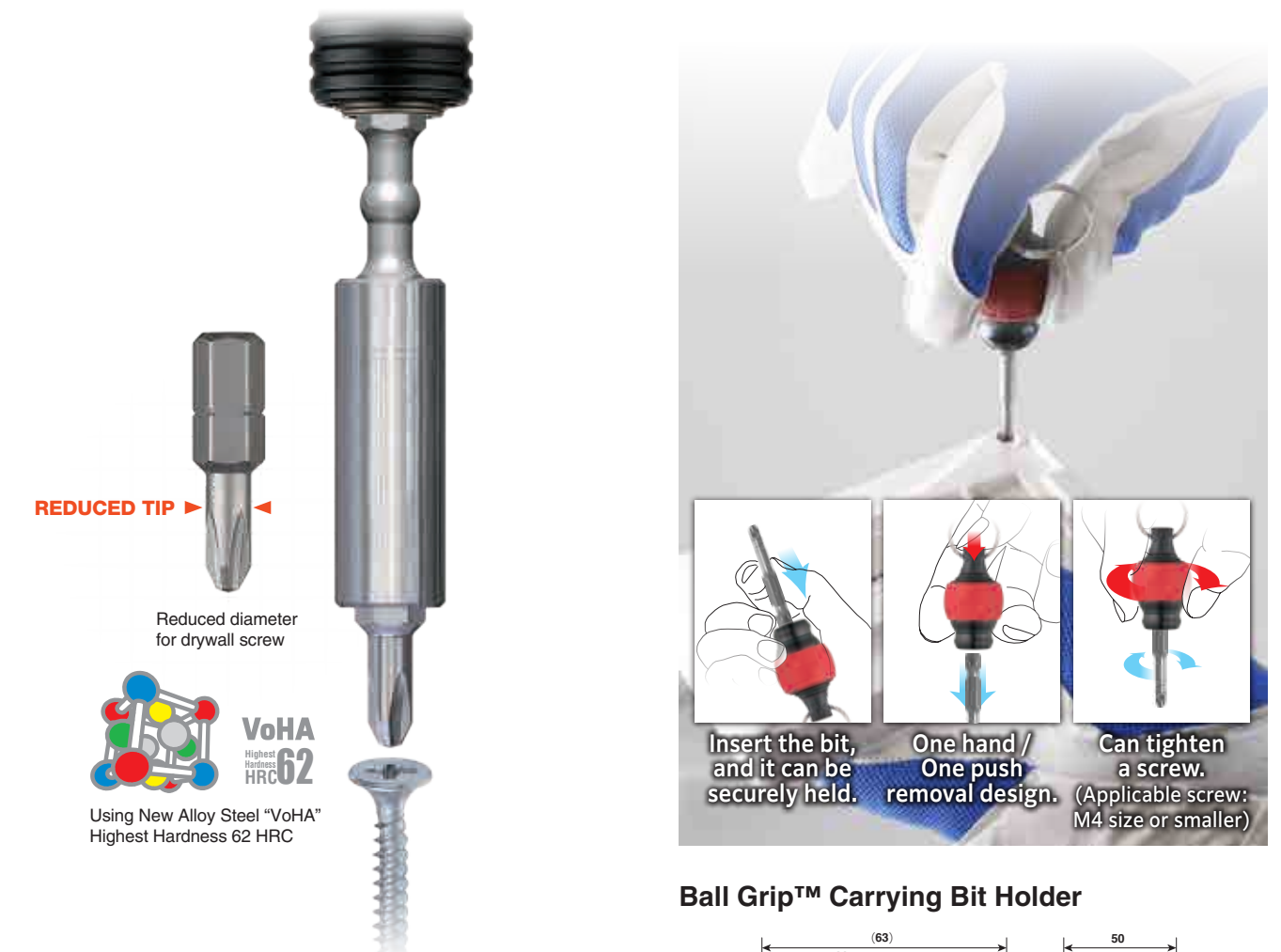

**REDUCED TIP**

Reduced diameter for drywall screw



Using New Alloy Steel "VoHA" Highest Hardness 62 HRC

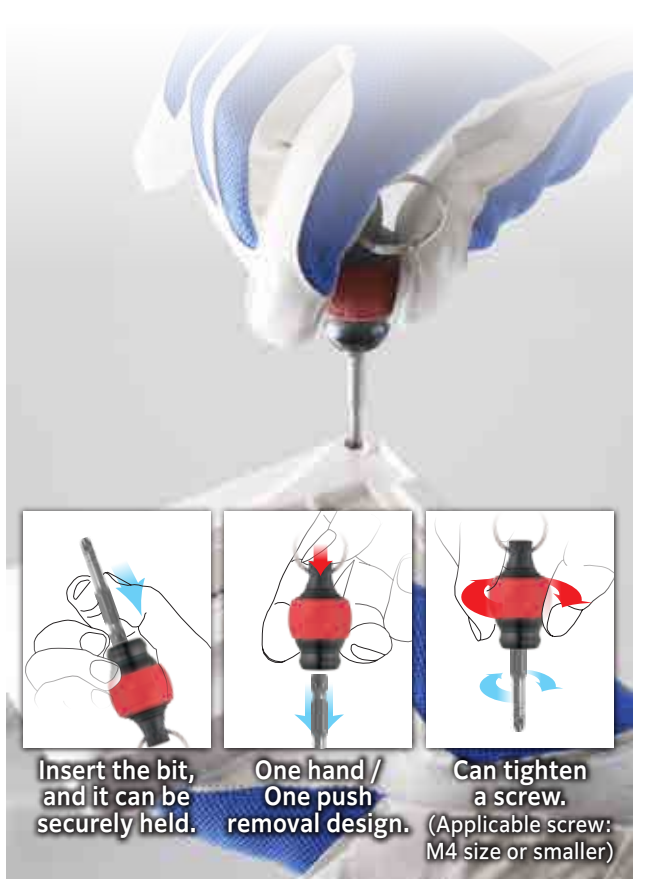

Insert the bit, and it can be securely held.

One hand / One push removal design.

Can tighten a screw. (Applicable screw: M4 size or smaller)

## Ball Grip™ Carrying Bit Holder



Model No.	Contents	Inner Ctn.	Code
QB22RU	Red x 1	1PC/CARDED	486937
QB22GU	Green x 1	1PC/CARDED	486939
QB22VU	Violet x 1	1PC/CARDED	486940
QB22YU	Yellow x 1	1PC/CARDED	486938
QB22KU	Black x 1	1PC/CARDED	487043



Good visibility at the bit tip and superior wear resistance

## DRYWALLER™ Insert Bit



Magnetic

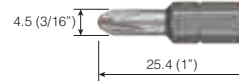

Model No.	mm	inch	Pack QTY	Code
DWPH2254P3	25.4	1"	3	426118
DWPH2254P25K	25.4	1"	25	426116
DWPH2254P20T	25.4	1"	20	426119

# VESSEL Counter Display

## IMPACT BALL™ Torsion Bits with Mag Charge Holder Counter Display

No.	Model No.	Description
1	IBMG30PH2K5	PH2 x 30 x 5PC. (MG Holder)
2	IBMG30K001	PH1, PH2, PH3, SQ2, SQ3 x 5PC. (MG Holder)
3	IBMG30K002	T10, T15, T20, T25, T30 x 30 x 5PC. (MG Holder)
4	IBMG50PH2K5	PH2 x 50 x 5PC. (MG Holder)
5	IBMG50K001	PH1, PH2, PH2, PH2, PH3 x 50 x 5PC. (MG Holder)
6	IBMG50K002	T10, T15, T20, T25, T30x 50 x 5PC. (MG Holder)
7	IBMG90PH2K5	PH2 x 90 x 5PC. (MG Holder)
8	IBMG150PH2K5	PH2X150 x 5PC. (MG Holder)
9	IBHBM67P10K	Torsion Bit Holder H1/4" x 67 x 10PC. (Bulk)
10	IBHBM150P10K	Torsion Bit Holder H1/4" x 150 x 10PC. (Bulk)
11	IBHBM300P10K	Torsion Bit Holder H1/4" x 300 x 10PC. (Bulk)

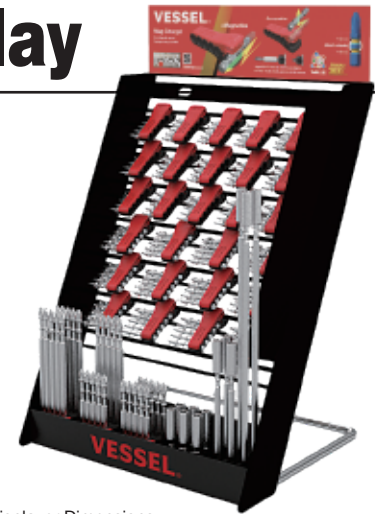

Displayer Dimensions: W11.8"(30cm) x D11"(27.8cm) x H18.3"(46.6cm)

## IMPACT BALL™ Torsion Bits with Mag Charge Holder Counter Display



Displayer Dimensions: W9"(23cm) x D10.8"(27.5cm) x H7.9"(20cm)

No.	Model No.	Description
1	IBPH230P15T	PH2 x 30 x 15PC.
2	IBPH250P15T-DSP	IBPH250P15T x 15Pack

## NECK TORSION™ Insert Bits Tic Tac Case Counter Display

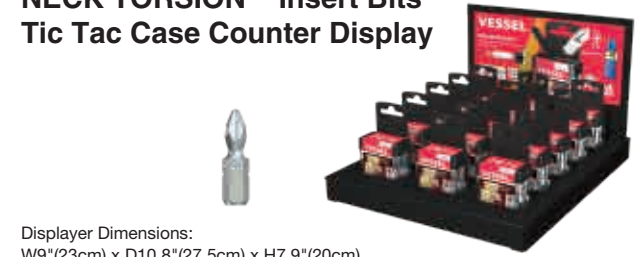

Displayer Dimensions: W9"(23cm) x D10.8"(27.5cm) x H7.9"(20cm)

No.	Model No.	Description
1	NTPH2254P25T	PH2 x 25.4 x 25PC.

## DRYWALLER™ Insert Bits Tic Tac Case Counter Display



Display Dimensions: W9"(23cm) x D10.8"(27.5cm) x H7.9"(20cm)

No.	Model No.	Description
1	DWPH2254P20T-DSP	DWPH2254P20T x 15Pack

## NECK TORSION™ Power Bits with Mag ENHANCER™ Tic Tac Case Counter Display



Displayer Dimensions: W9"(23cm) x D10.8"(27.5cm) x H7.9"(20cm)

No.	Model No.	Description
1	MGEPH250P10T/D	MGEPH250P10T x 15Pack
2	MGETX/SET2	MGETX1550P10T x 5Pack
		MGETX2050P10T x 5Pack
		MGETX2550P10T x 5Pack

No.	Model No.	Description
3	MGETX/SET4	MGETX1550P10T x 5Pack
		MGETX3050P10T x 5Pack
		MGETX4050P10T x 5Pack
		MGETX2550P10T x 5Pack

## MAG ENHANCER™ 25PC. Counter Display



No.	Model No.	Description
1	MGEP25-DSP	Mag Enhancer x 25PC.

## MAG ENHANCER™

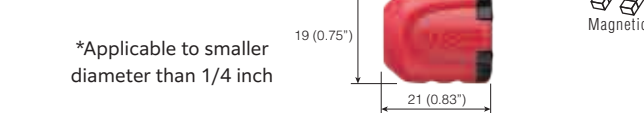

Model No.	Overall Length	Inner Ctn.	Code
MGEP2	21	2PC/CARDED	426103
MGEP25-DSP	21	25PC/TRAY	426104



# A Long Lasting Technology

Breakage of a screwdriver bit not only reduces work efficiency but also adversely affects the quality of an assembled product. Improving durability of a screwdriver bit is a critical issue for assembly lines.

## Pursuit of Durability

Alloy Steel including substances such as C, Si, Ni, Cr, Mo, and V, which gives a high hardness and toughness, is heat treated by our own furnace and technology in order to make our screwdriver bits outstanding quality and durability.

“VoHA” steel is compounded a special alloy element used for materials in aerospace industry. Combination with NECK TORSION™ technology, it is possible to dramatically reduce the breakage of the bit tip.



Reducing screw fastening cost

To avoid a broken bit tip stuck in a screw head



**VoHA**

VESSEL Outstanding High-Performance Alloy  
World Toughest VoHA steel material  
Highest Durability Bit was born

## Tip Toughness Test

Torsion force is increased until failure and to show the highest torque value.

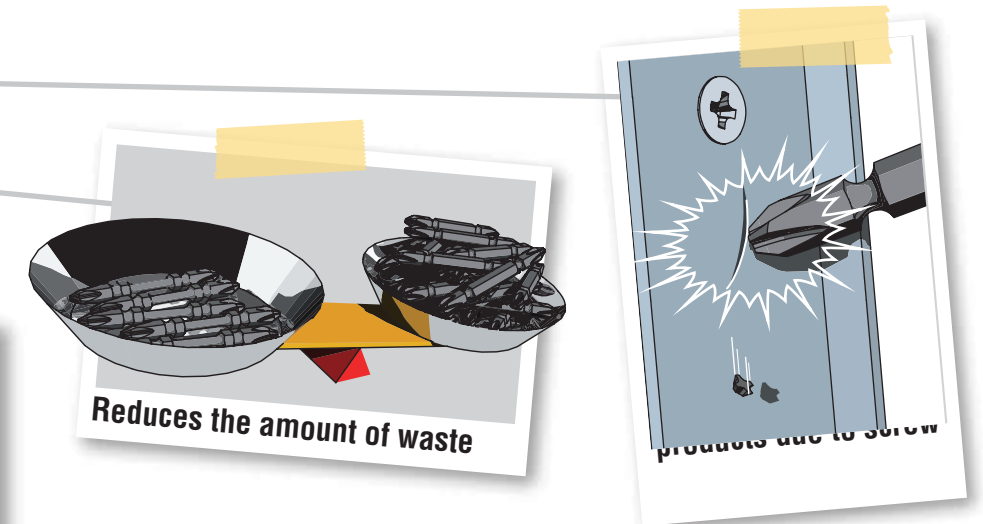
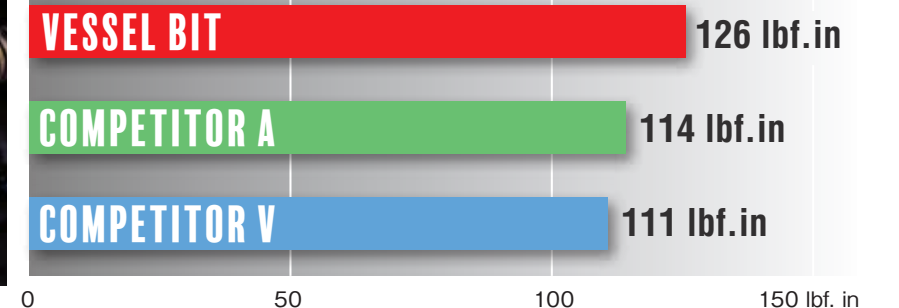

## Precision Fitting

Screwdriver bits are produced with less variation by improvement of machining accuracy with superior machines and thorough quality control. The tip profile is thoroughly analyzed for fitting well with screws using a 3D digitizer.

Ideal fitting not only prevents stripping a screw head but also improves the durability of screwdriver bit.



## Selecting Phillips tip according to hardness classification

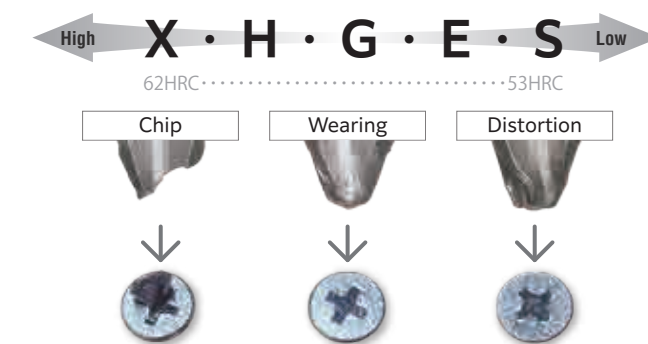

Easy to fracture when a bit is higher than optimum hardness  
Easy to wear-out or distort when a bit is lower than optimum hardness

## Mag Applied Technology

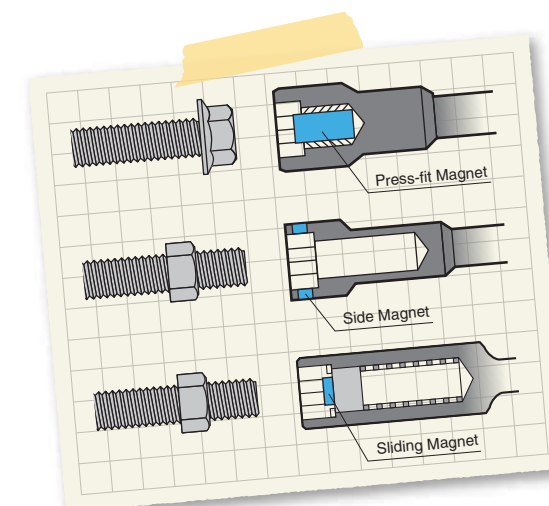

Hold a screw with strong magnetic force. Magnet applied technology is a significantly effective tools for the prevention of screw fall-off during work. A wide variety of products are offered depending upon each work application.















SINCE 1973

# PNEUMATIC TOOLS FOR PROFESSIONALS

 MADE IN JAPAN

**VESSEL Co., Inc.**  
Osaka Japan  
[spair.vessel.co.jp/english/](http://spair.vessel.co.jp/english/)

**VESSEL TOOLS U.S.A., INC.**  
[www.spairusa.com/](http://www.spairusa.com/)





# Impact Ratchet Wrench

## Three times as fast as a standard air ratchet!

The impact mechanism is built into the air ratchet wrench, so that it can be tightened by the power of impact.

- It is safer because there is little backlash when tightening is completed.
- The rotation speed is more than Three times as fast as that of a normal ratchet, which makes tightening and loosening fast and easy.
- The speed of tightening can be adjusted by the built-in air regulator on the top rear of the tool.



### SP-1764HD

1/4" SUPER FAST MINI IMPACT RATCHET  
**700rpm/ 55ft-lbs.**

- Impact Mechanism [Patented].
- Built-in Power Regulator.
- Single Dog Clutch.



**Super Fast**



Scan to watch Demo Video

### SP-1765HD

3/8" SUPER FAST MINI IMPACT RATCHET  
**700rpm/ 55ft-lbs.**

**700rpm/55ft-lbs.**

### SP-7730

3/8" REACTION FREE HIGH SPEED IMPACT RATCHET  
**450rpm/ 100ft-lbs.**

- Impact Mechanism [Patented].
- Built-in Power Regulator.
- Reverse Lever.
- Single Dog Clutch.



**High Torque**



- Sealed Head for Long Life.
- Impact Mechanism [Patented].
- Built-in Power Regulator.
- Single Dog Clutch.



Scan to watch Demo Video

### SP-7265RP

3/8" THE PERFECT IMPACT RATCHET  
**600rpm/ 45ft-lbs.**



Sealed Flat Ratchet Mechanism



# Ratchet Wrench



### SP-7260

1/4" SEALED FLAT HEAD MINI RATCHET  
**290rpm/ 25ft-lbs.**

- Sealed Head for Long Life.
- Reverse Lever for One-handed operation.
- Air Regulator.
- Swivel Air Inlet with 360° Exhaust Sleeve.



Sealed Flat Ratchet Mechanism

**Light Weight**



### SP-7265

3/8" SEALED FLAT HEAD MINI RATCHET  
**290rpm/ 25ft-lbs.**

#### SP-7265W

3/8" WOBBLE ANVIL SEALED FLAT HEAD MINI RATCHET

### SP-7780

3/8" HEAVY-DUTY SEALED FLAT HEAD RATCHET WRENCH [SHORT VERSION]  
**200rpm/ 80ft-lbs.**

**High Power**

- Sealed Head for Long Life.
- Reverse Lever for One-handed operation.
- Air Regulator.
- 360° Exhaust Sleeve.



Sealed Flat Ratchet Mechanism



### SP-7250H

**290rpm/ 25ft-lbs.**

LOW PROFILE 1/4" HEX. BIT DRIVER

- Sealed Head for Long Life.
- Reverse Lever for One-handed operation.
- Air Regulator.
- Swivel Air Inlet with 360° Exhaust Sleeve.

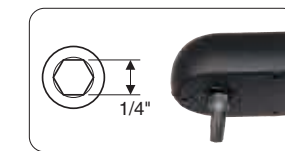

Broken Bit Knock Out Access



- Low profile for use in tight areas.
- Use with any 1/4" drive bit.
- Ratchet style for ease of use.

### SP-7770

1/4" ROTATIONAL HEAD RATCHET WRENCH  
**220rpm/ 25ft-lbs.**

- Reverse Lever.
- Built-in Air Regulator.
- Swivel Air Inlet and Rear Air Exhaust.



- To adjust head, slide the ring forward and turn the ratchet housing.



### SP-7772

3/8" ROTATIONAL HEAD RATCHET WRENCH  
**220rpm/ 25ft-lbs.**

Model No.	Sq. Drive	Bolt Capacity	Max. Torque	Free Speed	Overall Length	Net Weight	Sound Level
SP-7260	1/4"	5/16"	25 ft-lbs.	290 rpm	8"	1.5 lbs.	87 dB
SP-7265	3/8"	3/8"	25 ft-lbs.	290 rpm	8"	1.5 lbs.	87 dB
SP-7265W	3/8"	3/8"	25 ft-lbs.	290 rpm	8"	1.5 lbs.	87 dB
SP-7770	1/4"	5/16"	25 ft-lbs.	220 rpm	7.9"	1.3 lbs.	82 dB
SP-7772	3/8"	3/8"	25 ft-lbs.	220 rpm	7.9"	1.3 lbs.	82 dB
SP-7780	3/8"	3/8"	80 ft-lbs.	200 rpm	9.75"	3.5 lbs.	82.6 dB

Model No.	Hex. Drive	Max. Torque	Free Speed	Overall Length	Net Weight	Sound Level
SP-7250H	1/4"	25 ft-lbs.	290 rpm	8"	1.5 lbs.	82 dB

Model No.	Sq. Drive	Bolt Capacity	Max. Torque	Free Speed	Overall Length	Net Weight	Sound Level
SP-1764HD	1/4"	5/16"	55 ft-lbs.	700 rpm	6.9"	1.4 lbs.	84.4 dB
SP-1765HD	3/8"	3/8"	55 ft-lbs.	700 rpm	6.9"	1.4 lbs.	84.4 dB
SP-7260RP	1/4"	5/16"	45 ft-lbs.	600 rpm	7.5"	1.6 lbs.	88.1 dB
SP-7265RP	3/8"	3/8"	45 ft-lbs.	600 rpm	7.5"	1.6 lbs.	88.1 dB
SP-7730	3/8"	3/8"	100 ft-lbs.	450 rpm	11.6"	3.1 lbs.	88.2 dB

# Impact Wrench



## SP-1140EX

1/2" HEAVY DUTY IMPACT WRENCH

- Built-in Power Regulator.
- Twin Dog Clutch.



**Twin Dog Clutch**

- Twin dog clutch provides more power and smooth balanced blows.
- Produced 800ft-lbs. of bolt removing torque.
- Visual forward regulator with 4 torque settings and one full power reverse setting.

## SP-7144

1/2" COMPOSITE IMPACT WRENCH



**Twin Dog Clutch**



**SAS (Side And Side) System**  
Forward / Reverse for one hand operation.



**Air Regulator**  
4 torque setting and full power reverse.

- Composite body greatly reduces weight to allow longer, fatigue free, operation when compared to heavier models with comparable torque and speed specifications.

## SP-1140EXL

1/2" HEAVY DUTY IMPACT WRENCH w/ 2" EXTEND ANVIL

## SP-7146EX

1/2" COMPOSITE MINI IMPACT WRENCH



**Twin Dog Clutch**



**SAS (Side And Side) System**  
Forward / Reverse for one hand operation.



**Air Regulator**  
4 torque setting. *Ultralight*

## SP-7825

3/8" COMPOSITE MINI IMPACT WRENCH



**Double Hammer Clutch**



**SAS (Side And Side) System**  
Forward / Reverse for one hand operation.



**Air Regulator**  
4 torque setting. *Ultralight*

## SP-1850

3/8" PALM IMPACT WRENCH



**Double Hammer Clutch**



**Air Regulator**  
4 torque setting. *Palm Size*

## SP-7146EXS

3/8" COMPOSITE MINI IMPACT WRENCH



## SP-7825S

1/4" COMPOSITE MINI IMPACT WRENCH



## SP-7150-V8

3/4" COMPOSITE IMPACT WRENCH



**Twin Dog Clutch**

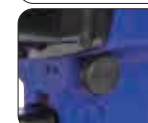

**SAS (Side And Side) System**  
Forward / Reverse for one hand operation.



**Air Regulator**  
4 torque setting.

- Eight vane motor delivers hard-hitting torque of more than 1,000 ft-lbs.
- while housed in a composite housing weighing less than 8 lbs.

## SP-1158

3/4" IMPACT WRENCH



**Single Dog Clutch**



**Air Regulator**  
Forward, Reverse buton with 5 torque setting.

## SP-1193GE-6

1" IMPACT WRENCH

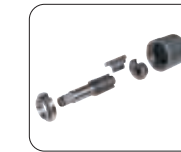
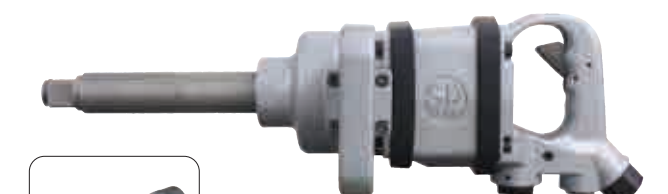

**Pinless Hammer Clutch**



**Air Regulator**  
Forward, Reverse torque setting.

## SP-1194DX-6

1" IMPACT WRENCH



**Twin Dog Clutch**  
Twin dog clutch assembly operates within an oil bath to provide long life and reduced noise.



**Air Regulator**  
4 torque setting.

Model No.	Sq. Drive	Bolt Capacity	Max. Torque	Free Speed	Overall Length	Net Weight	Sound Level
SP-1140EX	1/2"	5/8"	800 ft-lbs.	6,000 rpm	7.5"	5.7 lbs.	88.8 dB
SP-1140EXL	1/2"	5/8"	800 ft-lbs.	6,000 rpm	9.5"	6.6 lbs.	88.8 dB
SP-7144	1/2"	5/8"	(F) 750 ft-lbs. (R) 800 ft-lbs.	(F) 5,700 rpm (R) 6,500 rpm	6.1"	4.0 lbs.	93.1 dB
SP-7146EX	1/2"	5/8"	440 ft-lbs.	10,000 rpm	5.2"	2.1 lbs.	93.1 dB
SP-7146EXS	3/8"	1/2"	380 ft-lbs.	10,000 rpm	5.2"	2.1 lbs.	93.1 dB
SP-7825	3/8"	3/8"	94 ft-lbs.	17,000 rpm	4.3"	1.5 lbs.	84.2 dB
SP-7825S	1/4"	3/8"	94 ft-lbs.	17,000 rpm	4.3"	1.5 lbs.	84.2 dB
SP-1850	3/8"	3/8"	72 ft-lbs.	10,000 rpm	5.4"	1.0 lbs.	87.4 dB
SP-1850S	1/4"	3/8"	72 ft-lbs.	10,000 rpm	5.4"	1.0 lbs.	87.4 dB

Model No.	Sq. Drive	Bolt Capacity	Max. Torque	Free Speed	Overall Length	Net Weight	Sound Level
SP-7150-V8	3/4"	1"	1,100 ft-lbs.	4,300 rpm	9.3"	7.9 lbs.	94.9 dB
SP-1158	3/4"	1"	1,200 ft-lbs.	5,500 rpm	8.7"	12.0 lbs.	93.5 dB
SP-1193GE-6	1"	1-1/2"	2,300 ft-lbs.	4,000 rpm	22.0"	28.7 lbs.	98.0 dB
SP-1194DX-6	1"	1-1/2"	1,800 ft-lbs.	4,800 rpm	20.6"	17.2 lbs.	96.7 dB

# Cut-off Tool

## SP-7230

CUT-OFF TOOL (DISC SIZE : 3")



- Ergonomic design cushion-grip handle.
- Rear exhaust. Safety throttle lever.
- Built-in power regulator.
- Direct drive motor. Graduated trigger.
- Metal guard. Cuts muffler clamps and hangers, sheet metal, radiator hose clamps, bumper bolts, and even steel rods up to 3/4".

## SP-7231

FLEX HEAD CUT-OFF TOOL (DISC SIZE : 3")

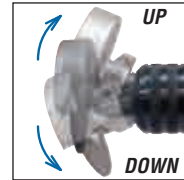

3-POSITION FLEX HEAD



- Built-in Power Regulator.
- Rear Exhaust.
- Safety Throttle Lever.

## SP-7231R

REVERSIBLE FLEX HEAD CUT-OFF TOOL (DISC SIZE : 3")

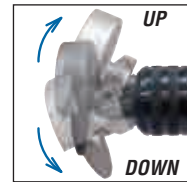

3-POSITION FLEX HEAD



**Reversible**

- Built-in Power Regulator.
- Rear Exhaust.
- Safety Throttle Lever.
- Reverse Lever.

## 7231AWC

ADJUSTABLE WHEEL COVER

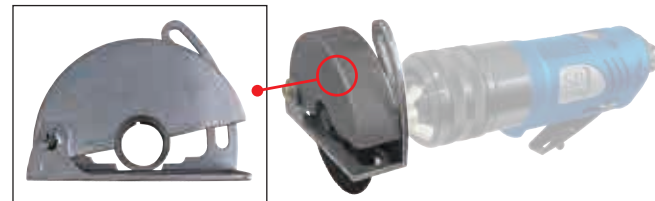

Fits SP AIR model # SP-7231, SP-7231R.  
Fits also MAC AT35A (Mac Brand)  
Adjustable cut depth ( Minimum 1/8")

Model No.	Disc Size	Free Speed	Overall Length	Net Weight	Sound Level
SP-7230	3"	20,000 rpm	6-3/4"	1.5 lbs.	90.0 dB
SP-7231	3"	18,000 rpm	8.6"	2.6 lbs.	90.0 dB
SP-7231R	3"	12,000 rpm	8.8"	2.8 lbs.	90.0 dB

# Reciprocating Saw/ Disk Grinder



## SP-7234

4" EXTENDED REACH CUT-OFF TOOL

- Long Shaft.
- Wheel Cover.
- Safety Lever.
- Built-in Power Regulator.
- Rear Exhaust.



### Accessories

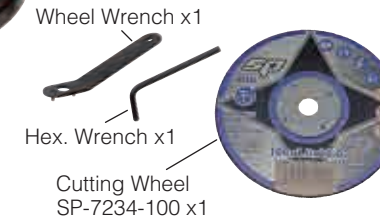

## SP-7610

RECIPROCATING SAW [GEAR TYPE]

- Adjustable Blade Guide.
- Safety Lever.
- Air Regulator.
- Cutting Capacity 5/32".



### Tool Cutaway



Scan to watch Demo Video

### Option

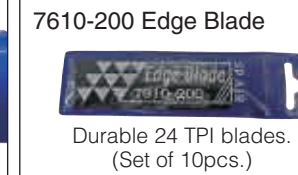

7610-200 Edge Blade  
Durable 24 TPI blades.  
(Set of 10pcs.)

### Accessories



Model No.	Disc Size	Free Speed	Overall Length	Net Weight	Sound Level
SP-7234	4"	14,000 rpm	13.8"	3.3 lbs.	88.8 dB
SP-1257	5"	12,000 rpm	9.3"	3.7 lbs.	86.0 dB

Model No.	Strokes/min.	Stroke	Overall Length	Net Weight	Sound Level
SP-7610	5,300	0.47"	8.15"	1.3 lbs.	86.5 dB
SP-7620	7,500	0.24"	6.1"	1.0 lbs.	86.5 dB

## SP-1257

5" ANGLE DISC GRINDER [LEVER TYPE]



- Built-in governor mechanism.
- Safety lever.
- Handle grip mounts on either side for right or left hand operation.
- Hardened and ground spiral bevel gears for lower vibration.

## SP-7620

SHORT RECIPROCATING SAW [GEAR TYPE]

- Blade Guide.
- Safety Lever.
- Air Regulator.
- Cutting Capacity 5/64".

**Compact Body**



# Die Grinder



## SP-7220

1/4" HEAVY-DUTY STRAIGHT DIE GRINDER



- Ergonomic design cushion-grip handle.
- Rear exhaust.
- Built-in power regulator.
- Safety throttle lever.
- Direct drive motor with graduated trigger.

## SP-7212

1/4" HEAVY-DUTY 120 degree ANGLE HEAD DIE GRINDER



- 120 degree Angle head.
- Ergonomic design cushion-grip handle.
- Rear exhaust.
- Built-in power regulator.
- Safety throttle lever.

## SP-7211

1/4" HEAVY-DUTY 90 degree ANGLE HEAD DIE GRINDER



- Ergonomic design cushion-grip handle. Rear exhaust.
- Built-in power regulator.
- Safety throttle lever.

## SP-1900

1/8" MICRO GRINDER



- Rear exhaust.
- Flexible 59" long hose.

Model No.	Disc Size	Free Speed	Overall Length	Net Weight	Sound Level
SP-7220	1/4"	20,000 rpm	6-7/8"	1.37 lbs.	90.1 dB
SP-7211	1/4"	18,000 rpm	6-7/8"	1.75 lbs.	87.8 dB
SP-7212	1/4"	18,000 rpm	6-5/8"	1.69 lbs.	86.8 dB
SP-1900	1/4"	70,000 rpm	6" (w/o hose)	0.9 lbs. (w/o hose)	78.3 dB

## SP-7200

1/4" STRAIGHT DIE GRINDER



- Ergonomic design cushion-grip handle.
- Swivel Air Inlet with 360° Exhaust Sleeve.
- Built-in power regulator.
- Safety throttle lever.
- Direct drive motor with graduated trigger.

## SP-7201

1/4" ANGLE HEAD DIE GRINDER



- 90 degree corner type.
- Anti-vibration ultra-soft grip.
- Easy adjustment of the regulator.
- Swivel inlet and exhaust.

## SP-7202

1/4" ANGLE HEAD DIE GRINDER



- 120 degree corner type.
- Safety throttle lever.
- Urethane covered cushion grip.
- Built-in power regulator.
- 360 degrees rotating rear exhaust.

Model No.	Disc Size	Free Speed	Overall Length	Net Weight	Sound Level
SP-7200	1/4"	23,000 rpm	6"	0.88 lbs	82.0 dB
SP-7201	1/4"	20,000 rpm	6-3/8"	1.25 lbs	82.4 dB
SP-7202	1/4"	20,000 rpm	7.6"	1.23 lbs	83.0 dB

## SP-4BS

CARBIDE BURR 4pc SET FOR FERROUS MATERIALS

- For use with 1/4" High Speed Die Grinders.
- For use in metalworking, mold and pattern making, die sinking, surface cleaning and maintenance.
- Removes Burrs from Sheet metal or cast iron.
- Cleans up welding areas.



### CARBIDE BURRS

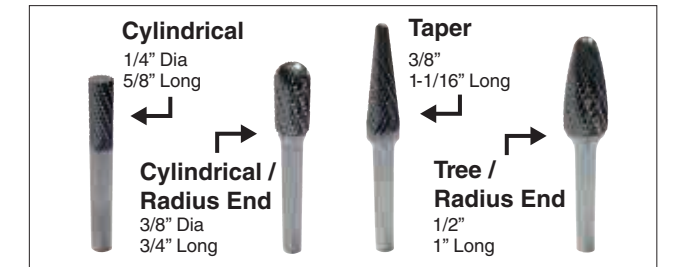

## SP-4NF

CARBIDE BURR 4pc SET FOR ALUMINUM / NON-FERROUS MATERIALS

- Allowing rapid stock removal on nonferrous and plastics materials.
- Avoiding clogging.
- Ensures smooth cutting operation.
- Giving a guaranteed smoother grinding operation.



### CARBIDE BURRS

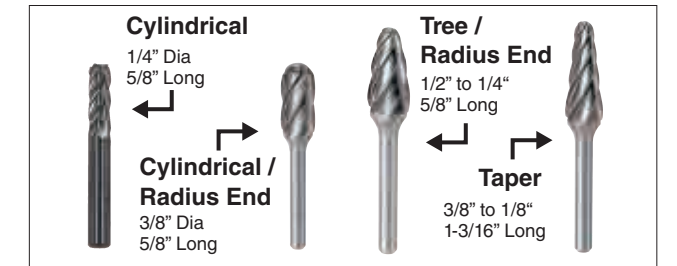

# Beveler

## SP-7252F

AIR MINI BEVELER  
[STRAIGHT]

## SP-7252FR

AIR MINI BEVELER  
[RADIUS]

**Palm Size**



- Safety Throttle Lever.
- Front Exhaust for cooling metal.



Scan to watch  
Demo Video

- Use the Palm Beveler to; Clean up the welds, Beveling steel or aluminum edges for Custom work, Automotive, Motorcycles, Marine and Aircraft uses.
- 45° Straight and Radius Blade available.

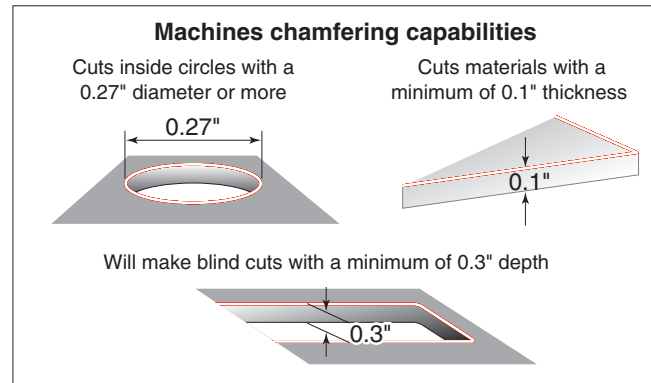
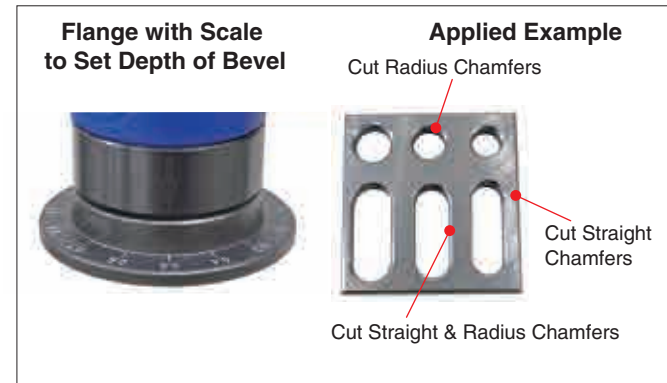
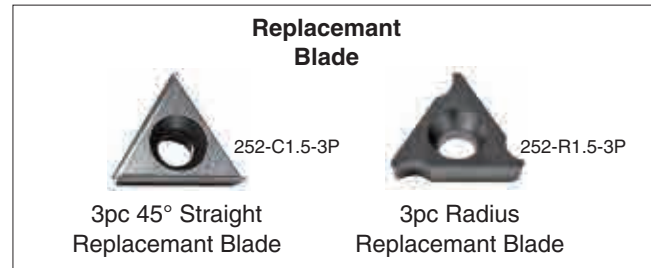
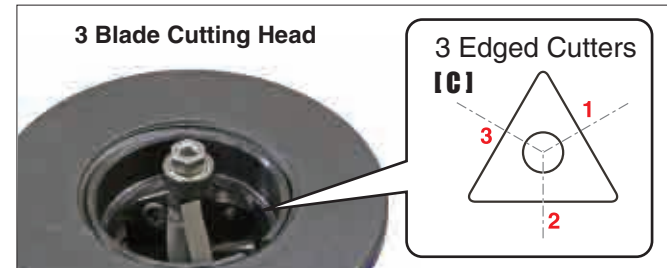

Model No.	Min. Diameter	Chamfering Capacity	Free Speed	Overall Length	Net Weight	Sound Level
SP-7252F	0.27"	C45° 0.06"	23,000 rpm	4.4"	0.9 lbs.	81.5 dB
SP-7252FR	0.27"	R0.06"	23,000 rpm	4.4"	0.9 lbs.	81.5 dB

# Sander/ Polisher



## SP-1350

5" HIGH SPEED SANDER

- Handle Exhaust with Silencer.
- Rubber Cover.



**Compact and Lightweight**

## SP-7201DA

2" MINI D/A SANDER

- Swivel Air Inlet with 360° Exhaust Sleeve.



**Compact and Lightweight**

2" SANDING DISC 180 GRIT  
25 Pack #7201DA-18025P  
50 Pack #7201DA-18050P  
100 Pack #7201DA-180100P

2" SANDING DISC 320 GRIT  
25 Pack #7201DA-32025P  
50 Pack #7201DA-32050P  
100 Pack #7201DA-320100P

## SP-7500AHM

3" MINI POLISHER

- Swivel Air Inlet with 360° Exhaust Sleeve.
- Spindle Size: 5/16-24UNF.
- Air Regulator.

LOW SPEED  
SINGLE ACTION

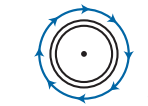

- Well Balanced.
- More Powerful.
- Wide Range of Uses.
- Polish Small Areas.
- Polish Complex Shapes.

## 3" 100% Twist Wool Pad



Model No.	Disc Size	Free Speed	Overall Length	Net Weight	Sound Level
SP-1350	3" & 5"	15,000 rpm	5"	2.1 lbs.	77.8 dB
SP-7201DA	2"	12,000 rpm	6.3"	1.3 lbs.	87.9 dB
SP-7500AHM	3"	2,500 rpm	7.9"	1.7 lbs.	85.8 dB

Model No.	Belt Size	Free Speed	Overall Length	Net Weight	Sound Level
SP-1370A	3/8 & 1/2" x 13"	16,000 rpm	11"	1.7 lbs.	82.0 dB
SP-1380	3/4" x 20-1/2"	17,000 rpm	14.4"	3.1 lbs.	85.5 dB

## SP-1370A

3/8" & 1/2" x 13" BELT SANDER

- Quick change belt guide allows belt replacement in seconds.

Rotate 160°

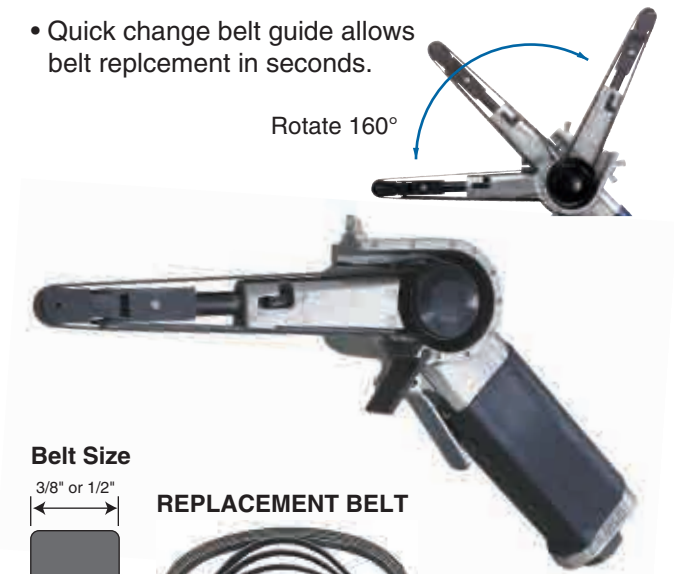

Belt Size

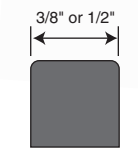

REPLACEMENT BELT



370-80-5P (60 Grit 3/8"x13")  
Replacement Belt 5 Pack  
370-80-10P (60 Grit 3/8"x13")  
Replacement Belt 10 Pack

## SP-1380

3/4" x 20-1/2" BELT SANDER



Belt Size

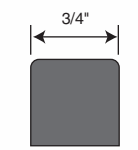

REPLACEMENT BELT



380-60-5P (60 Grit 3/4"x20.5")  
Replacement Belt 5 Pack  
380-60-10P (60 Grit 3/4"x20.5")  
Replacement Belt 10 Pack

# Air Drill

## SP-7527

1/2" COMPOSITE AIR DRILL

**400rpm**

- 1/2"(13mm) Drill Chuck.
- Light Weight Composite Body.



**Double Gear Mechanism**  
For Short body



**SAS (Side And Side) System**  
Forward / Reverse  
for one hand operation.



**Air Exhaust with Muffler**

## SP-7527KL

1/2" COMPOSITE AIR DRILL [KEYLESS CHUCK]

**400rpm**

- 1/2"(13mm) Keyless Drill Chuck.
- Light Weight Composite Body.



**Double Gear Mechanism**  
For Short body



**SAS (Side And Side) System**  
Forward / Reverse  
for one hand operation.



**Air Exhaust with Muffler**

## SP-1523D

3/8" STRAIGHT DRILL / TIRE BUFFER

- Precision drill chuck.
- Lever type.
- Right rotation only.



# Air Impact Driver



## SP-7825HU

1/4" HEX. COMPOSITE IMPACT DRIVER

1/4" Hexagonal

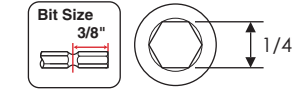

**Ultralight**



**Double Hammer Clutch**



**SAS (Side And Side) System**  
Forward / Reverse  
for one hand operation.



**Air Regulator**  
4 torque setting.



## SP-8102BU

1/4" HEX. IMPACT DRIVER

1/4" Hexagonal

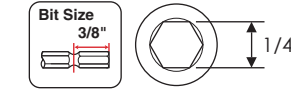

**Double Hammer Clutch**



**Reverse Lever**



**Air Regulator**  
4 torque setting.



## SP-7146HX

1/4" HEX. COMPOSITE IMPACT DRIVER

1/4" Hexagonal



**Ultralight**



**Double Hammer Clutch**

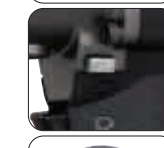

**SAS (Side And Side) System**  
Forward / Reverse  
for one hand operation.



**Air Regulator**  
4 torque setting.



Model No.	Chuck Size	Free Speed	Overall Length	Net Weight	Sound Level
SP-7527	1/2"	400 rpm	7"	2.9 lbs.	86.8 dB
SP-7527KL	1/2"	400 rpm	7.1"	2.9 lbs.	86.8 dB
SP-1523D	3/8"	3,800 rpm	7.5"	1.59 lbs.	83.0 dB

Model No.	Hex. Drive	Max. Torque	Free Speed	Overall Length	Net Weight	Sound Level
SP-7825HU	1/4"	94 ft.-lbs.	17,000 rpm	4.7"	1.5 lbs.	85.5 dB
SP-7146HX	1/4"	100 ft.-lbs.	8,500 rpm	5.3"	2.1 lbs.	92.0 dB
SP-8102BU	1/4"	100 ft.-lbs.	11,500 rpm	6"	2.6 lbs.	90.0 dB

# Air Hammer

## SP-1400

LONG BARREL AIR HAMMER



- For industrial and auto repair applications.
- Ideal for general cutting, body panel crimping, shearing, rust/paint removal, chipping and scraping.
- Comfortable non-slip ergonomic grip.
- Graduated trigger control.
- Built-in air regulator.
- Quick change coil spring retainer allows for fast and easy chisel changes.
- Handle exhaust.

## SP-1405

SHORT BARREL AIR HAMMER

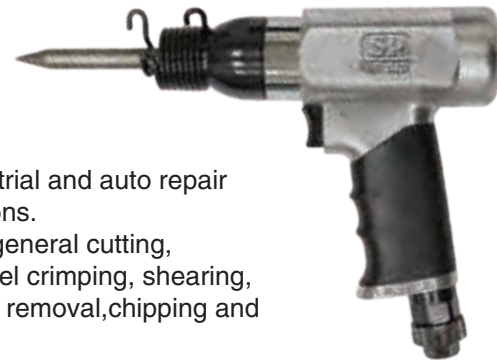

- For industrial and auto repair applications.
- Ideal for general cutting, body panel crimping, shearing, rust/paint removal, chipping and scraping.
- Comfortable non-slip ergonomic grip.
- Graduated trigger control.
- Built-in air regulator.
- Quick change coil spring retainer allows for fast and easy chisel changes.
- Handle exhaust.

## SP-1410

AIR HAMMER



- Variable speed trigger.
- Built-in regulator.
- Quick change coil spring retainer allows for fast and easy chisel changes.

## SP-1410K

AIR HAMMER KIT

### Accessories

- Sheet metal chisel
- Flat chisel
- Tapered punch chisel
- Spot welder chisel



Model No.	Shank Size	Free Speed	Overall Length	Net Weight	Sound Level
SP-1400	0.4"	2,100 rpm	8.5"	3.6 lbs.	96 dB
SP-1405	0.4"	3,000 rpm	6.5"	2.6 lbs.	100 dB
SP-1410/ SP-1410K	0.4"	3,000 rpm	8.5"	3.6 lbs.	96 dB

# Needle Scaler

## SP-1460

NEEDLE SCALER [SMALL]



## SP-1470

NEEDLE SCALER [LARGE]

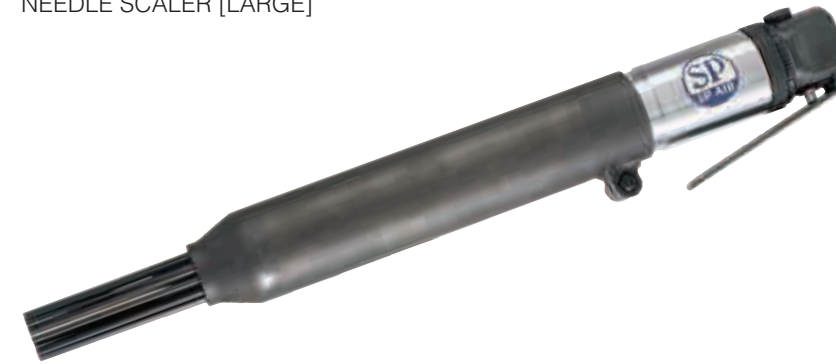

Model No.	Bore	Stroke	Needle	Blows/min.	Overall Length	Net Weight	Vibration Level A
SP-1460	3/4"	1/2"	1/8" x 12 pcs	5,000	9"	2.8 lbs.	27.87 m/s <sup>2</sup>
SP-1470	1"	7/8"	1/8" x 19 pcs	4,000	16"	5.7 lbs.	31.68 m/s <sup>2</sup>